

European Technical Approval ETA-13/0185

English translation prepared by DIBt - Original version in German language

Handelsbezeichnung
Trade name

Schrauben zur Befestigung von Sandwichpaneelen BiGHTY SWPS
Fastening screws for sandwich panels BiGHTY SWPS

Zulassungsinhaber
Holder of approval

E.u.r.o. Tec GmbH
Unter dem Hofe 5
58099 Hagen
DEUTSCHLAND

Zulassungsgegenstand
und Verwendungszweck
*Generic type and use
of construction product*

Schrauben zur Befestigung von Sandwichpaneelen
Fastening screws for sandwich panels

Geltungsdauer:
Validity: vom
from
bis
to

23 April 2013
23 April 2018

Herstellwerke
Manufacturing plants

Herstellerwerk 1, Herstellerwerk 10
Manufacturing plant 1, Manufacturing plant 10

Diese Zulassung umfasst
This Approval contains

21 Seiten einschließlich 13 Anhänge
21 pages including 13 annexes

I LEGAL BASES AND GENERAL CONDITIONS

- 1 This European technical approval is issued by Deutsches Institut für Bautechnik in accordance with:
 - Council Directive 89/106/EEC of 21 December 1988 on the approximation of laws, regulations and administrative provisions of Member States relating to construction products¹, modified by Council Directive 93/68/EEC² and Regulation (EC) N° 1882/2003 of the European Parliament and of the Council³;
 - *Gesetz über das In-Verkehr-Bringen von und den freien Warenverkehr mit Bauprodukten zur Umsetzung der Richtlinie 89/106/EWG des Rates vom 21. Dezember 1988 zur Angleichung der Rechts- und Verwaltungsvorschriften der Mitgliedstaaten über Bauprodukte und anderer Rechtsakte der Europäischen Gemeinschaften (Bauproduktengesetz - BauPG) vom 28. April 1998⁴, as amended by Article 2 of the law of 8 November 2011⁵;*
 - Common Procedural Rules for Requesting, Preparing and the Granting of European technical approvals set out in the Annex to Commission Decision 94/23/EC⁶.
- 2 Deutsches Institut für Bautechnik is authorized to check whether the provisions of this European technical approval are met. Checking may take place in the manufacturing plant. Nevertheless, the responsibility for the conformity of the products to the European technical approval and for their fitness for the intended use remains with the holder of the European technical approval.
- 3 This European technical approval is not to be transferred to manufacturers or agents of manufacturers other than those indicated on page 1, or manufacturing plants other than those indicated on page 1 of this European technical approval.
- 4 This European technical approval may be withdrawn by Deutsches Institut für Bautechnik, in particular pursuant to information by the Commission according to Article 5(1) of Council Directive 89/106/EEC.
- 5 Reproduction of this European technical approval including transmission by electronic means shall be in full. However, partial reproduction can be made with the written consent of Deutsches Institut für Bautechnik. In this case partial reproduction has to be designated as such. Texts and drawings of advertising brochures shall not contradict or misuse the European technical approval.
- 6 The European technical approval is issued by the approval body in its official language. This version corresponds fully to the version circulated within EOTA. Translations into other languages have to be designated as such.

¹ Official Journal of the European Communities L 40, 11 February 1989, p. 12
² Official Journal of the European Communities L 220, 30 August 1993, p. 1
³ Official Journal of the European Union L 284, 31 October 2003, p. 25
⁴ *Bundesgesetzblatt Teil I 1998*, p. 812
⁵ *Bundesgesetzblatt Teil I 2011*, p. 2178
⁶ Official Journal of the European Communities L 17, 20 January 1994, p. 34

II SPECIFIC CONDITIONS OF THE EUROPEAN TECHNICAL APPROVAL

1 Definition of product/ products and intended use

1.1 Definition of the construction product

The fastening screws for sandwich panels are self drilling screws listed in Table 1. The fastening screws for sandwich panels are made of stainless steel or case hardened carbon steel. They are completed with metallic washers and EPDM sealing rings. For details see the appropriate Annexes.

Screws or washers for which the stainless steel grade A2 according to EN ISO 3506-1 is given in the respective Annexes (e. g. 1.4301 or 1.4567) may be made of stainless steel grade A4 (e. g. 1.4401 or 1.4578) as well.

Examples of fastening screws for sandwich panels and a corresponding connection are shown in Annex 1.

The fastening screws for sandwich panels and the corresponding connections are subject to tension and shear forces.

Table 1 Different types of the fastening screws for sandwich panels

Annex	Fastening screw	Description
Annex 2	BiGHTY SWPS BIM DSS 6,3/5,5 x L	with hexagon head and sealing washer $\geq \text{Ø}14$ mm
Annex 3	BiGHTY SWPS BIM DSS 6,3/5,5 x L	with hexagon head and sealing washer $\geq \text{Ø}16$ mm
Annex 4	BiGHTY SWPS BIM DSS 6,3/5,5 x L	with hexagon head and sealing washer $\geq \text{Ø}19$ mm
Annex 5	BiGHTY SWPS DSS 6,3/5,5 x L	with hexagon head and sealing washer $\geq \text{Ø}14$ mm
Annex 6	BiGHTY SWPS DSS 6,3/5,5 x L	with hexagon head and sealing washer $\geq \text{Ø}16$ mm
Annex 7	BiGHTY SWPS DSS 6,3/5,5 x L	with hexagon head and sealing washer $\geq \text{Ø}19$ mm
Annex 8	BiGHTY SWPS BIM DSS 6,3/5,5 x L	with hexagon head and sealing washer $\geq \text{Ø}14$ mm
Annex 9	BiGHTY SWPS BIM DSS 6,3/5,5 x L	with hexagon head and sealing washer $\geq \text{Ø}16$ mm
Annex 10	BiGHTY SWPS BIM DSS 6,3/5,5 x L	with hexagon head and sealing washer $\geq \text{Ø}19$ mm
Annex 11	BiGHTY SWPS DSS 6,3/5,5 x L	with hexagon head and sealing washer $\geq \text{Ø}14$ mm
Annex 12	BiGHTY SWPS DSS 6,3/5,5 x L	with hexagon head and sealing washer $\geq \text{Ø}16$ mm
Annex 13	BiGHTY SWPS DSS 6,3/5,5 x L	with hexagon head and sealing washer $\geq \text{Ø}19$ mm

1.2 Intended use

The fastening screws for sandwich panels are intended to be used for fastening of flat, lightly profiled or profiled sandwich panels to metal supporting structures and as far as stated in Table 1 to timber supporting structures. The core material of the sandwich panel shall be made of polystyrene (PS) - or polyurethane (PUR) – ridged foam or mineral wool with a minimum compression resistance of the core material of 0.04 N/mm² (according to the specifications to the sandwich elements for instance in the CE-marking). The sandwich panels can either be used as wall or as roof cladding.

The component to be fastened is component I and the supporting structure is component II.

The intended use comprises fastening screws for sandwich panels and connections for indoor and outdoor applications. Fastening screws for sandwich panels are made of stainless steel are intended to be used in external environments with a high or very high corrosion category.

The intended use comprises connections with predominantly static loads (e.g. wind loads, dead loads).

The provisions made in this European technical approval are based on an assumed working life of the fastening screws for sandwich panels of 25 years when installed in the works or 50 years if the screws are not accessible after installation and they are sufficient protected against corrosion (e. g. made of stainless steel). The indications given on the working life cannot be interpreted as a guarantee given by the producer, but are to be regarded only as a means for choosing the right products in relation to the expected economically reasonable working life of the works.

2 Characteristics of product and methods of verification

2.1 Characteristics of product

The fastening screws for sandwich panels shall correspond to the drawings given in the appropriate Annexes (see Table 1).

The characteristic material values, dimensions and tolerances of the fastening screws for sandwich panels neither indicated in this section nor in the Annexes shall correspond to the respective values laid down in the technical documentation⁷ to this European technical approval.

The characteristic values of the shear and tension resistance of the connections made with the fastening screws for sandwich panels as well as the maximum head displacement are given in the appropriate Annexes or in section 4.2.

The fastening screws for sandwich panels are considered to satisfy the requirements of performance class A1 of the characteristic reaction to fire.

2.2 Methods of verification

The assessment of the fitness of the fastening screws for sandwich panels for the intended use in relation to the Essential Requirements ER 1 (Mechanical resistance and stability), ER 2 (Safety in case of fire), ER 4 (Safety in use) and additional aspects of durability has been made in accordance with section 3.2 of the Common Procedural Rules for Requesting, Preparing and the Granting of European technical approvals set out in the Annex to Commission Decision 94/23/EC⁶.

The assessment of the resistance to fire performance is only relevant to the assembled system (fastening screws for sandwich panels, sandwich panels, supporting structure) which is not part of the ETA.

⁷ The technical documentation to this European technical approval is deposited at Deutsches Institut für Bautechnik and, as far as relevant for the tasks of the approved bodies involved in the attestation of conformity procedure is handed over to the approved bodies.

The fastening screws for sandwich panels are considered to satisfy the requirements of performance class A 1 of the characteristic reaction to fire, in accordance with the provisions of the EC Decision 96/603/EC (as amended) without the need for testing on the basis of its listing in that decision.

Concerning Essential Requirements No. 1 (Mechanical resistance and stability) and No. 4 (Safety in use) the following applies:

The characteristic values of resistance given in the Annexes were determined by shear and tension tests and the values for the maximum head displacement were determined by bending tests.

The formulas to calculate the design resistance are given in clause 4.2.1.

3 Evaluation and attestation of conformity and CE marking

3.1 System of attestation of conformity

According to the Decision 99/92/EC of the European Commission⁸ system 2+ of the attestation of conformity applies.

System 2+: Declaration of conformity of the product by the manufacturer on the basis of:

- (a) Tasks for the manufacturer:
 - (1) initial type-testing of the product;
 - (2) factory production control;
 - (3) testing of samples taken at the factory in accordance with a prescribed test plan.
- (b) Tasks for the approved body:
 - (4) certification of factory production control on the basis of:
 - initial inspection of factory and of factory production control;
 - continuous surveillance, assessment and approval of factory production control.

Note: Approved bodies are also referred to as "notified bodies".

3.2 Responsibilities

3.2.1 Tasks for the manufacturer

3.2.1.1 Factory production control

The manufacturer shall exercise permanent internal control of production. All the elements, requirements and provisions adopted by the manufacturer shall be documented in a systematic manner in the form of written policies and procedures, including records of results performed. This production control system shall insure that the product is in conformity with this European technical approval.

The factory production control shall be in accordance with the control plan which is part of the technical documentation of this European technical approval. The control plan is laid down in the context of the factory production control system operated by the manufacturer and deposited with Deutsches Institut für Bautechnik.⁹

The results of factory production control shall be recorded and evaluated in accordance with the provisions of the control plan.

⁸ Official Journal of the European Communities L 80 of 18.03.1998

⁹ The control plan is a confidential part of the European technical approval and only handed over to the approved bodies involved in the procedure of attestation of conformity. See section 3.2.2.

3.2.1.2 Other tasks for the manufacturer

The manufacturer shall, on the basis of a contract, involve a body which is approved for the tasks referred to in section 3.1 in the field of prefabricated structural components made of hot-rolled steel products in order to undertake the actions laid down in section 3.2.2. For this purpose, the control plan referred to in sections 3.2.1.1 and 3.2.2 shall be handed over by the manufacturer to the approved body involved.

The manufacturer shall make a declaration of conformity, stating that the construction product is in conformity with the provisions of this European technical approval.

3.2.2 Tasks for the approved bodies

The approved body shall perform the

- initial inspection of factory and of factory production control,
- continuous surveillance, assessment and approval of factory production control

in accordance with the provisions laid down in the control plan.

The approved body shall retain the essential points of its actions referred to above and state the results obtained and conclusions drawn in written reports.

The approved certification body involved by the manufacturer shall issue an EC certificate of conformity of the factory production control stating the conformity with the provisions of this European technical approval.

In cases where the provisions of the European technical approval and its control plan are no longer fulfilled the certification body shall withdraw the certificate of conformity and inform Deutsches Institut für Bautechnik without delay.

3.3 CE marking

The CE marking shall be affixed on the accompanying commercial documents. The letters "CE" shall be followed by the identification number of the approved certification body, where relevant, and be accompanied by the following additional information:

- the name and address of the producer (legal entity responsible for the manufacture),
- the last two digits of the year in which the CE marking was affixed,
- the number of the EC certificate for the factory production control,
- the number of the European technical approval,
- the name of the product.

4 Assumptions under which the fitness of the product for the intended use was favourably assessed

4.1 Manufacturing

The fastening screws for sandwich panels are manufactured in accordance with the provisions of the European technical approval using the manufacturing process as laid down in the technical documentation.

The European technical approval is issued for the product on the basis of agreed data/information, deposited with Deutsches Institut für Bautechnik, which identifies the product that has been assessed and judged. Changes to the product or production process, which could result in this deposited data/information being incorrect, should be notified to Deutsches Institut für Bautechnik before the changes are introduced. Deutsches Institut für Bautechnik will decide whether or not such changes affect the approval and consequently the validity of the CE marking on the basis of the approval and if so whether further assessment or alterations to the approval shall be necessary.

4.2 Design

4.2.1 General

Fastening screws for sandwich panels completely or partly exposed to external weather or similar conditions are made of stainless steel or are protected against corrosion. For the corrosion protection the rules given in EN 1090-2:2008 + A1:2011, EN 1993-1-3:2006 + AC:2009 and EN 1993-1-4:2006 are taken into account.

In the following and in the Annexes the structural components to be fastened are called component I and the supporting structure or base material are called component II. Furthermore the following symbols are used, see also Annex 1:

- d or D Thickness of the sandwich panel
- t_{N1} Thickness of the outer face / top plate (on the side of the screw head)
- t_{N2} Thickness of the inner face / bottom plate (on the side of the supporting structure)
- t_{II} Thickness of the supporting structure
- u from screw axes measured screw head displacement, resulting from the displacement of the outer face of the sandwich panels by thermal expansion e. g. caused by solar radiation
- max u maximum allowed screw head displacement, $u < \max u$

For calculation of shear resistance of the connection the value for the plate thickness t_{N2} (plate in contact with the supporting structure) is used as relevant. For calculation of tension resistance of the connection and pull-over the relevant thickness is plate thickness t_{N1} (plate in contact with screw head).

The loading is predominantly static. (Remark: Wind loads are regarded as predominantly static.) Dimensions, material properties, torque moments $M_{t,nom}$, minimum effective screw-in length l_{ef} , nominal material thicknesses t_{N1} and t_{N2} and maximum head displacement as stated in the ETA or in the Annexes are observed.

The verification concept stated in EN 1990:2002 + A1:2005 + A1:2005/AC:2010 is used for the design of the connections made with the fastening screws for sandwich panels. The characteristic values (shear and tension resistance) stated in the Annexes are used for the design of the entire connections.

For intermediate thicknesses of component I or component II the characteristic value for the thinner component is taken.

The following formulas are used to calculate the values of design resistance:

$$N_{R,d} = \frac{N_{R,k}}{\gamma_M}$$

$$V_{R,d} = \frac{V_{R,k}}{\gamma_M}$$

The recommended partial safety factor $\gamma_M = 1.33$ is used in order to determine the corresponding design resistances, provided no values are given in national regulations of the member state in which the fastening screws for sandwich panels are used or in the respective National Annex to Eurocode 3.

In case of combined tension and shear forces the linear interaction formula according to EN 1993-1-3:2006 + AC:2009, section 8.3 (8) is taken into account.

$$\frac{N_{S,d}}{N_{R,d}} + \frac{V_{S,d}}{V_{R,d}} \leq 1,0$$

The possibly required reduction of the tension resistance to 70% of the characteristic values of tension resistance given in the Annexes is taken into account for connections of sandwich panels to thin-walled (plate thickness $t < 5\text{mm}$) asymmetric profiles like Z – or C – shaped profiles.

4.3 Installation

The installation is only carried out according to the manufacturer's instructions. The manufacturer hands over the assembly instructions to the assembler.

It is guaranteed by the execution that no bimetallic corrosion will occur.

Screws with washers and EPDM sealing rings exposed to external weather are screwed-in with electric screw driver with appropriate set depth stop.

The use of impact wrenches is not allowed.

The fastening elements are fixed rectangular to the surface of the components to guarantee a correct load bearing and if necessary rain-proof connection.

Component I and component II are in contact to each other in the connection area. The use of compression resistant thermal insulation strips up to a thickness of 3 mm is allowed.

During installation of fastening screws admissible for timber substructures, except self-drilling screws, the components I and II which shall be connected are predrilled with $d_{pd} = 0.7 d$ (d nominal screw diameter) as long as no other instructions are given in the Annexes.

Fastening screws for steel substructures are screwed-in with the cylindrical part of the thread

- through the material if component II has a thickness up to 6 mm and
- at least 6 mm if component II has a thickness over 6 mm.

Welded drill bits or hardened tips are therefore not be taken into account.

The manufacturer's information about the maximum clamp length is considered.

Already loaded screws in regular load bearing connections are if required only replaced by thread forming screws with a larger diameter. Therefore the hole has to be predrilled for the thicker fastening screw.

The conformity of the installed fasteners with the provisions of the ETA is attested by the executing company.

5 Indications to the manufacturer

It is in the responsibility of the manufacturer to ensure that the information on the specific conditions according to 1, 2, 4.2 and 4.3 (including Annexes referred to) is given to those who are concerned. This information may be given by reproduction of the respective parts of the European technical approval.

In addition all installation data (e. g. application limits) shall be shown clearly on the package and/or on an enclosed instruction sheet, preferably using illustration(s).

Georg Feistel
Head of Department

beglaubigt:
Ulbrich

Examples of screws

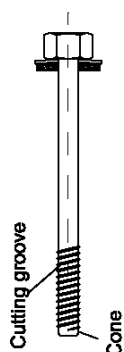

Self tapping screw with sealing washer

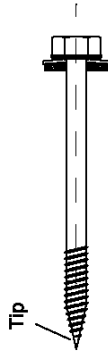

Self tapping screw with sealing washer



Self drilling screw with sealing washer

Thread under screw head is optionally

Example of execution of a connection

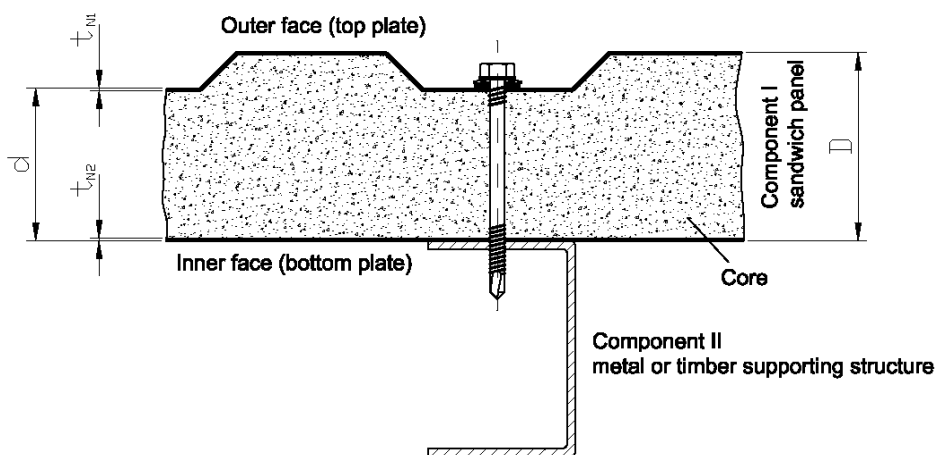

Loading conditions

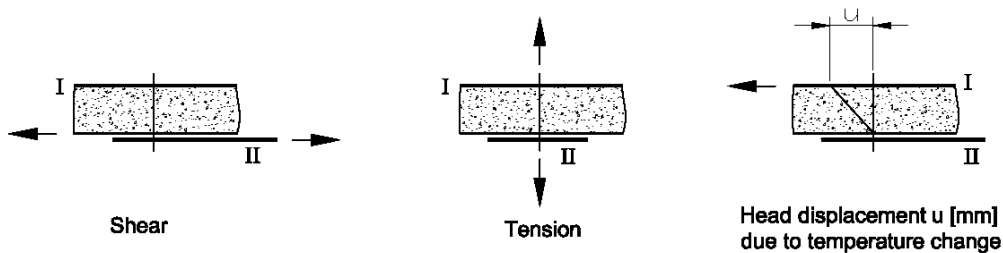

Fastening screws for sandwich panels

Example of execution of a connection
Loading conditions

Annex 1

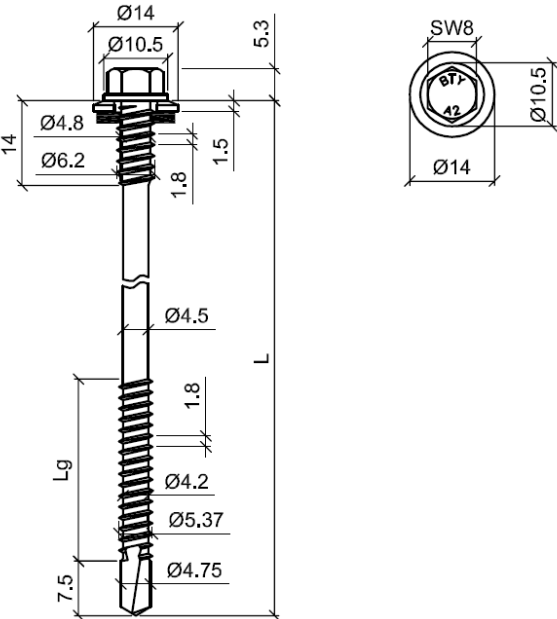

Materials
Fastener: stainless steel (1.4301) EN10088
Washer: stainless steel (1.4301) EN10088
Component I: S280GD, S320GD or S350GD - EN 10346
Component II: S235 - EN 100250-2
S280GD, S320GD or S350GD - EN 10346

Drilling capacity: $\sum (t_{N2} + t_{II}) \leq 5 \text{ mm}$ $\sum (t_{N2} + t_{II}) \leq 5 \text{ mm}$

Timber substructure
no performance determined

		Component I	Component II - steel with t_{II} [mm]				
			1,50	1,75	2,00	3,00	4,00
max. Head displacement u depending on the sandwich panel thickness D [mm]	Shear $V_{R,k}$ [kN]	0,40	0,57 ^{a)}	0,57 ^{a)}	0,57 ^{a)}	0,57 ^{a)}	0,57 ^{a)}
		0,50	0,91 ^{a)}	0,91 ^{a)}	0,91 ^{a)}	0,91 ^{a)}	0,91 ^{a)}
		0,55	1,02 ^{a)}	1,06 ^{a)}	1,10 ^{a)}	1,10 ^{a)}	1,10 ^{a)}
		0,63	1,19 ^{a)}	1,28 ^{a)}	1,38 ^{a)}	1,38 ^{a)}	1,38 ^{a)}
		0,75	1,47 ^{a)}	1,66 ^{a)}	1,84 ^{a)}	1,84 ^{a)}	1,84 ^{a)}
		0,88	1,47 ^{a)}	1,66 ^{a)}	1,84 ^{a)}	1,84 ^{a)}	1,84 ^{a)}
	Tension $N_{R,k}$ [kN]	1,00	1,47 ^{a)}	1,66 ^{a)}	1,84 ^{a)}	1,84 ^{a)}	1,84 ^{a)}
		0,40	1,22 ^{a)}	1,22 ^{a)}	1,22 ^{a)}	1,22 ^{a)}	1,22 ^{a)}
		0,50	1,60 ^{a)}	1,60 ^{a)}	1,60 ^{a)}	1,60 ^{a)}	1,60 ^{a)}
		0,55	1,79 ⁻	1,79 ^{a)}	1,79 ^{a)}	1,79 ^{a)}	1,79 ^{a)}
		0,63	1,89 ⁻	2,07 ^{a)}	2,79 ^{a)}	2,07 ^{a)}	2,07 ^{a)}
		0,75	1,89 ⁻	2,24 ⁻	2,52 ^{a)}	2,52 ^{a)}	2,52 ^{a)}
		0,88	1,89 ⁻	2,24 ⁻	2,58 ⁻	2,99 ^{a)}	2,99 ^{a)}
		1,00	1,89 ⁻	2,24 ⁻	2,58 ⁻	3,44 ^{a)}	3,44 ^{a)}
30	12	12	12	3,0	3,0		
40	15	15	15	4,6	4,6		
50	19	19	19	6,2	6,2		
60	22	22	22	7,8	7,8		
70	26	26	26	9,4	9,4		
80	30	30	30	11	11		
100	30	30	30	11	11		
120	30	30	30	11	11		
≥140	30	30	30	11	11		

If component I consists of S320GD or S350GD, allowed me to^{a)} values marked be increased by 8.3%.

Fastening screws for sandwich panels	Annex 2
BiGHTY SWPS BIM DSS 6,3/5,5 x L with hexagon head and sealing washer $\geq \text{Ø}14 \text{ mm}$	

	<p>Materials Fastener: stainless steel (1.4301) EN10088 Washer: stainless steel (1.4301) EN10088 Component I: S280GD, S320GD or S350GD - EN 10346 Component II: S235 - EN 100250-2 S280GD, S320GD or S350GD - EN 10346</p>
<p>Drilling capacity: $\sum (t_{N2} + t_{II}) \leq 5 \text{ mm}$</p>	
<p>Timber substructure no performance determined</p>	

		Component I	Component II - steel with t_{II} [mm]				
			1,50	1,75	2,00	3,00	4,00
max. Head displacement u depending on the sandwich panel thickness D [mm]	Shear $V_{R,k}$ [kN]	0,40	0,57 ^{a)}	0,57 ^{a)}	0,57 ^{a)}	0,57 ^{a)}	0,57 ^{a)}
		0,50	0,91 ^{a)}	0,91 ^{a)}	0,91 ^{a)}	0,91 ^{a)}	0,91 ^{a)}
		0,55	1,02 ^{a)}	1,06 ^{a)}	1,10 ^{a)}	1,10 ^{a)}	1,10 ^{a)}
		0,63	1,19 ^{a)}	1,28 ^{a)}	1,38 ^{a)}	1,38 ^{a)}	1,38 ^{a)}
		0,75	1,47 ^{a)}	1,66 ^{a)}	1,84 ^{a)}	1,84 ^{a)}	1,84 ^{a)}
		0,88	1,47 ^{a)}	1,66 ^{a)}	1,84 ^{a)}	1,84 ^{a)}	1,84 ^{a)}
	Tension $N_{R,k}$ [kN]	1,00	1,47 ^{a)}	1,66 ^{a)}	1,84 ^{a)}	1,84 ^{a)}	1,84 ^{a)}
		0,40	1,39 ^{a)}	1,39 ^{a)}	1,39 ^{a)}	1,39 ^{a)}	1,39 ^{a)}
		0,50	1,84 ⁻	1,84 ^{a)}	1,84 ^{a)}	1,84 ^{a)}	1,84 ^{a)}
		0,55	1,89 ⁻	2,14 ⁻	2,14 ^{a)}	2,14 ^{a)}	2,14 ^{a)}
		0,63	1,89 ⁻	2,24 ⁻	2,58 ⁻	2,58 ^{a)}	2,58 ^{a)}
		0,75	1,89 ⁻	2,24 ⁻	2,58 ⁻	3,32 ^{a)}	3,32 ^{a)}
		0,88	1,89 ⁻	2,24 ⁻	2,58 ⁻	3,67 ^{a)}	3,67 ^{a)}
		1,00	1,89 ⁻	2,24 ⁻	2,58 ⁻	4,01 ^{a)}	4,01 ^{a)}
30	12	12	12	3,0	3,0		
40	15	15	15	4,6	4,6		
50	19	19	19	6,2	6,2		
60	22	22	22	7,8	7,8		
70	26	26	26	9,4	9,4		
80	30	30	30	11	11		
100	30	30	30	11	11		
120	30	30	30	11	11		
≥140	30	30	30	11	11		

If component I consists of S320GD or S350GD, allowed me to^{a)} values marked be increased by 8.3%.

<p>Fastening screws for sandwich panels</p>	<p>Annex 3</p>
<p>BiGHTY SWPS BIM DSS 6,3/5,5 x L with hexagon head and sealing washer $\geq \text{Ø}16 \text{ mm}$</p>	

English translation prepared by DIBt

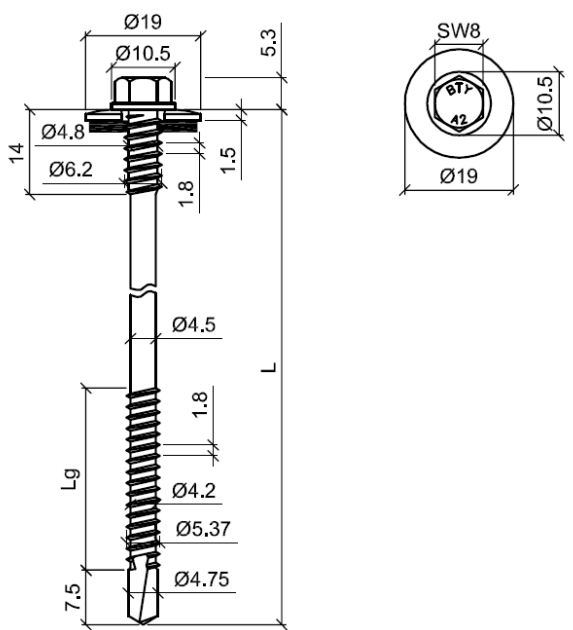

Materials
Fastener: stainless steel (1.4301) EN10088
Washer: stainless steel (1.4301) EN10088
Component I: S280GD, S320GD or S350GD - EN 10346
Component II: S235 - EN 100250-2
S280GD, S320GD or S350GD - EN 10346

Drilling capacity: $\sum (t_{N2} + t_{II}) \leq 5 \text{ mm}$

Timber substructure
no performance determined

		Component I	Component II - steel with t_{II} [mm]				
			1,50	1,75	2,00	3,00	4,00
max. Head displacement u depending on the sandwich panel thickness D [mm]	Shear $V_{R,k}$ [kN]	0,40	0,57 ^{a)}	0,57 ^{a)}	0,57 ^{a)}	0,57 ^{a)}	0,57 ^{a)}
		0,50	0,91 ^{a)}	0,91 ^{a)}	0,91 ^{a)}	0,91 ^{a)}	0,91 ^{a)}
		0,55	1,02 ^{a)}	1,06 ^{a)}	1,10 ^{a)}	1,10 ^{a)}	1,10 ^{a)}
		0,63	1,19 ^{a)}	1,28 ^{a)}	1,38 ^{a)}	1,38 ^{a)}	1,38 ^{a)}
		0,75	1,47 ^{a)}	1,66 ^{a)}	1,84 ^{a)}	1,84 ^{a)}	1,84 ^{a)}
		0,88	1,47 ^{a)}	1,66 ^{a)}	1,84 ^{a)}	1,84 ^{a)}	1,84 ^{a)}
	Tension $N_{R,k}$ [kN]	1,00	1,47 ^{a)}	1,66 ^{a)}	1,84 ^{a)}	1,84 ^{a)}	1,84 ^{a)}
		0,40	1,66 ^{a)}	1,66 ^{a)}	1,66 ^{a)}	1,66 ^{a)}	1,66 ^{a)}
		0,50	1,89 ⁻	2,17 ⁻	2,17 ^{a)}	2,17 ^{a)}	2,17 ^{a)}
		0,55	1,89 ⁻	2,42 ⁻	2,43 ⁻	2,43 ^{a)}	2,43 ^{a)}
		0,63	1,89 ⁻	2,24 ⁻	2,58 ⁻	2,18 ^{a)}	2,18 ^{a)}
		0,75	1,89 ⁻	2,24 ⁻	2,58 ⁻	3,42 ^{a)}	3,42 ^{a)}
		0,88	1,89 ⁻	2,24 ⁻	2,58 ⁻	4,06 ^{a)}	4,06 ^{a)}
		1,00	1,89 ⁻	2,24 ⁻	2,58 ⁻	4,76 ⁻	4,76 ^{a)}
30	12	12	12	3,0	3,0		
40	15	15	15	4,6	4,6		
50	19	19	19	6,2	6,2		
60	22	22	22	7,8	7,8		
70	26	26	26	9,4	9,4		
80	30	30	30	11	11		
100	30	30	30	11	11		
120	30	30	30	11	11		
≥140	30	30	30	11	11		

If component I consists of S320GD or S350GD, allowed me to ^{a)} values marked be increased by 8.3%.

Fastening screws for sandwich panels	Annex 4
BiGHTY SWPS BIM DSS 6,3/5,5 x L with hexagon head and sealing washer $\geq \text{Ø}19 \text{ mm}$	

	<p>Materials Fastener: carbon steel case hardened and galvanized Washer: carbon steel stainless steel (1.4301) EN10088 Component I: S280GD, S320GD or S350GD - EN 10346 Component II: S235 - EN 100250-2 S280GD, S320GD or S350GD - EN 10346</p>
<p>Drilling capacity: $\sum (t_{N2} + t_{ID}) \leq 5 \text{ mm}$</p>	
<p><u>Timber substructure</u> no performance determined</p>	

		Component I	Component II - steel with t_{II} [mm]				
			1,50	1,75	2,00	3,00	4,00
Plate thickness t_{N1} or t_{N2} [mm]	Shear $V_{R,k}$ [kN]	0,40	0,57 ^{a)}	0,57 ^{a)}	0,57 ^{a)}	0,57 ^{a)}	0,57 ^{a)}
		0,50	0,91 ^{a)}	0,91 ^{a)}	0,91 ^{a)}	0,91 ^{a)}	0,91 ^{a)}
		0,55	1,02 ^{a)}	1,06 ^{a)}	1,10 ^{a)}	1,10 ^{a)}	1,10 ^{a)}
		0,63	1,19 ^{a)}	1,28 ^{a)}	1,38 ^{a)}	1,38 ^{a)}	1,38 ^{a)}
		0,75	1,47 ^{a)}	1,66 ^{a)}	1,84 ^{a)}	1,84 ^{a)}	1,84 ^{a)}
		0,88	1,47 ^{a)}	1,66 ^{a)}	1,84 ^{a)}	1,84 ^{a)}	1,84 ^{a)}
	Tension $N_{R,k}$ [kN]	0,40	1,22 ^{a)}	1,22 ^{a)}	1,22 ^{a)}	1,22 ^{a)}	1,22 ^{a)}
		0,50	1,60 ^{a)}	1,60 ^{a)}	1,60 ^{a)}	1,60 ^{a)}	1,60 ^{a)}
		0,55	1,79 ⁻	1,79 ^{a)}	1,79 ^{a)}	1,79 ^{a)}	1,79 ^{a)}
		0,63	1,89 ⁻	2,07 ^{a)}	2,79 ^{a)}	2,07 ^{a)}	2,07 ^{a)}
		0,75	1,89 ⁻	2,24 ⁻	2,52 ^{a)}	2,52 ^{a)}	2,52 ^{a)}
		0,88	1,89 ⁻	2,24 ⁻	2,58 ⁻	2,99 ^{a)}	2,99 ^{a)}
max. Head displacement u depending on the sandwich panel thickness D [mm]	30		12	12	12	2,5	2,5
	40		15	15	15	3,0	3,0
	50		19	19	19	3,5	3,5
	60		22	22	22	4,0	4,0
	70		26	26	26	4,5	4,5
	80		30	30	30	5,0	5,0
	100		30	30	30	5,0	5,0
	120		30	30	30	5,0	5,0
≥140		30	30	30	5,0	5,0	

If component I consists of S320GD or S350GD, allowed me to ^{a)} values marked be increased by 8.3%.

<p>Fastening screws for sandwich panels</p>	<p>Annex 5</p>
<p>BiGHTY SWPS DSS 6,3/5 x L with hexagon head and sealing washer $\geq \text{Ø}14 \text{ mm}$</p>	

	<p>Materials Fastener: carbon steel case hardened and galvanized Washer: carbon steel stainless steel (1.4301) EN10088 Component I: S280GD, S320GD or S350GD - EN 10346 Component II: S235 - EN 100250-2 S280GD, S320GD or S350GD - EN 10346</p> <p>Drilling capacity: $\sum (t_{N2} + t_{II}) \leq 5 \text{ mm}$</p> <p>Timber substructure no performance determined</p>
--	---

Component I		Component II - steel with t_{II} [mm]					
		1,50	1,75	2,00	3,00	4,00	
Plate thickness t_{N1} or t_{N2} [mm]	Shear $V_{R,k}$ [kN]	0,40	0,57 ^{a)}	0,57 ^{a)}	0,57 ^{a)}	0,57 ^{a)}	0,57 ^{a)}
		0,50	0,91 ^{a)}	0,91 ^{a)}	0,91 ^{a)}	0,91 ^{a)}	0,91 ^{a)}
		0,55	1,02 ^{a)}	1,06 ^{a)}	1,10 ^{a)}	1,10 ^{a)}	1,10 ^{a)}
		0,63	1,19 ^{a)}	1,28 ^{a)}	1,38 ^{a)}	1,38 ^{a)}	1,38 ^{a)}
		0,75	1,47 ^{a)}	1,66 ^{a)}	1,84 ^{a)}	1,84 ^{a)}	1,84 ^{a)}
		0,88	1,47 ^{a)}	1,66 ^{a)}	1,84 ^{a)}	1,84 ^{a)}	1,84 ^{a)}
		1,00	1,47 ^{a)}	1,66 ^{a)}	1,84 ^{a)}	1,84 ^{a)}	1,84 ^{a)}
	Tension $N_{R,k}$ [kN]	0,40	1,39 ^{a)}	1,39 ^{a)}	1,39 ^{a)}	1,39 ^{a)}	1,39 ^{a)}
		0,50	1,84 ⁻	1,84 ^{a)}	1,84 ^{a)}	1,84 ^{a)}	1,84 ^{a)}
		0,55	1,89 ⁻	2,14 ⁻	2,14 ^{a)}	2,14 ^{a)}	2,14 ^{a)}
		0,63	1,89 ⁻	2,24 ⁻	2,58 ⁻	2,58 ^{a)}	2,58 ^{a)}
		0,75	1,89 ⁻	2,24 ⁻	2,58 ⁻	3,32 ^{a)}	3,32 ^{a)}
		0,88	1,89 ⁻	2,24 ⁻	2,58 ⁻	3,67 ^{a)}	3,67 ^{a)}
		1,00	1,89 ⁻	2,24 ⁻	2,58 ⁻	4,01 ^{a)}	4,01 ^{a)}
max. Head displacement u depending on the sandwich panel thickness D [mm]	30	12	12	12	2,5	2,5	
	40	15	15	15	3,0	3,0	
	50	19	19	19	3,5	3,5	
	60	22	22	22	4,0	4,0	
	70	26	26	26	4,5	4,5	
	80	30	30	30	5,0	5,0	
	100	30	30	30	5,0	5,0	
	120	30	30	30	5,0	5,0	
≥140	30	30	30	5,0	5,0		

If component I consists of S320GD or S350GD, allowed me to ^{a)} values marked be increased by 8.3%.

<p>Fastening screws for sandwich panels</p>	<p>Annex 6</p>
<p>BiGHTY SWPS DSS 6,3/5,5 x L with hexagon head and sealing washer $\geq \text{Ø}16 \text{ mm}$</p>	

English translation prepared by DIBt

	<p>Materials Fastener: carbon steel case hardened and galvanized Washer: carbon steel stainless steel (1.4301) EN10088 Component I: S280GD, S320GD or S350GD - EN 10346 Component II: S235 - EN 100250-2 S280GD, S320GD or S350GD - EN 10346</p>
<p>Drilling capacity: $\sum (t_{N2} + t_{II}) \leq 5 \text{ mm}$</p>	
<p>Timber substructure no performance determined</p>	

		Component I	Component II - steel with t_{II} [mm]				
			1,50	1,75	2,00	3,00	4,00
max. Head displacement u depending on the sandwich panel thickness D [mm]	Shear $V_{R,k}$ [kN]	0,40	0,57 ^{a)}	0,57 ^{a)}	0,57 ^{a)}	0,57 ^{a)}	0,57 ^{a)}
		0,50	0,91 ^{a)}	0,91 ^{a)}	0,91 ^{a)}	0,91 ^{a)}	0,91 ^{a)}
		0,55	1,02 ^{a)}	1,06 ^{a)}	1,10 ^{a)}	1,10 ^{a)}	1,10 ^{a)}
		0,63	1,19 ^{a)}	1,28 ^{a)}	1,38 ^{a)}	1,38 ^{a)}	1,38 ^{a)}
		0,75	1,47 ^{a)}	1,66 ^{a)}	1,84 ^{a)}	1,84 ^{a)}	1,84 ^{a)}
		0,88	1,47 ^{a)}	1,66 ^{a)}	1,84 ^{a)}	1,84 ^{a)}	1,84 ^{a)}
	Tension $N_{R,k}$ [kN]	1,00	1,47 ^{a)}	1,66 ^{a)}	1,84 ^{a)}	1,84 ^{a)}	1,84 ^{a)}
		0,40	1,66 ^{a)}	1,66 ^{a)}	1,66 ^{a)}	1,66 ^{a)}	1,66 ^{a)}
		0,50	1,89 -	2,17 -	2,17 ^{a)}	2,17 ^{a)}	2,17 ^{a)}
		0,55	1,89 -	2,42 -	2,43 -	2,43 ^{a)}	2,43 ^{a)}
		0,63	1,89 -	2,24 -	2,58 -	2,18 ^{a)}	2,18 ^{a)}
		0,75	1,89 -	2,24 -	2,58 -	3,42 ^{a)}	3,42 ^{a)}
		0,88	1,89 -	2,24 -	2,58 -	4,06 ^{a)}	4,06 ^{a)}
		1,00	1,89 -	2,24 -	2,58 -	4,76 -	4,76 ^{a)}
	30	12	12	12	2,5	2,5	
	40	15	15	15	3,0	3,0	
	50	19	19	19	3,5	3,5	
	60	22	22	22	4,0	4,0	
	70	26	26	26	4,5	4,5	
	80	30	30	30	5,0	5,0	
	100	30	30	30	5,0	5,0	
	120	30	30	30	5,0	5,0	
≥140	30	30	30	5,0	5,0		

If component I consists of S320GD or S350GD, allowed me to^{a)} values marked be increased by 8.3%.

<p>Fastening screws for sandwich panels</p>	<p>Annex 7</p>
<p>BiGHTY SWPS DSS 6,3/5,5 x L with hexagon head and sealing washer $\geq \text{Ø}19 \text{ mm}$</p>	

English translation prepared by DIBt

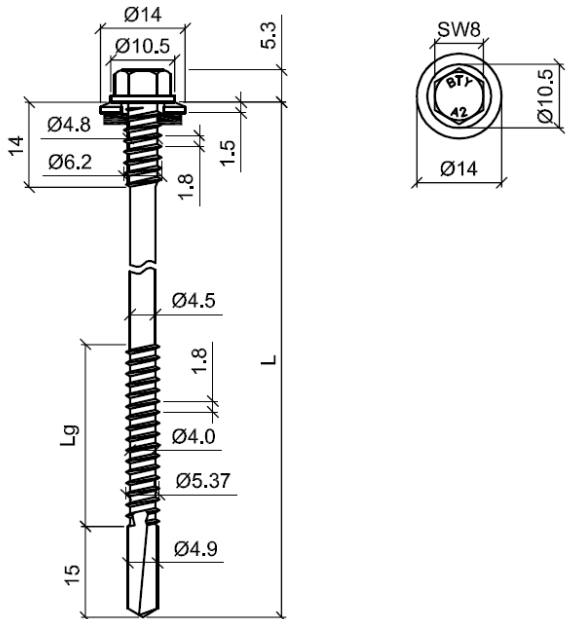

Materials
Fastener: stainless steel (1.4301) EN10088
Washer: stainless steel (1.4301) EN10088
Component I: S280GD, S320GD or S350GD - EN 10346
Component II: S235 - EN 100250-2
S280GD, S320GD or S350GD - EN 10346

Drilling capacity: $\sum (t_{N2} + t_{II}) \leq 12 \text{ mm}$

Timber substructure
no performance determined

Component I		Component II - steel with t_{II} [mm]					
		4,00	5,00	6,00	8,00	10,00	
Plate thickness t_{N1} or t_{N2} [mm]	Shear $V_{R,k}$ [kN]	0,40	0,67 ^{a)}	0,67 ^{a)}	0,67 ^{a)}	0,67 ^{a)}	0,67 ^{a)}
		0,50	1,03 ^{a)}	1,03 ^{a)}	1,03 ^{a)}	1,03 ^{a)}	1,03 ^{a)}
		0,55	1,14 ^{a)}	1,14 ^{a)}	1,14 ^{a)}	1,14 ^{a)}	1,14 ^{a)}
		0,63	1,32 ^{a)}	1,32 ^{a)}	1,32 ^{a)}	1,32 ^{a)}	1,32 ^{a)}
		0,75	1,60 ^{a)}	1,60 ^{a)}	1,60 ^{a)}	1,60 ^{a)}	1,60 ^{a)}
		0,88	1,60 ^{a)}	1,60 ^{a)}	1,60 ^{a)}	1,60 ^{a)}	1,60 ^{a)}
		1,00	1,60 ^{a)}	1,60 ^{a)}	1,60 ^{a)}	1,60 ^{a)}	1,60 ^{a)}
	Tension $N_{R,k}$ [kN]	0,40	1,22 ^{a)}	1,22 ^{a)}	1,22 ^{a)}	1,22 ^{a)}	1,22 ^{a)}
		0,50	1,60 ^{a)}	1,60 ^{a)}	1,60 ^{a)}	1,60 ^{a)}	1,60 ^{a)}
		0,55	1,79 ^{a)}	1,79 ^{a)}	1,79 ^{a)}	1,79 ^{a)}	1,79 ^{a)}
		0,63	2,07 ^{a)}	2,07 ^{a)}	2,07 ^{a)}	2,07 ^{a)}	2,07 ^{a)}
		0,75	2,52 ^{a)}	2,52 ^{a)}	2,52 ^{a)}	2,52 ^{a)}	2,52 ^{a)}
		0,88	2,99 ^{a)}	2,99 ^{a)}	2,99 ^{a)}	2,99 ^{a)}	2,99 ^{a)}
		1,00	3,44 ^{a)}	3,44 ^{a)}	3,44 ^{a)}	3,44 ^{a)}	3,44 ^{a)}
max. Head displacement u depending on the sandwich panel thickness D [mm]	30	1,5	1,5	1,5	1,5	1,5	
	40	3,2	3,2	3,2	3,2	3,2	
	50	4,9	4,9	4,9	4,9	4,9	
	60	6,6	6,6	6,6	6,6	6,6	
	70	8,3	8,3	8,3	8,3	8,3	
	80	10	10	10	10	10	
	100	10	10	10	10	10	
	120	10	10	10	10	10	
≥140	10	10	10	10	10		

If component I consists of S320GD or S350GD, allowed me to ^{a)} values marked be increased by 8.3%.

Fastening screws for sandwich panels	Annex 8
BiGHTY SWPS BIM DSS 6,3/5,5 x L with hexagon head and sealing washer $\geq \text{Ø}14 \text{ mm}$	

English translation prepared by DIBt

	<p>Materials Fastener: stainless steel (1.4301) EN10088 Washer: stainless steel (1.4301) EN10088 Component I: S280GD, S320GD or S350GD - EN 10346 Component II: S235 - EN 100250-2 S280GD, S320GD or S350GD - EN 10346</p>
<p>Drilling capacity: $\sum (t_{N2} + t_{D}) \leq 12 \text{ mm}$</p>	
<p><u>Timber substructure</u> no performance determined</p>	

Component I		Component II - steel with t_{II} [mm]					
		4,00	5,00	6,00	8,00	10,00	
Plate thickness t_{N1} or t_{N2} [mm]	Shear $V_{R,k}$ [kN]	0,40	0,67 ^{a)}	0,67 ^{a)}	0,67 ^{a)}	0,67 ^{a)}	0,67 ^{a)}
		0,50	1,03 ^{a)}	1,03 ^{a)}	1,03 ^{a)}	1,03 ^{a)}	1,03 ^{a)}
		0,55	1,14 ^{a)}	1,14 ^{a)}	1,14 ^{a)}	1,14 ^{a)}	1,14 ^{a)}
		0,63	1,32 ^{a)}	1,32 ^{a)}	1,32 ^{a)}	1,32 ^{a)}	1,32 ^{a)}
		0,75	1,60 ^{a)}	1,60 ^{a)}	1,60 ^{a)}	1,60 ^{a)}	1,60 ^{a)}
		0,88	1,60 ^{a)}	1,60 ^{a)}	1,60 ^{a)}	1,60 ^{a)}	1,60 ^{a)}
	Tension $N_{R,k}$ [kN]	0,40	1,39 ^{a)}	1,39 ^{a)}	1,39 ^{a)}	1,39 ^{a)}	1,39 ^{a)}
		0,50	1,84 ^{a)}	1,84 ^{a)}	1,84 ^{a)}	1,84 ^{a)}	1,84 ^{a)}
		0,55	2,14 ^{a)}	2,14 ^{a)}	2,14 ^{a)}	2,14 ^{a)}	2,14 ^{a)}
		0,63	2,58 ^{a)}	2,58 ^{a)}	2,58 ^{a)}	2,58 ^{a)}	2,58 ^{a)}
		0,75	3,32 ^{a)}	3,32 ^{a)}	3,32 ^{a)}	3,32 ^{a)}	3,32 ^{a)}
		0,88	3,67 ^{a)}	3,67 ^{a)}	3,67 ^{a)}	3,67 ^{a)}	3,67 ^{a)}
max. Head displacement u depending on the sandwich panel thickness D [mm]	1,00	4,01 ^{a)}	4,01 ^{a)}	4,01 ^{a)}	4,01 ^{a)}	4,01 ^{a)}	
	30	1,5	1,5	1,5	1,5	1,5	
	40	3,2	3,2	3,2	3,2	3,2	
	50	4,9	4,9	4,9	4,9	4,9	
	60	6,6	6,6	6,6	6,6	6,6	
	70	8,3	8,3	8,3	8,3	8,3	
	80	10	10	10	10	10	
	100	10	10	10	10	10	
120	10	10	10	10	10		
≥140	10	10	10	10	10		

If component I consists of S320GD or S350GD, allowed me to ^{a)} values marked be increased by 8.3%.

<p>Fastening screws for sandwich panels</p>	<p>Annex 9</p>
<p>BIGHTY SWPS BIM DSS 6,3/5,5 x L with hexagon head and sealing washer $\geq \text{Ø}16 \text{ mm}$</p>	

	<p>Materials Fastener: stainless steel (1.4301) EN10088 Washer: stainless steel (1.4301) EN10088 Component I: S280GD, S320GD or S350GD - EN 10346 Component II: S235 - EN 100250-2 S280GD, S320GD or S350GD - EN 10346</p>
<p>Drilling capacity: $\sum (t_{N2} + t_{II}) \leq 12 \text{ mm}$</p>	
<p>Timber substructure no performance determined</p>	

		Component I	Component II - steel with t_{II} [mm]				
			4,00	5,00	6,00	8,00	10,00
Plate thickness t_{N1} or t_{N2} [mm]	Shear $V_{R,k}$ [kN]	0,40	0,67 ^{a)}	0,67 ^{a)}	0,67 ^{a)}	0,67 ^{a)}	0,67 ^{a)}
		0,50	1,03 ^{a)}	1,03 ^{a)}	1,03 ^{a)}	1,03 ^{a)}	1,03 ^{a)}
		0,55	1,14 ^{a)}	1,14 ^{a)}	1,14 ^{a)}	1,14 ^{a)}	1,14 ^{a)}
		0,63	1,32 ^{a)}	1,32 ^{a)}	1,32 ^{a)}	1,32 ^{a)}	1,32 ^{a)}
		0,75	1,60 ^{a)}	1,60 ^{a)}	1,60 ^{a)}	1,60 ^{a)}	1,60 ^{a)}
		0,88	1,60 ^{a)}	1,60 ^{a)}	1,60 ^{a)}	1,60 ^{a)}	1,60 ^{a)}
	Tension $N_{R,k}$ [kN]	0,40	1,66 ^{a)}	1,66 ^{a)}	1,66 ^{a)}	1,66 ^{a)}	1,66 ^{a)}
		0,50	2,17 ^{a)}	2,17 ^{a)}	2,17 ^{a)}	2,17 ^{a)}	2,17 ^{a)}
		0,55	2,43 ^{a)}	2,43 ^{a)}	2,43 ^{a)}	2,43 ^{a)}	2,43 ^{a)}
		0,63	2,81 ^{a)}	2,81 ^{a)}	2,81 ^{a)}	2,81 ^{a)}	2,81 ^{a)}
		0,75	3,42 ^{a)}	3,42 ^{a)}	3,42 ^{a)}	3,42 ^{a)}	3,42 ^{a)}
		0,88	4,06 ^{a)}	4,06 ^{a)}	4,06 ^{a)}	4,06 ^{a)}	4,06 ^{a)}
max. Head displacement u depending on the sandwich panel thickness D [mm]	30	1,5	1,5	1,5	1,5	1,5	
	40	3,2	3,2	3,2	3,2	3,2	
	50	4,9	4,9	4,9	4,9	4,9	
	60	6,6	6,6	6,6	6,6	6,6	
	70	8,3	8,3	8,3	8,3	8,3	
	80	10	10	10	10	10	
	100	10	10	10	10	10	
	120	10	10	10	10	10	
≥140	10	10	10	10	10		

If component I consists of S320GD or S350GD, allowed me to ^{a)} values marked be increased by 8.3%.

<p>Fastening screws for sandwich panels</p>	<p>Annex 10</p>
<p>BIGHTY SWPS BIM DSS 6,3/5,5 x L with hexagon head and sealing washer $\geq \text{Ø}19 \text{ mm}$</p>	

	<p>Materials Fastener: carbon steel case hardened and galvanized Washer: carbon steel stainless steel (1.4301) EN10088 Component I: S280GD, S320GD or S350GD - EN 10346 Component II: S235 - EN 100250-2 S280GD, S320GD or S350GD - EN 10346</p>
<p>Drilling capacity $\Sigma(t_{N2} + t_{II}) \leq 12 \text{ mm}$</p>	
<p>Timber substructure no performance determined</p>	

		Component I	Component II - steel with t_{II} [mm]				
			4,00	5,00	6,00	8,00	10,00
max. Head displacement u depending on the sandwich panel thickness D [mm]	Shear $V_{R,k}$ [kN]	0,40	0,67 ^{a)}	0,67 ^{a)}	0,67 ^{a)}	0,67 ^{a)}	0,67 ^{a)}
		0,50	1,03 ^{a)}	1,03 ^{a)}	1,03 ^{a)}	1,03 ^{a)}	1,03 ^{a)}
		0,55	1,14 ^{a)}	1,14 ^{a)}	1,14 ^{a)}	1,14 ^{a)}	1,14 ^{a)}
		0,63	1,32 ^{a)}	1,32 ^{a)}	1,32 ^{a)}	1,32 ^{a)}	1,32 ^{a)}
		0,75	1,60 ^{a)}	1,60 ^{a)}	1,60 ^{a)}	1,60 ^{a)}	1,60 ^{a)}
		0,88	1,60 ^{a)}	1,60 ^{a)}	1,60 ^{a)}	1,60 ^{a)}	1,60 ^{a)}
		1,00	1,60 ^{a)}	1,60 ^{a)}	1,60 ^{a)}	1,60 ^{a)}	1,60 ^{a)}
	Tension $N_{R,k}$ [kN]	0,40	1,22 ^{a)}	1,22 ^{a)}	1,22 ^{a)}	1,22 ^{a)}	1,22 ^{a)}
		0,50	1,60 ^{a)}	1,60 ^{a)}	1,60 ^{a)}	1,60 ^{a)}	1,60 ^{a)}
		0,55	1,79 ^{a)}	1,79 ^{a)}	1,79 ^{a)}	1,79 ^{a)}	1,79 ^{a)}
		0,63	2,07 ^{a)}	2,07 ^{a)}	2,07 ^{a)}	2,07 ^{a)}	2,07 ^{a)}
		0,75	2,52 ^{a)}	2,52 ^{a)}	2,52 ^{a)}	2,52 ^{a)}	2,52 ^{a)}
		0,88	2,99 ^{a)}	2,99 ^{a)}	2,99 ^{a)}	2,99 ^{a)}	2,99 ^{a)}
		1,00	3,44 ^{a)}	3,44 ^{a)}	3,44 ^{a)}	3,44 ^{a)}	3,44 ^{a)}
		30	1,0	1,0	1,0	1,0	1,0
		40	2,0	2,0	2,0	2,0	2,0
		50	3,0	3,0	3,0	3,0	3,0
		60	4,0	4,0	4,0	4,0	4,0
		70	5,0	5,0	5,0	5,0	5,0
		80	6,0	6,0	6,0	6,0	6,0
		100	6,0	6,0	6,0	6,0	6,0
		120	6,0	6,0	6,0	6,0	6,0
		≥140	6,0	6,0	6,0	6,0	6,0

If component I consists of S320GD or S350GD, allowed m_e to ^{a)} values marked be increased by 8.3%.

<p>Fastening screws for sandwich panels</p>	<p>Annex 11</p>
<p>BiGHTY SWPS DSS 6,3/5,5 x L with hexagon head and sealing washer $\geq \text{Ø}14 \text{ mm}$</p>	

	<p>Materials Fastener: carbon steel case hardened and galvanized Washer: carbon steel stainless steel (1.4301) EN10088 Component I: S280GD, S320GD or S350GD - EN 10346 Component II: S235 - EN 100250-2 S280GD, S320GD or S350GD - EN 10346</p> <p>Drilling capacity: $\sum (t_{N2} + t_{II}) \leq 12 \text{ mm}$</p> <p>Timber substructure no performance determined</p>
--	---

		Component I	Component II - steel with t_{II} [mm]				
			4,00	5,00	6,00	8,00	10,00
Plate thickness t_{N1} or t_{N2} [mm]	Shear $V_{R,k}$ [kN]	0,40	0,67 ^{a)}	0,67 ^{a)}	0,67 ^{a)}	0,67 ^{a)}	0,67 ^{a)}
		0,50	1,03 ^{a)}	1,03 ^{a)}	1,03 ^{a)}	1,03 ^{a)}	1,03 ^{a)}
		0,55	1,14 ^{a)}	1,14 ^{a)}	1,14 ^{a)}	1,14 ^{a)}	1,14 ^{a)}
		0,63	1,32 ^{a)}	1,32 ^{a)}	1,32 ^{a)}	1,32 ^{a)}	1,32 ^{a)}
		0,75	1,60 ^{a)}	1,60 ^{a)}	1,60 ^{a)}	1,60 ^{a)}	1,60 ^{a)}
		0,88	1,60 ^{a)}	1,60 ^{a)}	1,60 ^{a)}	1,60 ^{a)}	1,60 ^{a)}
	Tension $N_{R,k}$ [kN]	1,00	1,60 ^{a)}	1,60 ^{a)}	1,60 ^{a)}	1,60 ^{a)}	1,60 ^{a)}
		0,40	1,39 ^{a)}	1,39 ^{a)}	1,39 ^{a)}	1,39 ^{a)}	1,39 ^{a)}
		0,50	1,84 ^{a)}	1,84 ^{a)}	1,84 ^{a)}	1,84 ^{a)}	1,84 ^{a)}
		0,55	2,14 ^{a)}	2,14 ^{a)}	2,14 ^{a)}	2,14 ^{a)}	2,14 ^{a)}
		0,63	2,58 ^{a)}	2,58 ^{a)}	2,58 ^{a)}	2,58 ^{a)}	2,58 ^{a)}
		0,75	3,32 ^{a)}	3,32 ^{a)}	3,32 ^{a)}	3,32 ^{a)}	3,32 ^{a)}
	max. Head displacement u depending on the sandwich panel thickness D [mm]	0,88	3,67 ^{a)}	3,67 ^{a)}	3,67 ^{a)}	3,67 ^{a)}	3,67 ^{a)}
		1,00	4,01 ^{a)}	4,01 ^{a)}	4,01 ^{a)}	4,01 ^{a)}	4,01 ^{a)}
30		1,0	1,0	1,0	1,0	1,0	
40		2,0	2,0	2,0	2,0	2,0	
50		3,0	3,0	3,0	3,0	3,0	
60		4,0	4,0	4,0	4,0	4,0	
70		5,0	5,0	5,0	5,0	5,0	
80		6,0	6,0	6,0	6,0	6,0	
100	6,0	6,0	6,0	6,0	6,0		
120	6,0	6,0	6,0	6,0	6,0		
≥140	6,0	6,0	6,0	6,0	6,0		

If component I consists of S320GD or S350GD, allowed me to^{a)} values marked be increased by 8.3%.

<p>Fastening screws for sandwich panels</p> <p>BiGHTY SWPS DSS 6,3/5,5 x L with hexagon head and sealing washer $\geq \text{Ø}16 \text{ mm}$</p>	<p>Annex 12</p>
---	-----------------

	<p>Materials Fastener: carbon steel case hardened and galvanized Washer: carbon steel stainless steel (1.4301) EN10088 Component I: S280GD, S320GD or S350GD - EN 10346 Component II: S235 - EN 100250-2 S280GD, S320GD or S350GD - EN 10346</p> <p>Drilling capacity: $\Sigma (t_{N2} + t_{II}) \leq 12 \text{ mm}$</p> <p><u>Timber substructure</u> no performance determined</p>
--	--

		Component I	Component II - steel with t_{II} [mm]				
			4,00	5,00	6,00	8,00	10,00
Plate thickness t_{N1} or t_{N2} [mm]	Shear $V_{R,k}$ [kN]	0,40	0,67 ^{a)}	0,67 ^{a)}	0,67 ^{a)}	0,67 ^{a)}	0,67 ^{a)}
		0,50	1,03 ^{a)}	1,03 ^{a)}	1,03 ^{a)}	1,03 ^{a)}	1,03 ^{a)}
		0,55	1,14 ^{a)}	1,14 ^{a)}	1,14 ^{a)}	1,14 ^{a)}	1,14 ^{a)}
		0,63	1,32 ^{a)}	1,32 ^{a)}	1,32 ^{a)}	1,32 ^{a)}	1,32 ^{a)}
		0,75	1,60 ^{a)}	1,60 ^{a)}	1,60 ^{a)}	1,60 ^{a)}	1,60 ^{a)}
		0,88	1,60 ^{a)}	1,60 ^{a)}	1,60 ^{a)}	1,60 ^{a)}	1,60 ^{a)}
		1,00	1,60 ^{a)}	1,60 ^{a)}	1,60 ^{a)}	1,60 ^{a)}	1,60 ^{a)}
	Tension $N_{R,k}$ [kN]	0,40	1,66 ^{a)}	1,66 ^{a)}	1,66 ^{a)}	1,66 ^{a)}	1,66 ^{a)}
		0,50	2,17 ^{a)}	2,17 ^{a)}	2,17 ^{a)}	2,17 ^{a)}	2,17 ^{a)}
		0,55	2,43 ^{a)}	2,43 ^{a)}	2,43 ^{a)}	2,43 ^{a)}	2,43 ^{a)}
		0,63	2,81 ^{a)}	2,81 ^{a)}	2,81 ^{a)}	2,81 ^{a)}	2,81 ^{a)}
		0,75	3,42 ^{a)}	3,42 ^{a)}	3,42 ^{a)}	3,42 ^{a)}	3,42 ^{a)}
		0,88	4,06 ^{a)}	4,06 ^{a)}	4,06 ^{a)}	4,06 ^{a)}	4,06 ^{a)}
		1,00	4,67 ^{a)}	4,67 ^{a)}	4,67 ^{a)}	4,67 ^{a)}	4,67 ^{a)}
max. Head displacement u depending on the sandwich panel thickness D [mm]	30	1,0	1,0	1,0	1,0	1,0	
	40	2,0	2,0	2,0	2,0	2,0	
	50	3,0	3,0	3,0	3,0	3,0	
	60	4,0	4,0	4,0	4,0	4,0	
	70	5,0	5,0	5,0	5,0	5,0	
	80	6,0	6,0	6,0	6,0	6,0	
	100	6,0	6,0	6,0	6,0	6,0	
	120	6,0	6,0	6,0	6,0	6,0	
≥140	6,0	6,0	6,0	6,0	6,0		

If component I consists of S320GD or S350GD, allowed me to ^{a)} values marked be increased by 8.3%.

<p>Fastening screws for sandwich panels</p> <p>BiGHTY SWPS DSS 6,3/5,5 x L with hexagon head and sealing washer $\geq \text{Ø}19 \text{ mm}$</p>	<p>Annex 13</p>
---	------------------------