



Eurotec[®]

The specialist for fastening technologie

FASTENING FOR THE ■■■■
**CONSTRUCTION
WITH CLT**

WOOD CONNECTORS

SCREWS

BIM-PORTAL

SPECIAL COMPONENTS



www.eurotec.team/en

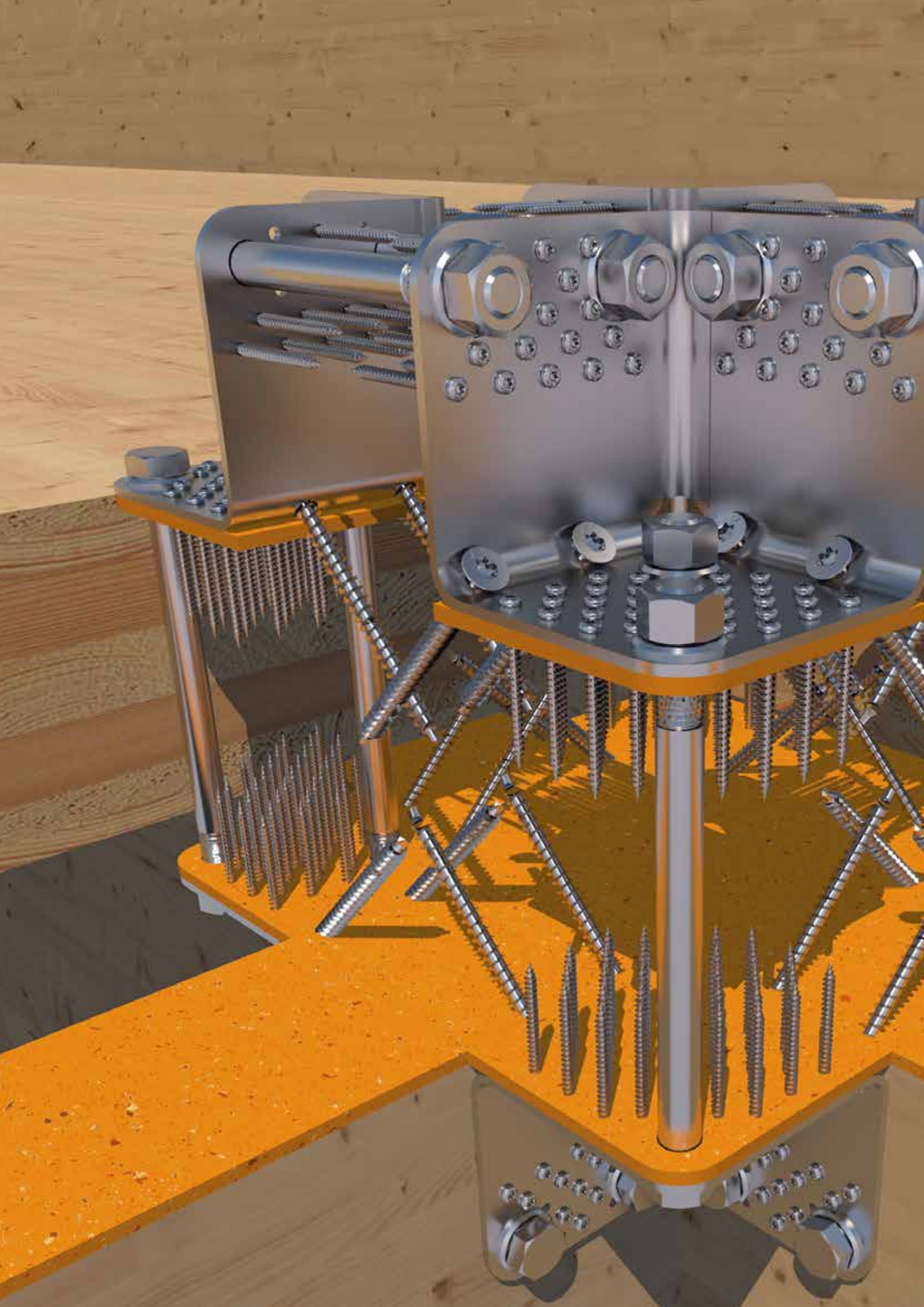



Solid timber construction

Product finder	4 – 5
Company portrait	6 – 9
Eurotec Coach	10
Eurotec BIM online portal	11
CLT Basics	12 – 15
Wood connectors	16 – 73
Screws	74 – 133
Further products	134 – 175
Special components	176 – 178

PRODUCT FINDER

	Sill plate	Wall-Concrete	Wall-Wall	Beam	Wall-Ceiling
WOOD CONNECTORS					
CLT system inside corner	x	x	✓	x	✓
CLT system angle	x	x	✓	x	✓
Shearing angle	x	✓	✓	x	✓
HB flat shearing angle	x	✓	x	x	x
HH flat shearing angle	x	x	x	x	x
Shearing plate	x	✓	✓	x	x
Tension strap HB60/70	✓	✓	x	x	x
Tension strap HH60/70	x	x	✓	x	✓
Shear wall connector	x	x	✓	x	x
Assembly connector	x	x	✓	x	x
Magnus hook connector	x	x	x	✓	x
T-profile	x	x	x	✓	x
Hidden ground anchor	x	x	x	x	✓
SCREWS					
Rock concrete screw	✓	✓	x	x	x
KonstruX fully threaded screw	x	x	✓	✓	✓
Angle-bracket screw	x	✓	✓	x	✓
Paneltwistec	x	x	✓	✓	✓
SawTec	x	x	✓	✓	✓
Topduo roofing screw	x	x	x	x	x
FURTHER PRODUCTS					
Lifting anchor, ball supporting bolt	x	x	x	x	x
IdeeFix	x	✓	x	✓	✓
SonoTec sound insulation cork	✓	✓	✓	✓	✓
Bolt anchor	✓	x	x	x	x
Silent EPDM decoupling profile	✓	✓	✓	✓	✓
Ecktec	x	x	x	x	x

✓ USABLE

✗ NOT USABLE

— IRRELEVANT

Ceiling-Ceiling	Wall-Floor	Roof	Stairs	Insulation	Handling	Page
✗	✓	-	-	-	-	18 – 23
✗	✓	-	-	-	-	24 – 27
✗	✓	-	-	-	-	28 – 31
✗	✗	-	-	-	-	32 – 33
✗	✓	-	-	-	-	34 – 35
✗	✗	-	-	-	-	36 – 39
✗	✗	-	-	-	-	40 – 41
✗	✓	-	-	-	-	42 – 43
✗	✗	-	-	-	-	44 – 45
✗	✗	-	-	-	✓	46 – 47
✗	✗	-	-	-	-	48 – 67
✗	✗	-	-	-	-	68 – 71
✗	✓	-	-	-	-	72 – 73
✗	✗	✗	✗	✗	-	76 – 79
✓	✓	✓	✓	✓	-	80 – 107
✓	✓	✗	✗	✗	-	108 – 109
✓	✓	✓	✓	✓	-	110 – 123
✓	✓	✓	✓	✓	-	124 – 127
✗	✗	✗	✗	✓	-	128 – 133
✗	✗	✗	✗	✗	✓	136 – 147
✗	✓	✗	✗	✗	-	148 – 154
✓	✓	✓	✗	✗	-	156 – 167
✗	✗	✗	✗	✗	-	168 – 171
✓	✓	✗	✓	✗	-	172 – 173
✗	✗	✗	✗	✗	✗	174 – 175

ABOUT EUROTEC

We are a medium-sized company engaged in the development, production and sale of products for the construction sector. To this end, we supply products

for the areas of timber-frame construction, deck construction and concrete fastening. We supply specialist dealers across Europe, who are responsible for distribution to skilled craftsmen.

OUR MILESTONES

1999

The two managing directors, Gregor Mamys and Markus Rensburg, founded Eurotec GmbH on 1 May 1999. The company began its life in a small basement with an adjoining garage, whose 5 pallet bays served as a warehouse.

2003

After multiple relocations within Hagen, the decision was made in 2003 to move to a company building in Werkzeugstraße. At the time, the warehouse had space for approx. 300 pallet bays. This warehouse also quickly became too small. After several expansions, capacity ran out and it was time for a new company building! The managing directors looked for and found a suitable location in Hagen.

2007

In 2007, the Eurotec team and its 30 members of staff moved into the new building at Unter dem Hofe 5. These newly built premises consisted of an office wing and an adjoining warehouse with approx. 3,500 pallet bays.

2010

Just three years later, the new building would, in turn, become the old building. A new warehouse building was built, providing a further 7,500 pallet bays and offices upstairs.

2012

In 2012, we decided to take the next important step. The foundation stone was laid for the production hall, paving the way for in-house production.

2013

From 7 January 2013 onwards, we produced a selected part of our proprietary product range in our own production hall in Hagen.

2014

In 2014, intensive work began on further expanding in-house production.

2015

Production capacity is expanded in 2015 to enable us to offer a wide range of solutions from our very own production facilities.

2016

In 2016, the company starts actively to build a new hall to relocate its machinery. Additional office space is being created in Hagen, since the company is enjoying steady growth. The next step is to expand the storage capacities in what was formerly the machinery hall.

2018

Completion of the new production hall in early 2018 means that all of the machinery can be moved. Construction work starts on another warehouse.

2019

On 1 May 2019 we celebrated our company's 20th anniversary. The injection moulding is extended by two additional injection moulding machines to a total of four machines. In addition the screw production is expanded by another multi-stage press. So we now have a total of five machines for screw production at our disposal.

2021

Our fleet of machinery continues to grow. Two more plastics machines will be added to our company's stock this year. We are expanding our online offering also, with the valuable Eurotec Coach and Eurotec BIM online portal.

SO, AN END IS STILL NOT IN SIGHT ...



IN-HOUSE PRODUCTION IN HAGEN

When production began in 2013, we took an important step forward in the company's history. Our success and ever-growing production facilities show that we are establishing ourselves in the market with our products. The benefits of in-house production are obvious, as we can better implement and constantly monitor our customers' high quality requirements. Short delivery times and swift responses to the demand of the market are additional advantages.



QUALITY MANAGEMENT

Quality forms the basis for all of Eurotec's activities. Offering our customers flawless products and services and ensuring 100% adherence to deadlines are our prime objectives.

We expect an unreserved commitment to quality from each of our employees. Training and further development of customer- and quality-oriented mindset and acting is always in the priority. The compliance with legal and regulatory requirements in an economic framework, while promoting environmentally conscious action, is an obligation for us.

QUALITY FROM EUROPE – AND WE'RE PROUD OF IT!

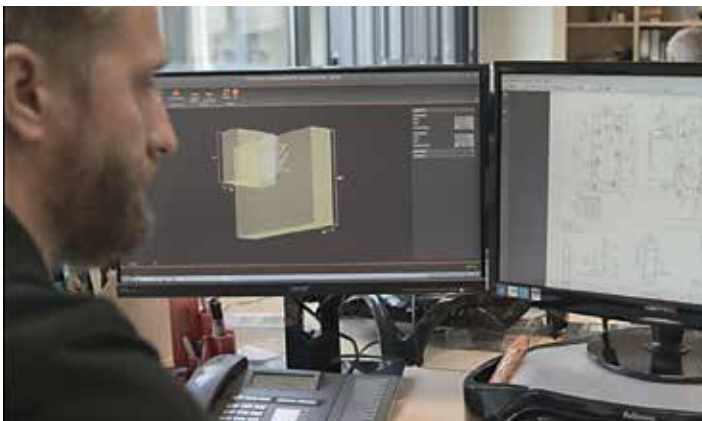

CALCULATIONS AND PLANNING

Gladly we will advise you on your construction projects. Contact our engineering department or use the free calculation software in the service section of our website: www.eurotec.team

For calculations and planning in the areas of terrace construction, timber construction, concrete, façade, we are happy to assist you.



SCREW PRODUCTION

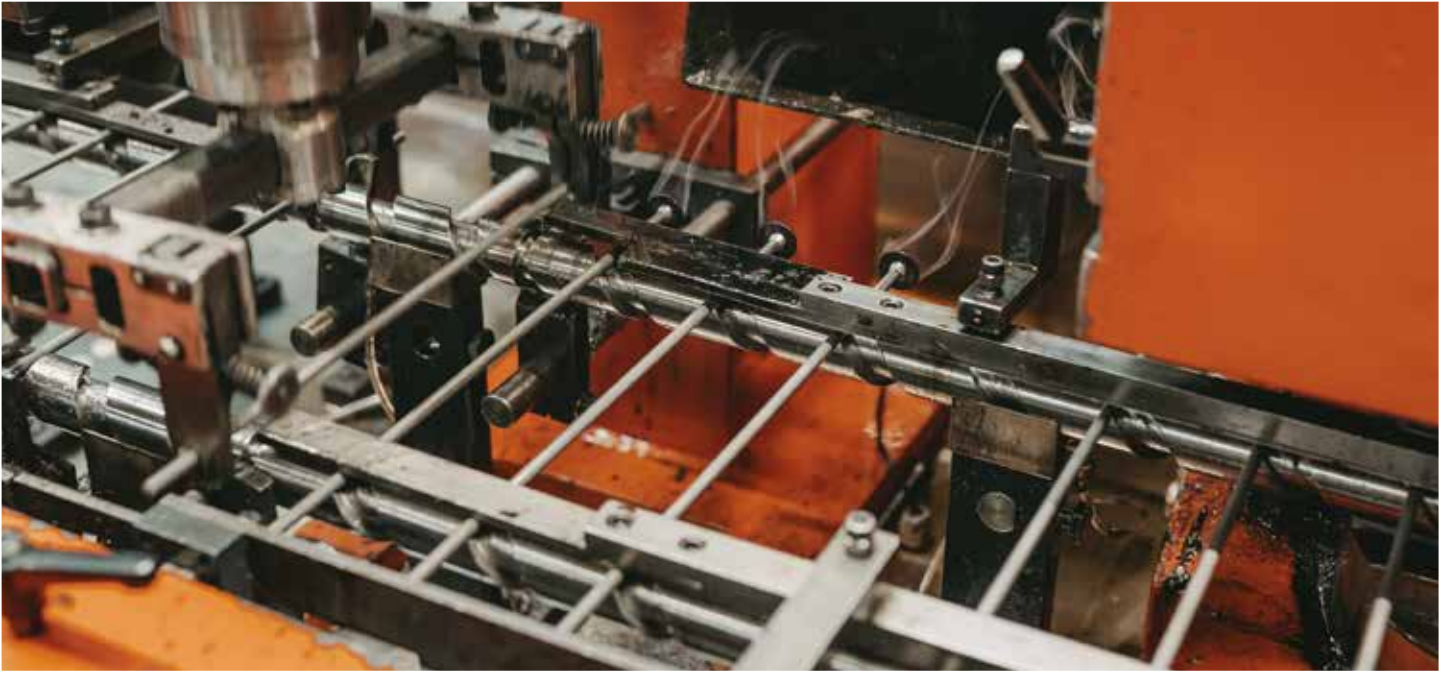

Since the start of production in 2013, production has expanded steadily. We now manufacture an ever-increasing part of our screw range ourselves at the Hagen site. These include a number of special construction screws, for example, including the KonstruX fully threaded screws or Topduo roofing screws.

We make cold formed parts with a diameter of up to 10 mm and a length of up to 1,000 mm in our production facility. We can automate up to 8 machining steps on our machines, which makes our work very cost-effective. Relocating the production facilities to a bigger hall meant that this area would also be expanded to include additional machines.



QUALITY ASSURANCE AND CERTIFICATIONS



Our ultimate goal is to provide our customers with flawless products and services. We also guarantee 100% adherence to delivery dates. We expect every one of our employees to commit to quality unwaveringly. Training and further development of customer- and quality-oriented ways of thinking and acting are always in focus. We feel duty-bound to comply with legal and regulatory requirements and within a given economic framework, while at the same time promoting environmentally conscious action.

We are proud of the fact that almost all of our products in the wood, façade and concrete segments are ETA-certified. It goes without saying that our quality assurance does daily checks on the batches produced for standards such as conformity to drawings, functionality, appearance, and compliance with customer-specific specifications. That is the only way we can be sure to deliver the consistently high quality our customers have come to expect from us.



QUALITY FORMS THE BASIS
OF ALL OUR ACTIVITIES.



Eurotec[®] COACH



On construction site, not all processes run according to plan and sometimes there may be a lag of technical understanding, basic knowledge or the correct organisation of the workflow. With our new format **Eurotec Coach** we provide all the required knowledge with the help of **videos**, brochures and expert articles which you require to become a **pro!**

✳️ SOON AVAILABLE ✳️
✳️ ON OUR **WEBSITE** ✳️

OUR BIM-ONLINE PORTAL – ALL DATA AT ONE SIGHT

NEW

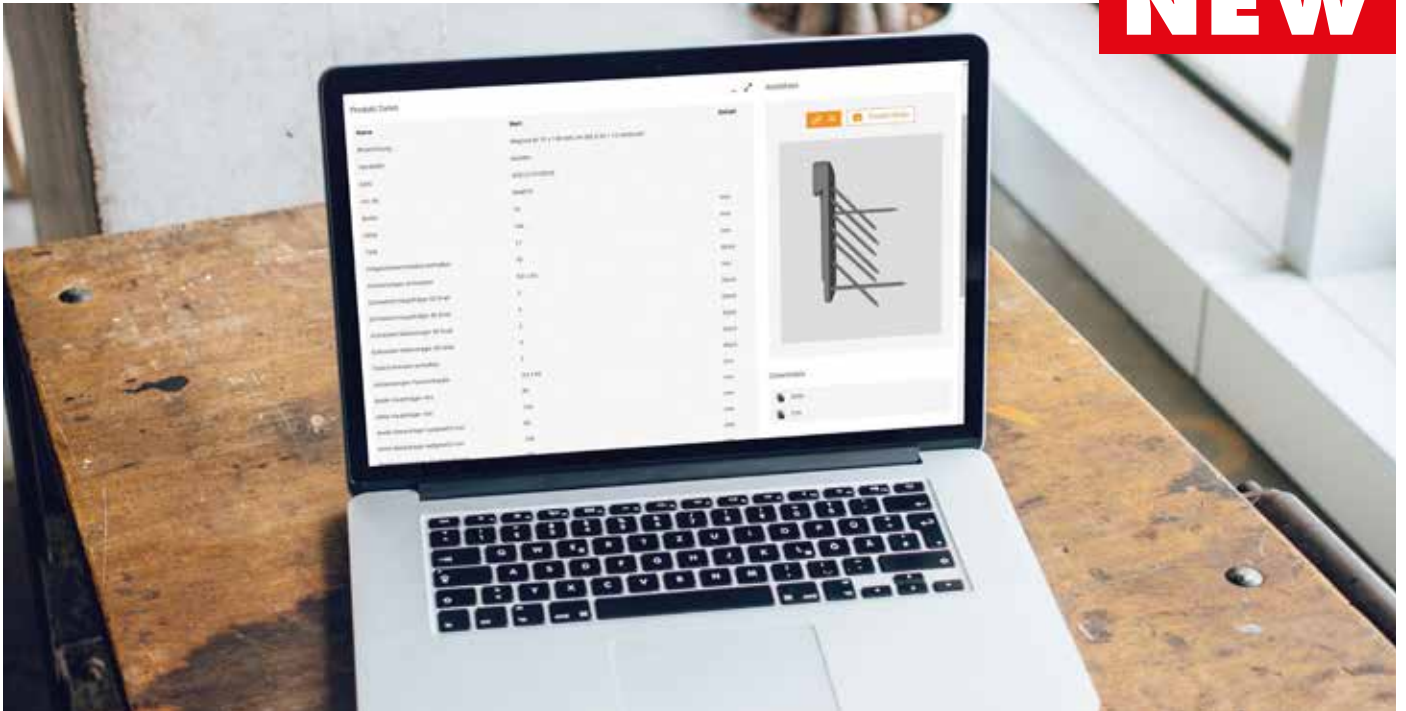

Many people are involved in the construction of a building, such as architects, planners, craftsmen and service providers. All these people need important data and information for their work.

In our new Eurotec BIM online portal, we provide you with up-to-date BIM-relevant data for our product range.

You have full access to 3D/CAD data, DWG files, important product information, ETA certifications and much more. All functions of the portal are

available to you free of charge! The download of the files is possible after a quick registration.

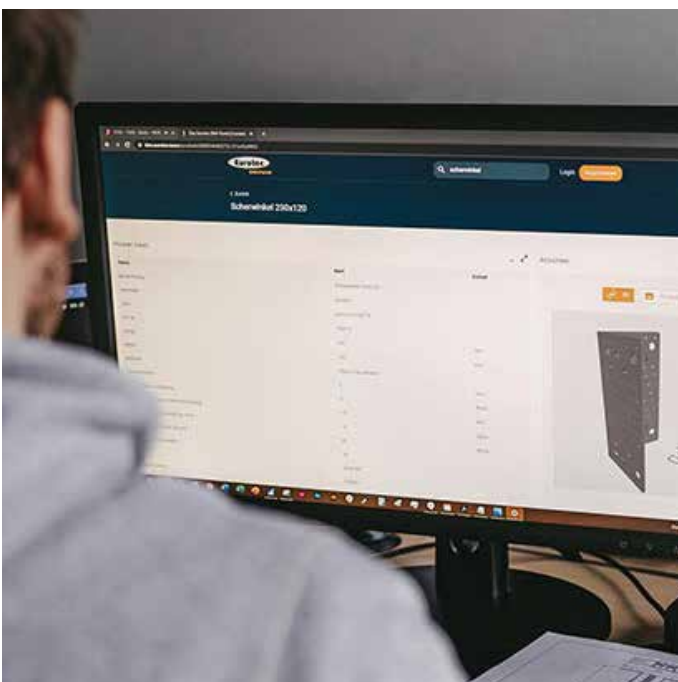

CLT BASICS



CLT (Cross Laminated Timber) panels consist of several layers of wooden boards stacked crosswise (typically at an angle of 90 degrees). They are glued together on their broad faces and sometimes also on the narrow faces.

A cross-section of a CLT element has at least three bonded sheet layers arranged in an alternating way and orthogonal to the adjacent layers. In special configurations, successive layers can be arranged in the same direction, creating a double layer (for example, double longitudinal layers on the outer surfaces and/or additional double layers at the core of the panel) to achieve specific structural capacities.

CLT products will typically be manufactured with an odd number of layers. Gluing three to seven layers together is common. The thickness of the individual layers of wood can vary from 16 mm to 51 mm, while the width can vary from about 60 mm to 240 mm.

The panel sizes vary depending on the manufacturer. Typical widths are 0.6 m, 1.2 m, 2.4 m, and 3 m. The length can be up to 18 m. In special cases, the thickness can be up to 500 mm. Typical thicknesses are between 60 and 300 mm, however. (Transport regulations may limit the CLT panel sizes).

The timber in the outer layers of the CLT panels that are used as walls are aligned up and down, parallel to the gravity loads, to maximise the vertical loading capacity of the wall. Similarly, in floor and roof systems, the outer layers run parallel to the main tension direction.

ADVANTAGES OF BUILDING WITH CLT

- CLT allows screw connection in any direction, irrespective of the grain direction, as the layering of the boards means that no grain direction has to be observed.
- Reduced construction time due to prefabrication of the elements
- Enables almost film-free construction due to the diffusion-open properties of the CLT elements.
- CLT has both sound and heat insulating properties.
- A wide range of architectural design options.
- All components of a house (walls, ceilings, and roof) can be made of CLT.
- Lower weight compared to concrete and bricks
- No construction waste when demolishing buildings. CLT is completely ecologically recyclable.

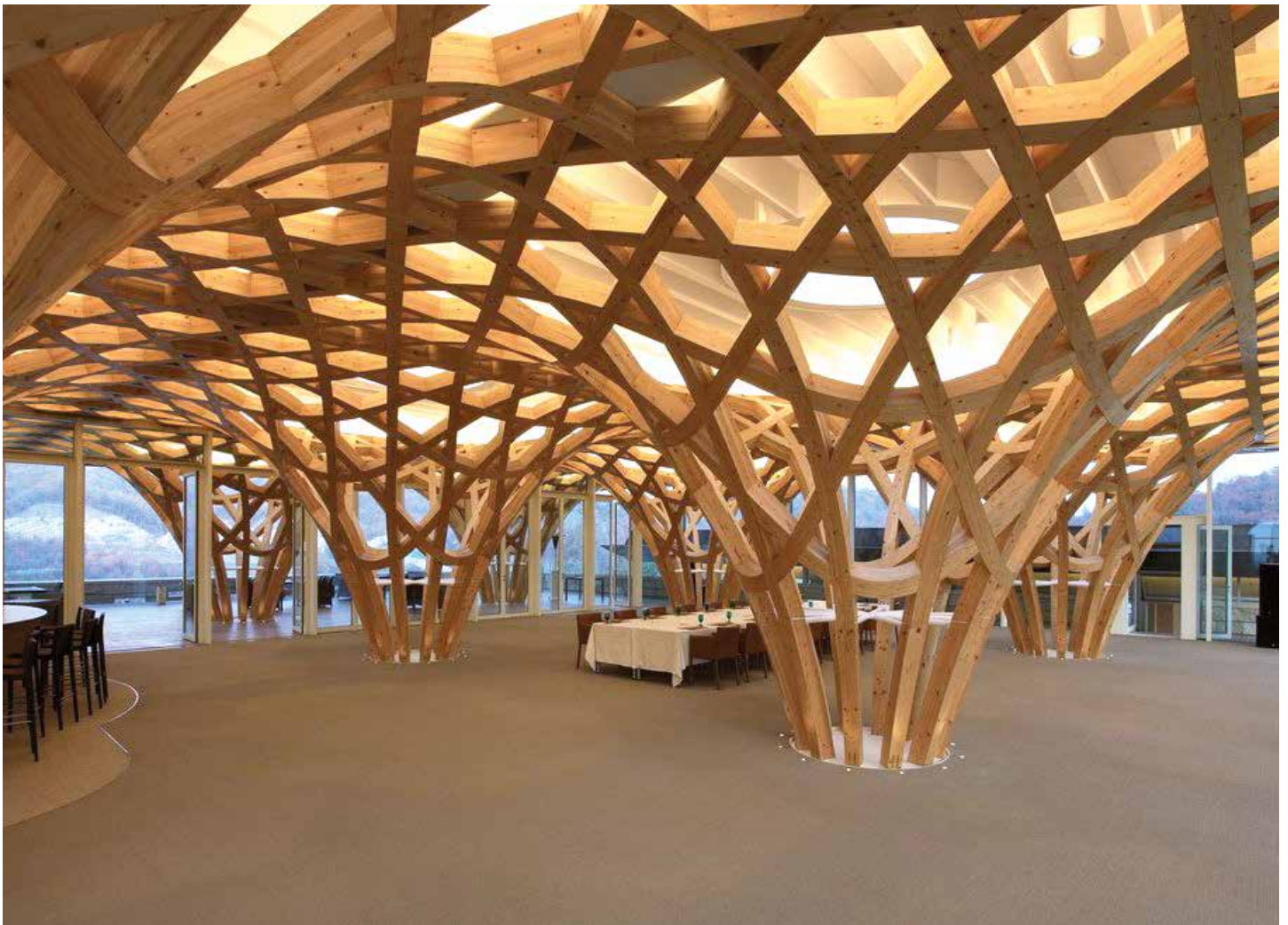

PRODUCTION OF CLT

1

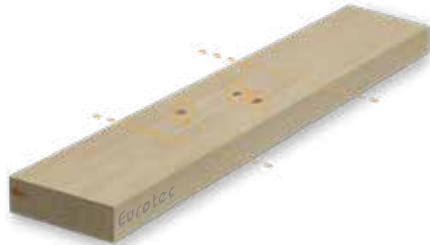

The boards are sorted after the softwood boards have gone through a drying process (more than 48 hours). Growth deviations in the wood that would reduce the strength, or are simply unsightly, are marked. The sections that have such defects are cut out.

2



The boards of different lengths are joined together to create an almost endless strand of wooden boards, which is necessary for CLT production. This is done by means of finger joints. The resulting boards are then planed to eliminate thickness deviations between the boards.

3



The manufactured boards are applied manually or mechanically to form a layer. Adhesive is applied to the resulting surface after a layer has been completely applied. The most common method here is a glue curtain through which the layer is passed.

4



Another layer is placed on top of the glued layer. This is aligned so that the fibre direction of the new layer runs at an angle of 90° to the fibres of the board below. Glue is then applied to the new layer also. This process is repeated until the desired number of board layers is achieved.

5



Once the desired number of layers is reached, the glued lamellas are pressed. The size of the press bed determines the possible panel size. As soon as the adhesive has cured, the CLT panel is reworked to remove any dirt, adhesive residues, or protruding wood. This is done by planing and grinding the CLT panel.

BUILDING WITH CROSS LAMINATED TIMBER

The construction phases of modern timber construction methods, such as building with cross laminated timber, are very different from that of the conventional solid construction method. Whereas with solid construction most of the work takes place on the building site, with timber construction much of the work has now shifted from the construction site to the factory.

The keyword here is prefabrication. All wall, ceiling, and roof elements are delivered to the construction site not as unprocessed CLT panels and thus raw material. They are prepared in special joinery centres for later assembly.

In the CNC joinery centres, the manufactured CLT panels are further processed into individual elements. All necessary work that is required on the construction site for fasteners of all kinds and/or for geometries that would be too difficult to realise on the construction site, is carried out here. Common joinery work carried out in the factory includes:

- Windows and door cut-outs
- Angled cuts in the gable area
- Cuts and notches
- Milling of folding systems (for example: joint deck board fold, tier fold)
- Special geometries for special connectors

Such complex processing steps, especially through the use of computer-controlled processing machines, increase the amount of upfront planning work. Positions for connectors and installations within the house (electrical/water) must be able to be provided with the necessary information. Furthermore, care is taken to ensure that all components are matched to each other to the millimetre in the final assembly, so that there are no problems in the final assembly.





Wood connectors

WOOD CONNECTORS

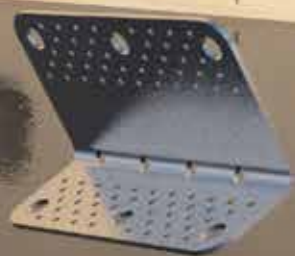



Wood connectors

CLT system inside corner	18 – 23
CLT system angle	24 – 27
Shearing angle	28 – 31
HB flat shearing angle	32 – 33
HH flat shearing angle	34 – 35
Shearing plate	31– 39
Tension strap HB 60 / HB 70	40 – 41
Tension strap HH 60 / HH 70	42 – 43
Shear wall connector	44 – 45
Assembly connector	46 – 47
Magnus hook connector	48 – 67
T-profile	68 – 69
EST dowel bar	70
Dowel bar	71
Hidden ground anchor	72 – 73

CLT SYSTEM INSIDE CORNER

DEVELOPED FOR MODERN TIMBER CONSTRUCTION

NEW
to our product range

ADVANTAGES

- Combining several CLT system inside corners, an effective connection of different elements with each other is created
- Fewer connectors required
- Versatile applications



INSTRUCTIONS FOR USE

The CLT system inside corner can be used to connect internal corners with each other. It can be used both individually and in combination with several CLT system inside corners. A hexagon head screw can be led from one element, through the wall, to the other element, for this purpose. If this is applied in all possible directions, a stable construction for wall nodes is created. This can also be achieved with the combination of our IdeeFix. Although the individual corners are not directly connected to each other, it results in a very secure connection between the wall and ceiling or floor elements.

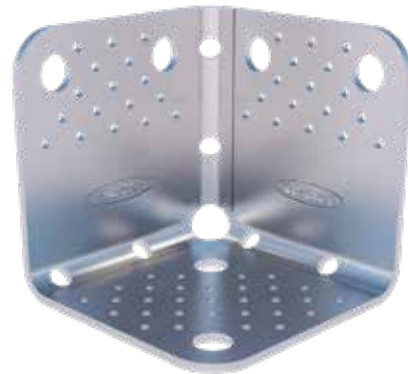

Suitable for use with:
KonstruX (p. 80), IdeeFix (p. 148)
Angle-bracket screw (p. 108)



CLT system inside corner for fixing two walls to the wooden floor of the upper floor.



Versatility is very important to us. One of our new products is the **CLT system inside corner**. A strong connection of wall nodes is achieved when it is used in combination. The inside corner is also an unbeatable solution for **timber-timber connections** at corner points.

✳ **CLT SYSTEM** ✳
✳ **INSIDE CORNER -** ✳
✳ **COMING SOON** ✳

CLT SYSTEM INSIDE CORNER – COMBINATION

The CLT system inside corner is an extremely combinable connector. Wall nodes can be connected in a number of different ways.

A construction can be extremely strengthened by connecting several interior corners of a system through the wood. This can be achieved with our IdeeFix or also hexagonal bolts, for example. There are numerous possibilities.

In contrast to using the connector individually (see examples), the most force can be absorbed and distributed when the internal corners of the system are positioned opposite each other.

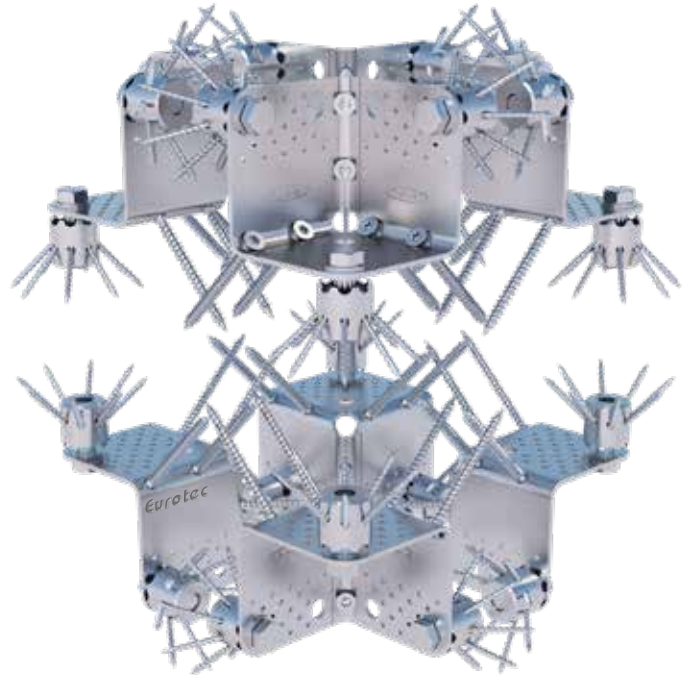

With KonstruX and IdeeFix



With KonstruX and Hexagon head screw M16

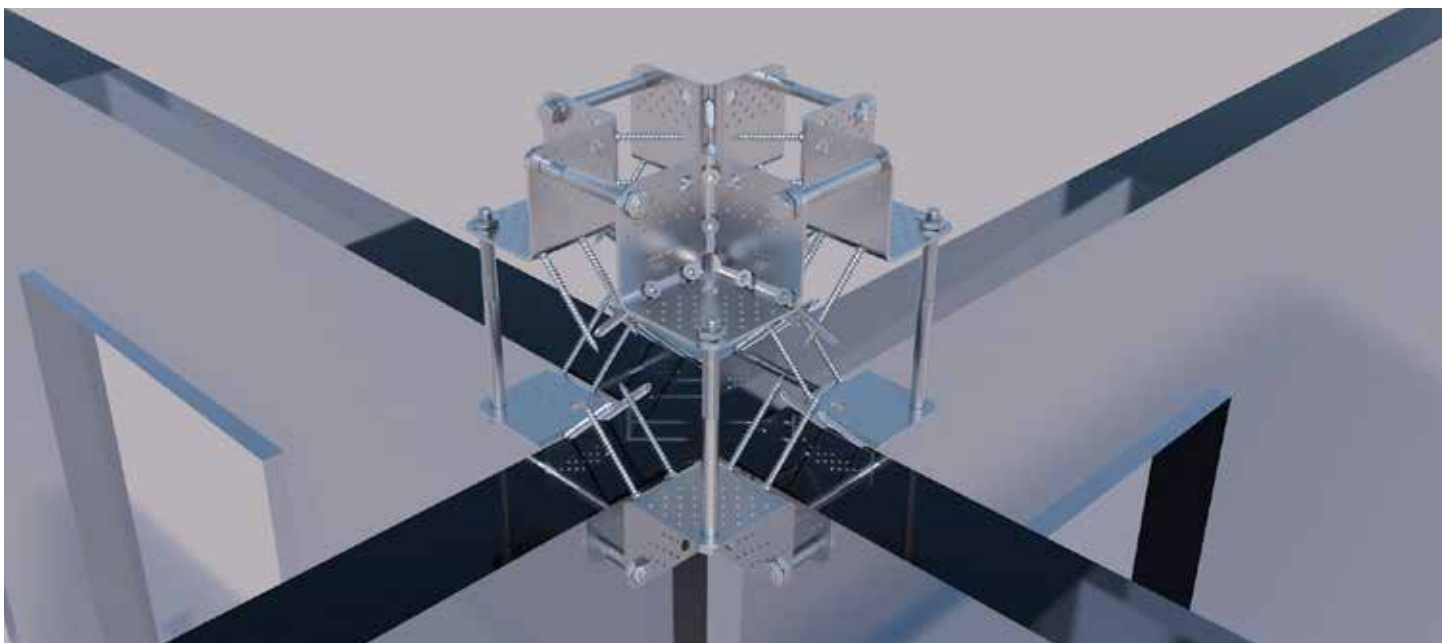

With Hexagon head screw M16 built into ceiling and walls

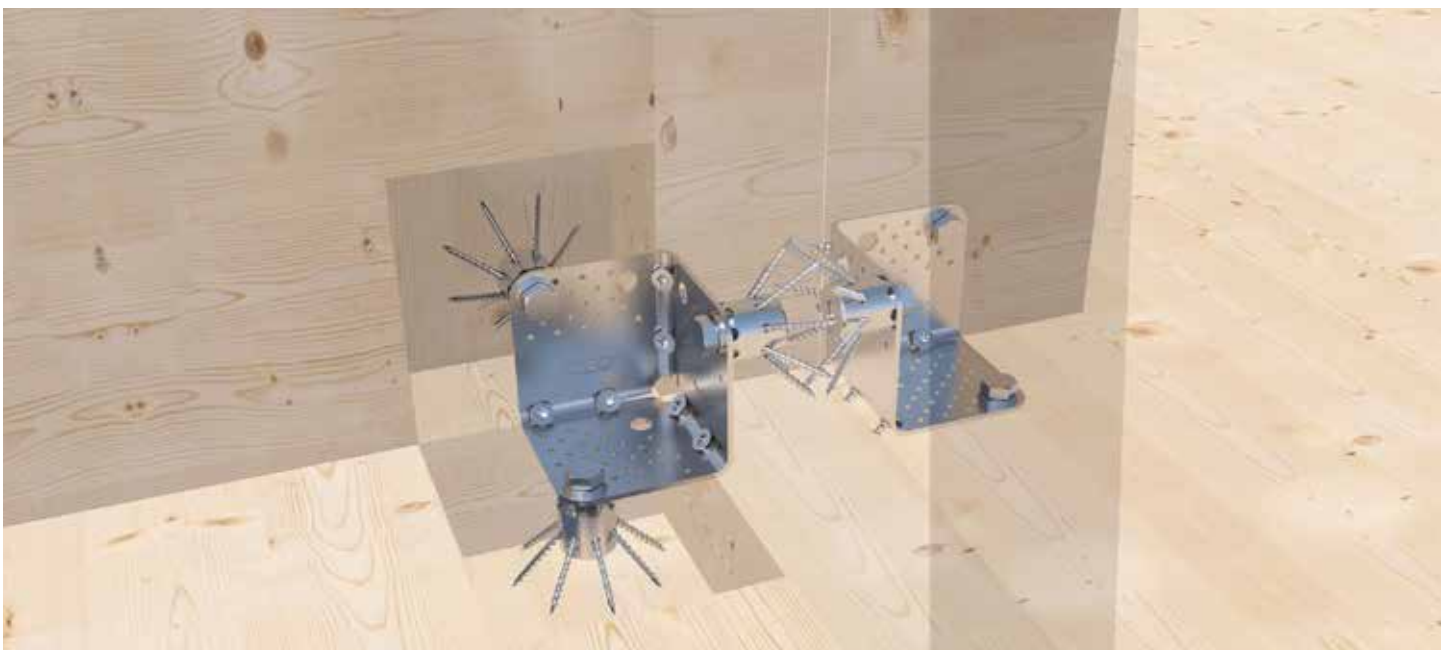

Partial construction from two system inside corners in combination with the IDEE*Fix*

POSSIBLE APPLICATIONS

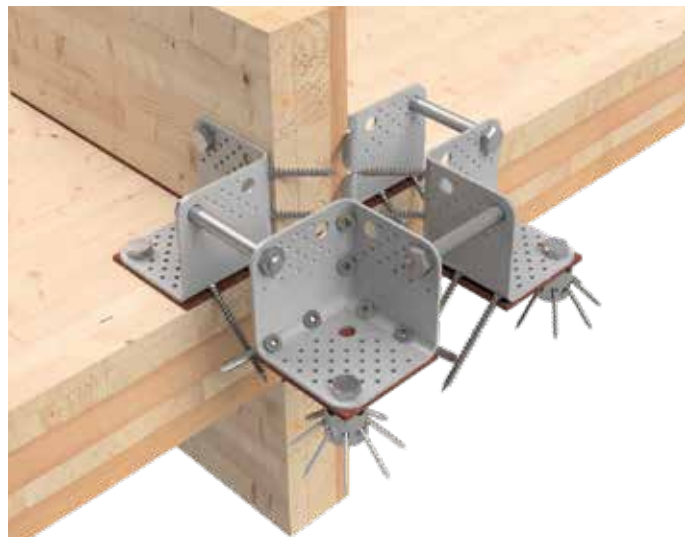
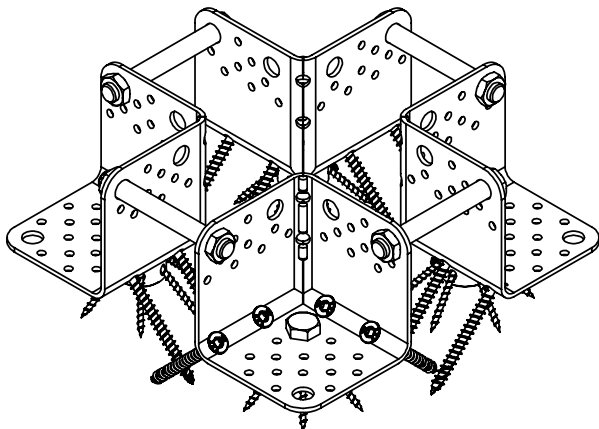
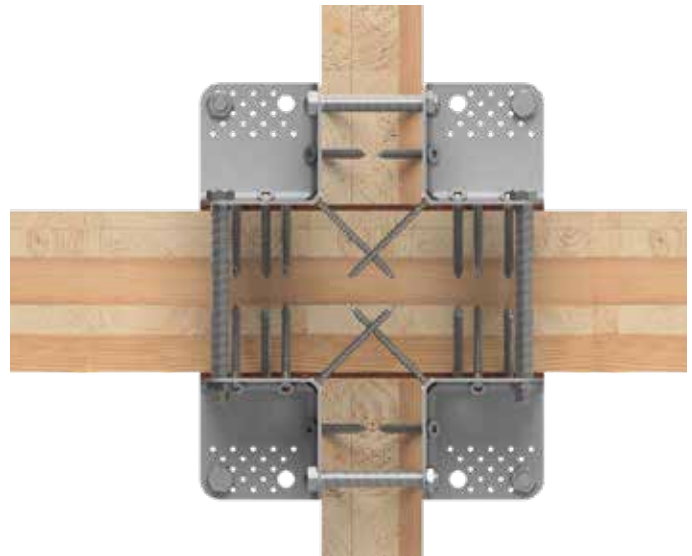
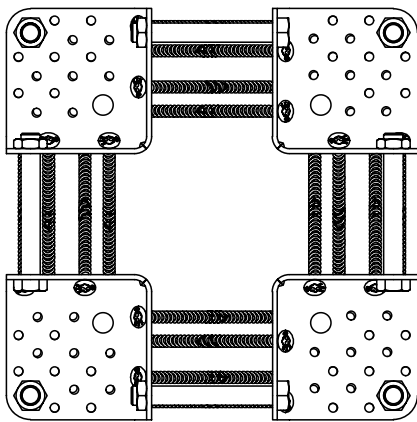
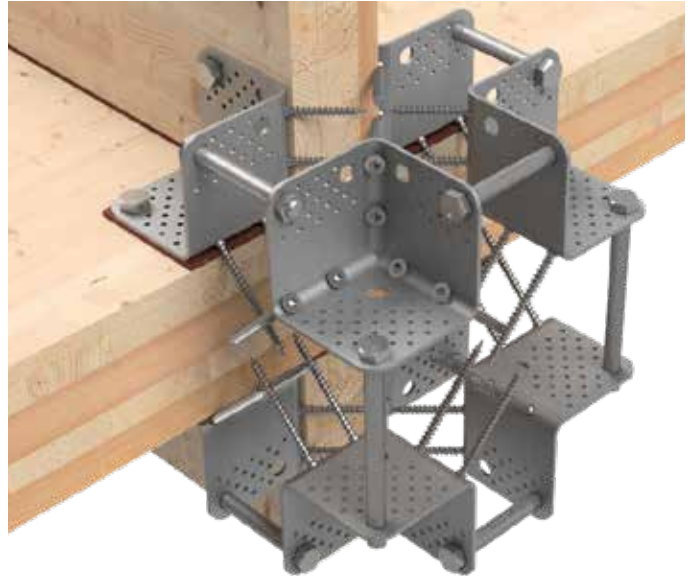
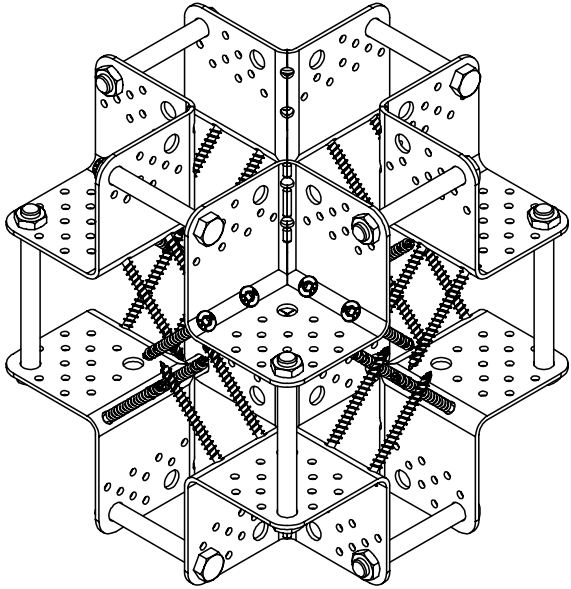

WALL JUNCTION – VISIBLE SOLID WOOD CEILING

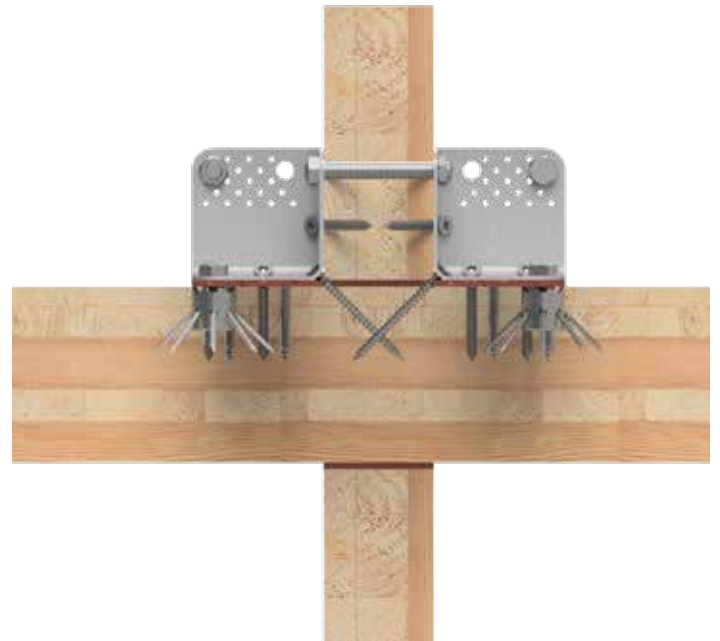
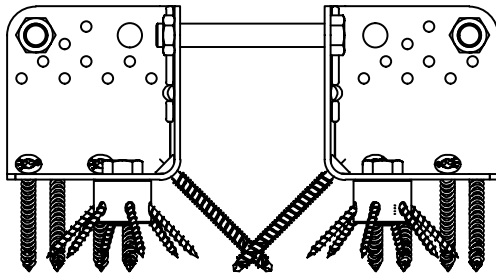

CANTILEVER STRUCTURES

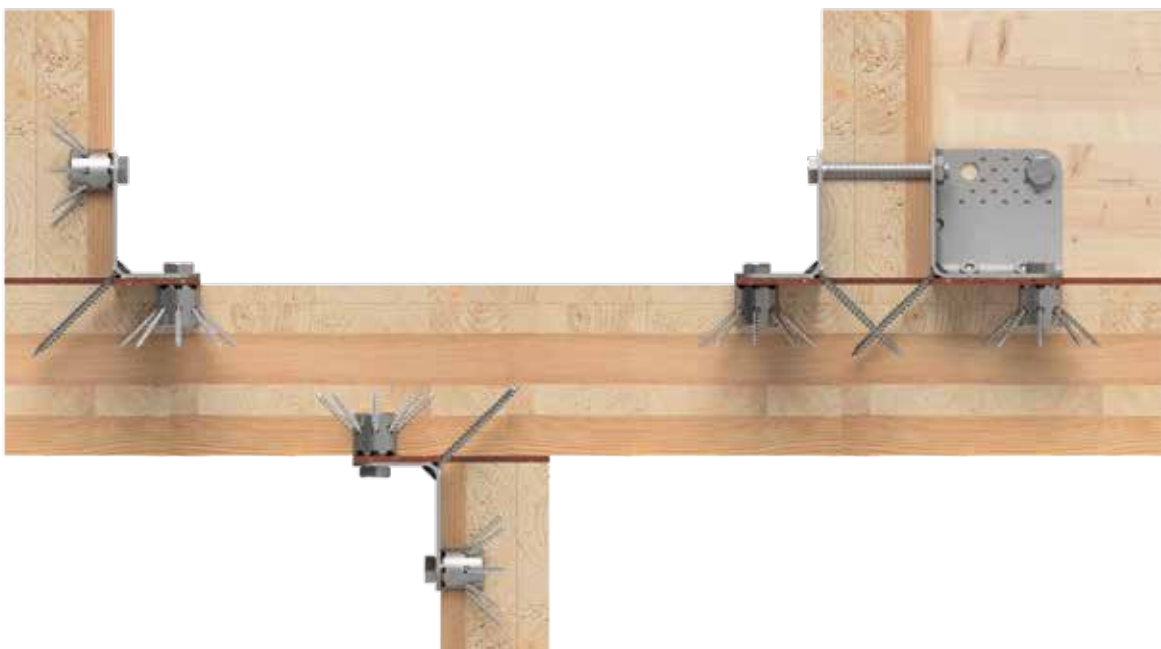

CLT SYSTEM ANGLE

DEVELOPED FOR MODERN TIMBER CONSTRUCTION



ADVANTAGES

- High load bearing capacity
- Versatile applications
- Compatible with SK04

DESCRIPTION

The CLT system angle is ideally suited for use in solid timber construction. The scope of application is limited to the use of CLT (cross-laminated timber). The solid construction allows it to transmit major forces. In contrast to the standard angles (on the following pages), the system angle CLT can be combined with our **IdeeFix**. This makes it possible to construct complex connections.



INSTRUCTIONS FOR USE

Either 5 x 60 mm angle fitting screws or the Paneltwistec 5 x 120 mm, in combination with the KonstruX CH 10 x 125 mm, are used for the CLT system angle. When used with **IdeeFix**, only 4 **IdeeFix** and 4 KonstruX are needed – see application picture. It is possible to combine **IdeeFix** and screw bolts through a wall also. The load values, which are regulated according to ETA, must be observed. For further information, please contact our technical department technik@eurotec.team or +49 2331 6245-444.

Suitable for use with:
 KonstruX (p. 80), IdeeFix (p. 148)
 Angle-bracket screw (p. 108)
 SonoTec Angular Decoupler (p. 156)

Art. no.	Name	Dimensions [mm] ^{a)}	Material	Material thickness [mm]	PU
954180	CLT system angle	230 x 80 x 120	S250 Galvanised	4	1

a) Length x Width x Height



CLT system angle for fixing a wall to the wooden floor of the upper level.

EXAMPLES OF COMBINATIONS

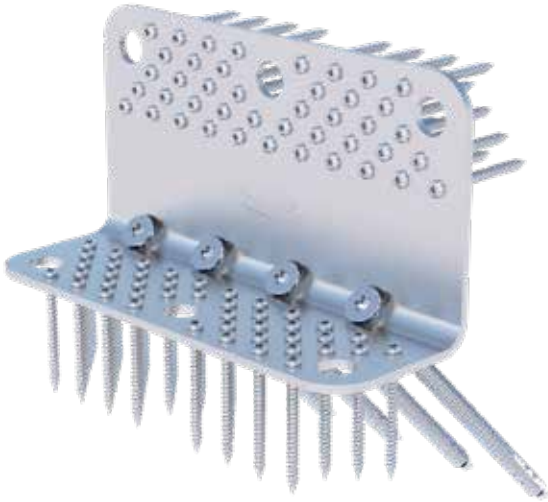

KonstruX + Angle-bracket screw 5 x 60 mm

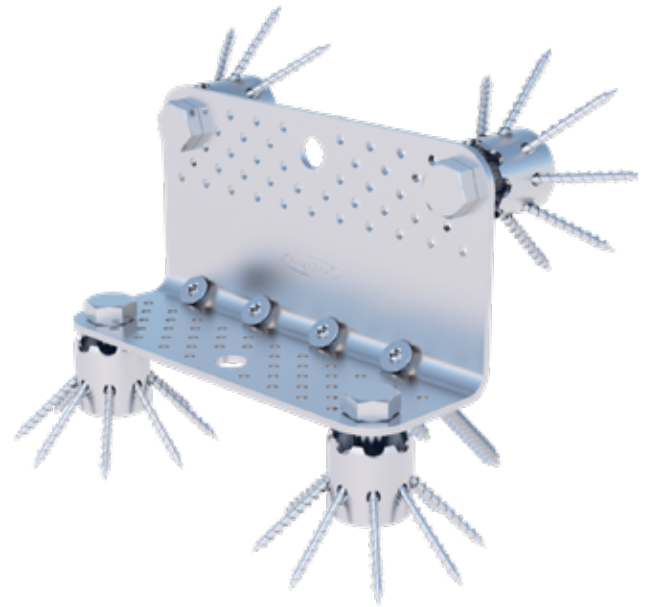

KonstruX + IdeeFix

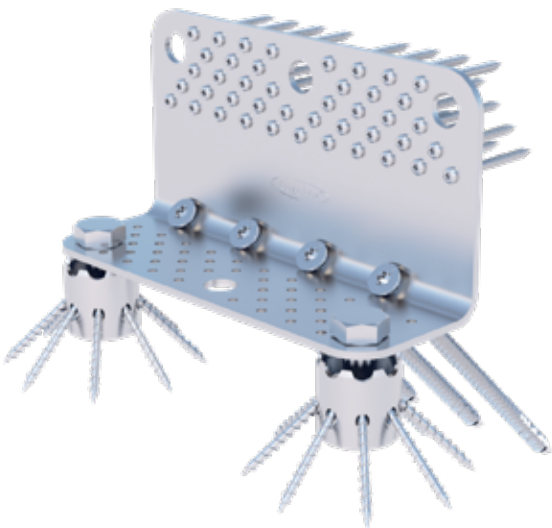

KonstruX + Angle-bracket screw + IdeeFix



Connected with M16 hexagon head screws

CLT SYSTEM ANGLE – STATIC VALUES

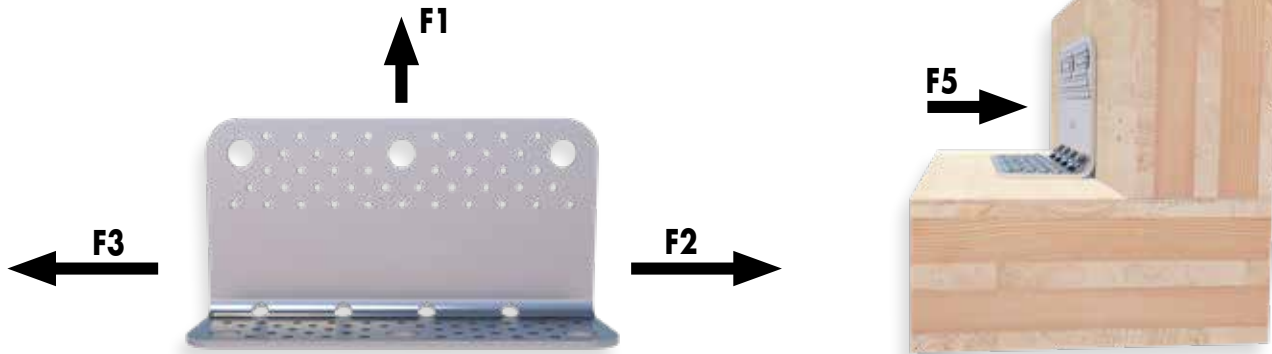

Load direction F1; F2/F3; /F5

Vertical leg connection Angle-bracket screw Ø 5 mm n=43	5,0 x 40	5,0 x 50	5,0 x 60	5,0 x 70	5,0 x 40	5,0 x 50	5,0 x 60	5,0 x 70	5,0 x 40	5,0 x 50	5,0 x 60	5,0 x 70
Horizontal leg connection	Angle-bracket screw 5,0 x 40 n=43	Angle-bracket screw 5,0 x 50 n=43	Angle-bracket screw 5,0 x 60 n=43	Angle-bracket screw 5,0 x 70 n=43	IdeeFix Ø 40 n=3	IdeeFix Ø 40 n=3	IdeeFix Ø 40 n=3	IdeeFix Ø 40 n=3	M16 8.8 n=3	M16 8.8 n=3	M16 8.8 n=3	M16 8.8 n=3
KonstruX 10 x 125 n=4												
F_1, R_k pull [kN]	55,8	62,4	69,1	75,7	43,1	43,1	43,1	43,1	43,1	43,1	43,1	43,1
F_{23}, R_k [kN]	49,1	58,3	62,1	66,0	49,1	55,9	55,9	55,9	49,1	58,3	62,1	66,0
F_5, R_k pull ⊥ on CLT [kN]	6,9	6,9	6,9	6,9	6,9	6,9	6,9	6,9	6,9	6,9	6,9	6,9

Load direction F1; F2/F3; /F5

Vertical leg connection	IdeeFix Ø 40 n=3	IdeeFix Ø 40 n=2	IdeeFix Ø 40 n=3	IdeeFix Ø 40 n=2	IdeeFix Ø 40 n=3	IdeeFix Ø 40 n=2
Horizontal leg connection	Angle-bracket screw 5,0 x 40;50;60;70 n=43	Angle-bracket screw 5,0 x 40;50;60;70 n=43	IdeeFix Ø 40 n=3	IdeeFix Ø 40 n=2	M16 8.8 n=3	M16 8.8 n=2
KonstruX 10 x 125 n=4						
F_1, R_k pull [kN]	43,1	29,9	43,1	29,9	43,1	29,9
F_{23}, R_k [kN]	26,0	22,3	26,0	22,3	26,0	22,3
F_5, R_k pull ⊥ on CLT [kN]	4,8	4,8	4,8	4,8	4,8	4,8

Load direction F1; F2/F3; /F5

Vertical leg connection	M16 8.8 n=3	M16 8.8 n=2	M16 8.8 n=3	M16 8.8 n=2	M16 8.8 n=3	M16 8.8 n=2
Horizontal leg connection	Angle-bracket screw 5,0 x 40;50;60;70 n=43	Angle-bracket screw 5,0 x 40;50;60;70 n=43	IdeeFix Ø 40 n=3	IdeeFix Ø 40 n=2	M16 8.8 n=3	M16 8.8 n=2
KonstruX 10 x 125 n=4						
F_1, R_k pull [kN]	43,1	43,1	43,1	29,9	43,1	43,1
F_{23}, R_k [kN]	34,4	29,6	34,4	29,6	34,4	29,6
	29,3	25,2	29,3	25,2	29,3	25,2
F_5, R_k pull ⊥ on CLT [kN]	4,8	4,8	4,8	4,8	4,8	4,8

$F_4, R_k=54$ kN pressure ⊥ on CLT; independent of connections.

For connections with M18 8.8 if bolt head or nut is not located on CLT: Washer with $d_w=40$ mm.

$\rho_k=350$ kg/m³ conservative for some approved cross-laminated timber, increase of load-bearing capacities according to ETA-19/0020 with $k_{dens} = \left(\frac{\rho_k}{350 \text{ kg/m}^3} \right)^{0,5}$ possible.

The construction of the supporting structure should prevent the twisting of the cross laminated timber components.

In case of connection with CLT system angles on both sides, the values of this table may be applied for each of the two angles. The values for F_{23}, R_k only change for the connection with M16 screws.

In other words, the values in italics must be used if CLT system brackets are fitted to the top and bottom of the ceiling.

Please note: Verify the assumptions made. The stated values, and type and number of joining devices are based on preliminary measurements. Projects are to be dimensioned exclusively by authorised persons in accordance with the State Building Code. As per LBAU0, please contact a qualified structural engineer for a paid proof of stability. We will be happy to refer you to someone.

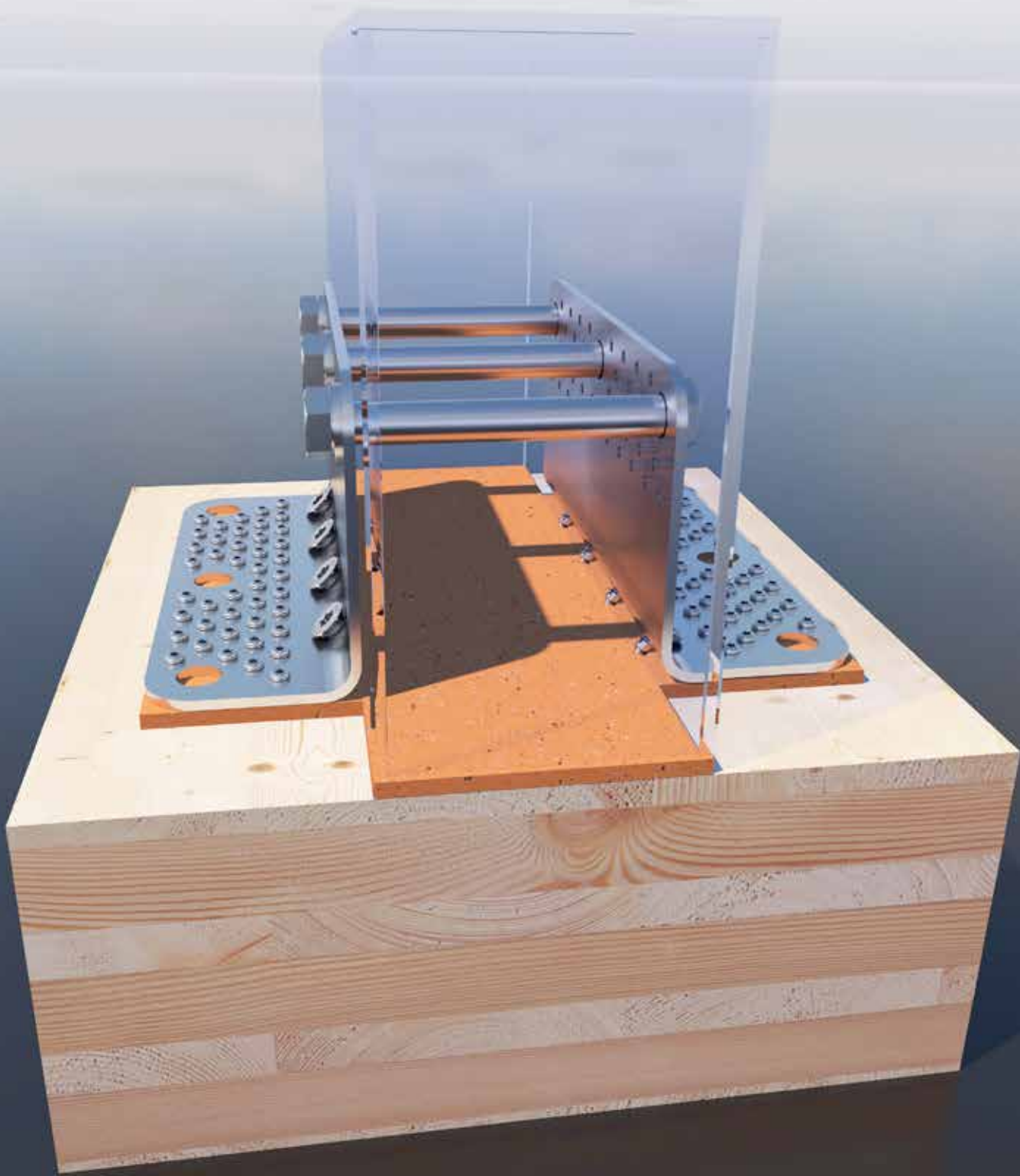

SHEARING ANGLE

CONNECTOR DEVELOPED FOR MODERN TIMBER CONSTRUCTION TO ABSORB SHEAR FORCES



ADVANTAGES

- Many different fields of application
- For installation in timber-concrete, as well as timber-timber connections
- Very high shear load-bearing capacity
- Fewer connectors required
- In combination with the pressure plate, the following tensile forces can be absorbed when fixing in concrete.

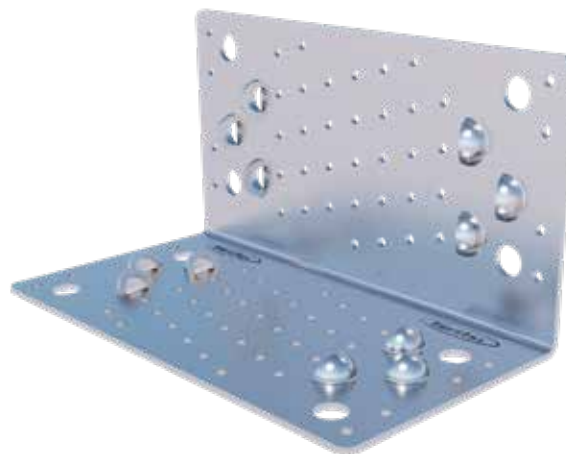

DESCRIPTION

The shearing angle is an angle bracket for absorbing shearing forces. This product was specifically developed for modern timber construction. Thanks to various holes for anchoring in timber and concrete, our shearing angle can be used in timber frame as well as solid timber construction.

Suitable for use with:
 Rock concrete screw (p. 76), Panelwistec (p. 110)
 Angle-bracket screw (p. 108), Bolt anchor (p. 168)
 Anchor nails (p. 37), Pressure plate (p. 29),
 SonoTec Angular Decoupler (p. 156)

Art. no.	Name	Dimensions [mm]	Material	Material thickness [mm]	PU
954112	Scherwinkel	230 x 120	S250 Galvanised	3	1



Shearing angle for fixing a wall to the concrete foundation.

Shearing angle pressure plate



Also suitable for use with:
HB flat shearing angle (p. 32)

Art. no.	Dimensions [mm]	Material	Material thickness [mm]	PU
954111	230 x 70	S235 Galvanised	12	1

SHEARING ANGLE – STATIC FULL UTILISATION VALUES



Load direction F2/F3						
Connection Timber-Timber						
Vertical leg connection	Anchor nails Ø 4 x 40 n=41	Anchor nails Ø 4 x 50 n=41	Anchor nails Ø 4 x 60 n=41	Angle-bracket screw Ø 5 x 40 n=41	Angle-bracket screw Ø 5 x 50 n=41	Angle-bracket screw Ø 5 x 60 n=41
	Panelwistec CH Ø 5 x 120 n=6					
Horizontal leg connection	Anchor nails Ø 4 x 40 n=41	Anchor nails Ø 4 x 50 n=41	Anchor nails Ø 4 x 60 n=41	Angle-bracket screw Ø 5 x 40 n=41	Angle-bracket screw Ø 5 x 50 n=41	Angle-bracket screw Ø 5 x 60 n=41
	Panelwistec CH Ø 5 x 120 n=6					
Char. Shear carrying capacity [kN]	30,5	36	37,2	41,9	44,6	47,6
Char. Shear carrying capacity [kN] (Use of SonoTec SK04)	22,6	26,6	27,5	32,7	34,8	37,1

The load-bearing capacities were determined based on ETA-19/0020 Characteristic load-bearing capacity in kN, wood strength class 350 kg/m³ char. Gross density. The minimum distances between the connectors and the edges according to EC 5 must be complied with.

Load direction F2/F3												
Connection Timber-Concrete												
Vertical leg connection	Anchor nails Ø 4 x 40 n=41	Anchor nails Ø 4 x 40 n=41	Anchor nails Ø 4 x 50 n=41	Anchor nails Ø 4 x 50 n=41	Anchor nails Ø 4 x 60 n=41	Anchor nails Ø 4 x 60 n=41	ABS Ø 5 x 40 n=41	ABS Ø 5 x 40 n=41	ABS Ø 5 x 50 n=41	ABS Ø 5 x 50 n=41	ABS Ø 5 x 60 n=41	ABS Ø 5 x 60 n=41
	Panelwistec CH Ø 5 x 120 n=6											
Horizontal leg connection	Rock concrete screw Ø 12,5 x 120 n=2	Bolt anchor Ø 12 x 110 n=2	Rock concrete screw Ø 12,5 x 120 n=2	Bolt anchor Ø 12 x 110 n=2	Rock concrete screw Ø 12,5 x 120 n=2	Bolt anchor Ø 12 x 110 n=2	Rock concrete screw Ø 12,5 x 120 n=2	Bolt anchor Ø 12 x 110 n=2	Rock concrete screw Ø 12,5 x 120 n=2	Bolt anchor Ø 12 x 110 n=2	Rock concrete screw Ø 12,5 x 120 n=2	Bolt anchor Ø 12 x 110 n=2
	incl. pressure plate 230 x 70											
Char.-shearing capacity [kN]	30,5	23,4	36,0	23,4	37,2	23,4	41,9	23,4	44,6	23,4	47,6	23,4

The load-bearing capacities were determined based on ETA-19/0020 Characteristic load-bearing capacity in kN, wood strength class 350 kg/m³ char. Gross density. The minimum distances between the connectors and the edges according to EC 5 must be complied with.

Please note: Verify the assumptions made. The stated values, and type and number of joining devices are based on preliminary measurements. Projects are to be dimensioned exclusively by authorised persons in accordance with the State Building Code. As per LBauO, please contact a qualified structural engineer for a paid proof of stability. We will be happy to refer you to someone.

PARTIAL UTILISATION 1

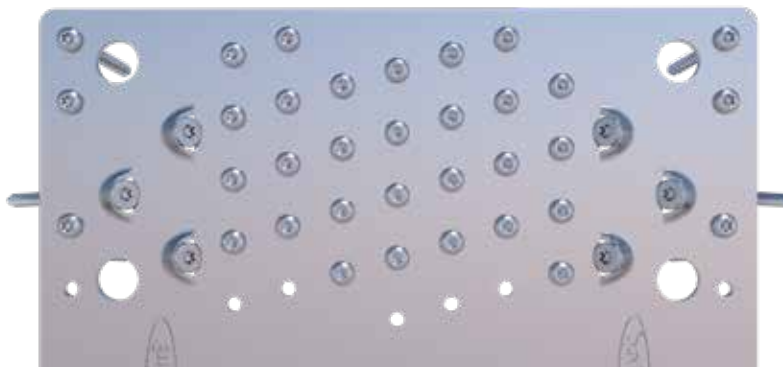

Load direction F2/F3						
Connection Timber-Timber						
Vertical leg connection	Anchor nails Ø 4 x 40 n=34	Anchor nails Ø 4 x 50 n=34	Anchor nails Ø 4 x 60 n=34	ABS Ø 5 x 40 n=34	ABS Ø 5 x 50 n=34	ABS Ø 5x60 n=34
	Paneltwistec CH Ø 5 x 120 n=6					
Horizontal leg connection	Anchor nails Ø 4 x 40 n=34	Anchor nails Ø 4 x 50 n=34	Anchor nails Ø 4 x 60 n=34	ABS Ø 5 x 40 n=34	ABS Ø 5 x 50 n=34	ABS Ø 5 x 60 n=34
	Paneltwistec CH Ø 5 x 120 n=6					
Char.-shearing capacity [kN]	23,9	28,1	29,1	32,7	34,9	37,2
Char. shearing capacity [kN] (use Sonotec SK04)	17,7	20,8	21,5	25,5	27,2	29

Load direction F2/F3												
Connection Timber-Concrete												
Vertical leg connection	Anchor nails Ø 4 x 40 n=34	Anchor nails Ø 4 x 40 n=34	Anchor nails Ø 4 x 50 n=34	Anchor nails Ø 4 x 50 n=34	Anchor nails Ø 4 x 60 n=34	Anchor nails Ø 4 x 60 n=34	ABS Ø 5 x 40 n=34	ABS Ø 5 x 40 n=34	ABS Ø 5 x 50 n=34	ABS Ø 5 x 50 n=34	ABS Ø 5 x 60 n=34	ABS Ø 5 x 60 n=34
	Paneltwistec CH Ø 5 x 120 n=6											
Horizontal leg connection	Rock concrete screw Ø 12,5 x 120 n=2	Bolt anchor Ø 12 x 110 n=2	Rock concrete screw Ø 12,5 x 120 n=2	Bolt anchor Ø 12 x 110 n=2	Rock concrete screw Ø 12,5 x 120 n=2	Bolt anchor Ø 12 x 110 n=2	Rock concrete screw Ø 12,5 x 120 n=2	Bolt anchor Ø 12 x 110 n=2	Rock concrete screw Ø 12,5 x 120 n=2	Bolt anchor Ø 12 x 110 n=2	Rock concrete screw Ø 12,5 x 120 n=2	Bolt anchor Ø 12 x 110 n=2
	incl. pressure plate 230 x 70											
Char.-shearing capacity [kN]	23,9	23,4	28,1	23,4	29,1	23,4	32,7	23,4	34,9	23,4	37,2	23,4

The load-bearing capacities were determined based on ETA-19/0020 Characteristic load-bearing capacity in kN, wood strength class 350 kg/m³ char. Gross density. The minimum distances between the connectors and the edges according to EC 5 must be complied with.

Please note: Verify the assumptions made. The stated values, and type and number of joining devices are based on preliminary measurements. Projects are to be dimensioned exclusively by authorised persons in accordance with the State Building Code. As per LBauO, please contact a qualified structural engineer for a paid proof of stability. We will be happy to refer you to someone.

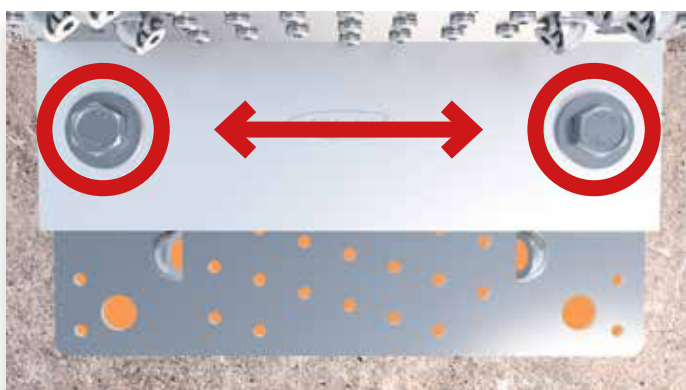

Note
All values given refer to the drilling pattern shown. We recommend using this as it has a considerably higher shear carrying capacity compared to the rear holes.

PARTIAL UTILISATION 2

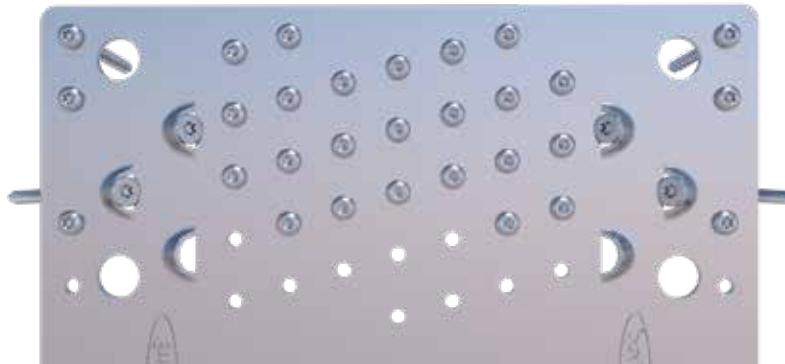

Load direction F2/F3						
Connection Timber-Timber						
Vertical leg connection	Anchor nails Ø 4 x 40 n=29	Anchor nails Ø 4 x 50 n=29	Anchor nails Ø 4 x 60 n=29	Angle-bracket screw Ø 5 x 40 n=29	Angle-bracket screw Ø 5 x 50 n=29	Angle-bracket screw Ø 5 x 60 n=29
	Panelwistec CH Ø 5 x 120 n=4					
Horizontal leg connection	Anchor nails Ø 4 x 40 n=29	Anchor nails Ø 4 x 50 n=29	Anchor nails Ø 4 x 60 n=29	Angle-bracket screw Ø 5 x 40 n=29	Angle-bracket screw Ø 5 x 50 n=29	Angle-bracket screw Ø 5 x 60 n=29
	Panelwistec CH Ø 5 x 120 n=4					
Char. Shear carrying capacity [kN]	19,3	22,8	23,6	26,5	28,3	30,1
Char. Shear carrying capacity [kN] (Use of Sonotec SK04)	14,3	16,9	17,5	20,7	22,1	23,5

Load direction F2/F3												
Connection Timber-Concrete												
Vertical leg connection	Anchor nails Ø 4 x 40 n=29	Anchor nails Ø 4 x 40 n=29	Anchor nails Ø 4 x 50 n=29	Anchor nails Ø 4 x 50 n=29	Anchor nails Ø 4 x 60 n=29	Anchor nails Ø 4 x 60 n=29	Angle-bracket screw Ø 5 x 40 n=29	Angle-bracket screw Ø 5 x 40 n=29	Angle-bracket screw Ø 5 x 50 n=29	Angle-bracket screw Ø 5 x 50 n=29	Angle-bracket screw Ø 5 x 60 n=29	Angle-bracket screw Ø 5 x 60 n=29
	Panelwistec CH Ø 5 x 120 n=4											
Horizontal leg connection	Rock concrete screws Ø 12,5 x 120 n=2	Bolt anchor Ø 12 x 110 n=2	Rock concrete screws Ø 12,5 x 120 n=2	Bolt anchor Ø 12 x 110 n=2	Rock concrete screws Ø 12,5 x 120 n=2	Bolt anchor Ø 12 x 110 n=2	Rock concrete screws Ø 12,5 x 120 n=2	Bolt anchor Ø 12 x 110 n=2	Rock concrete screws Ø 12,5 x 120 n=2	Bolt anchor Ø 12 x 110 n=2	Rock concrete screws Ø 12,5 x 120 n=2	Bolt anchor Ø 12 x 110 n=2
	incl. pressure plate 230 x 70											
Char.-Schertragfähigkeit [kN]	19,3	19,3	22,8	22,8	23,6	23,4	26,5	23,4	28,3	23,4	30,1	23,4

The load-bearing capacities were determined based on ETA-19/0020 Characteristic load-bearing capacity in kN, wood strength class 350 kg/m³ char. Gross density. The minimum distances between the connectors and the edges according to EC 5 must be complied with.

Please note: Verify the assumptions made. The stated values, and type and number of joining devices are based on preliminary measurements. Projects are to be dimensioned exclusively by authorised persons in accordance with the State Building Code. As per LBauO, please contact a qualified structural engineer for a paid proof of stability. We will be happy to refer you to someone.

HB FLAT SHEARING ANGLE

CONNECTOR DEVELOPED FOR MODERN TIMBER CONSTRUCTION TO ABSORB SHEAR FORCES



ADVANTAGES

- For assembly on concrete
- Very high shear load-bearing capacity
- Fewer connectors required
- In combination with the pressure plate, the following tensile forces can be absorbed when fixing in concrete.



DESCRIPTION

The HB flat shearing angle (wood-concrete) is a bracket connector for absorbing shearing forces that was specifically developed for modern timber construction. Its low height means it is ideally suited to use in timber frame construction. The pressure plate allows the occurring loads to be optimally conducted into the concrete.

Suitable for use with:
 Pressure plate (p. 29), Bolt anchor (p. 168)
 Rock concrete screw (p. 76)
 Angle-bracket screw (p. 108),
 Panelwistec (p. 110)
 SonoTec Angular Decoupler (p. 156)

Art. no.	Name	Dimensions [mm] ^{a)}	Material	Material thickness [mm]	PU
954087	HB flat shearing angle	230 x 100 x 70	S250 Galvanised	3	1
954111	Pressure plate Shearing angle	230 x 68	S235 Galvanised	12	1

a) Length x Width x Height



HB flat shearing angle with pressure plate for fixing a wall to the concrete foundation.

HB FLAT SHEARING ANGLE - STATIC VALUES



Load direction F2/F3 ; F4		
Connection Timber-Concrete		
Vertical leg connection	Angle-bracket screw Ø 5 x 25 n=3	
	Paneltwistec CH Ø 5 x 120 n=12	
Horizontal leg connection	Rock concrete screws Ø 12,5 x 120 n=2	Bolt anchor Ø 12 x 110 n=2
	incl. pressure plate 230 x 68 x 12	
Char. Shear carrying capacity F_{23} [kN]	40,0	23,9
Char. bearing capacity F_4 [kN]	40,0	40,0

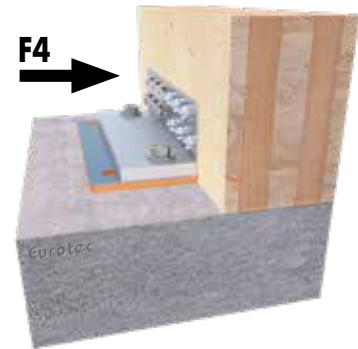

Please note: Verify the assumptions made. The stated values, and type and number of joining devices are based on preliminary measurements. Projects are to be dimensioned exclusively by authorised persons in accordance with the State Building Code. As per LBau0, please contact a qualified structural engineer for a paid proof of stability. We will be happy to refer you to someone.

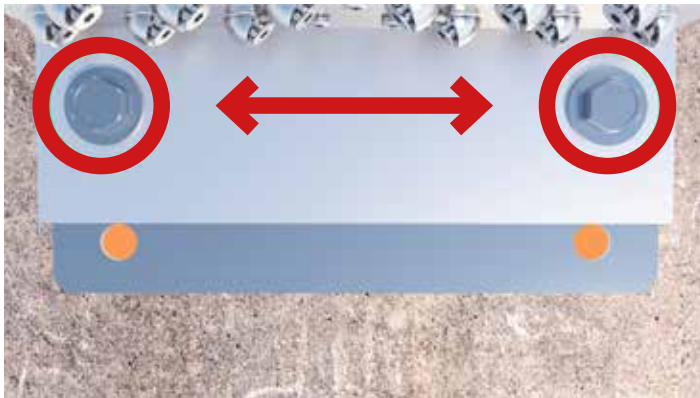

i

Note

All values given refer to the drilling pattern shown. We recommend using this as it has a considerably higher shear carrying capacity compared to the rear holes.

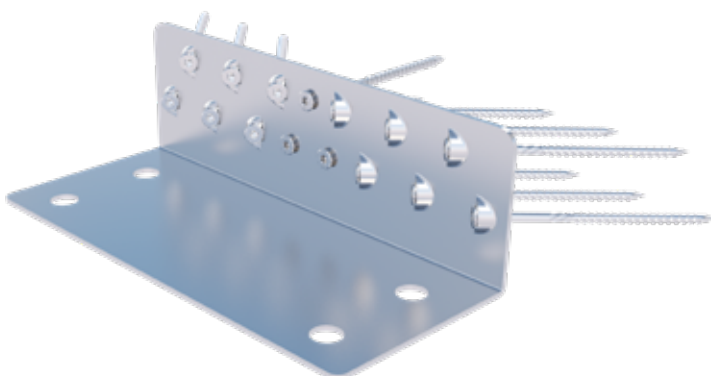

HB flat shearing angle with Paneltwistec CH

HH FLAT SHEARING ANGLE

CONNECTOR DEVELOPED FOR MODERN TIMBER CONSTRUCTION TO ABSORB SHEAR FORCES



ADVANTAGES

- For assembly on timber
- Very high shear load-bearing capacity
- Fewer connectors required
- Especially high tensile forces can be absorbed in combination with the KonstruX

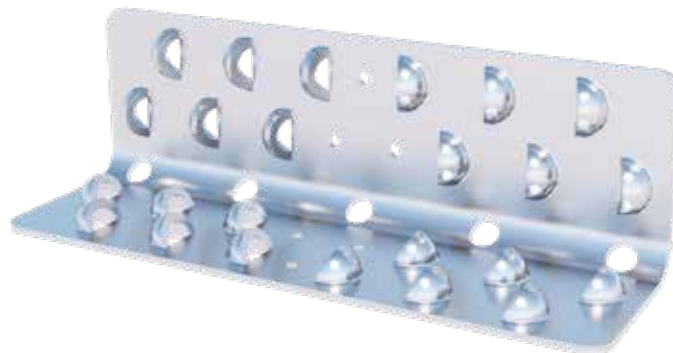

DESCRIPTION

The HH flat shearing angle (wood-wood) is a bracket connector for absorbing shearing forces that was specifically developed for modern timber construction. Its low height means it is ideally suited to use in timber frame construction.

Suitable for use with:
 Paneltwistec (p. 110), Angle-bracket screw (p. 108),
 KonstruX fully threaded screw (p. 80),
 SonoTec Angular Decoupler (p. 156)

Art. no.	Name	Dimensions [mm] ^{a)}	Material	Material thickness [mm]	PU
954088 a) Length x Width	HH flat shearing angle	230 x 70	S250 Galvanised	3	1



HH flat shearing angle for fixing a wall to the wooden floor of the upper level.

HH FLAT SHEARING ANGLE - STATIC VALUES



Load direction F2/F3 ; F4	
Connection Wood-Wood	
Vertical leg connection	ABS Ø 5 x 25 n=3
	Panelwistec CH Ø 5 x 120 n=12
Horizontal leg connection	ABS Ø 5 x 25 n=3
	Panelwistec CH Ø 5 x 120 n=12
Char.-shearing capacity F_{23} [kN]	40,0
Char.-shearing capacity F_{23} [kN] (use SonoTec SK04)	36,0
Char.- load-bearing capacity F_4 [kN]	40,0
Char.- load-bearing capacity F_4 [kN] (use SonoTec SK04)	36,0

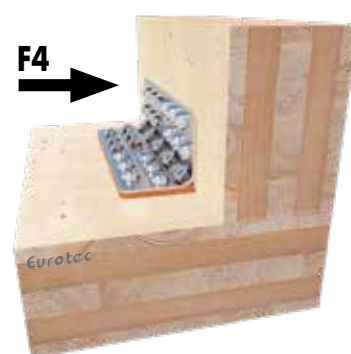

Please note: Verify the assumptions made. The stated values, and type and number of joining devices are based on preliminary measurements. Projects are to be dimensioned exclusively by authorised persons in accordance with the State Building Code. As per LBauO, please contact a qualified structural engineer for a paid proof of stability. We will be happy to refer you to someone.

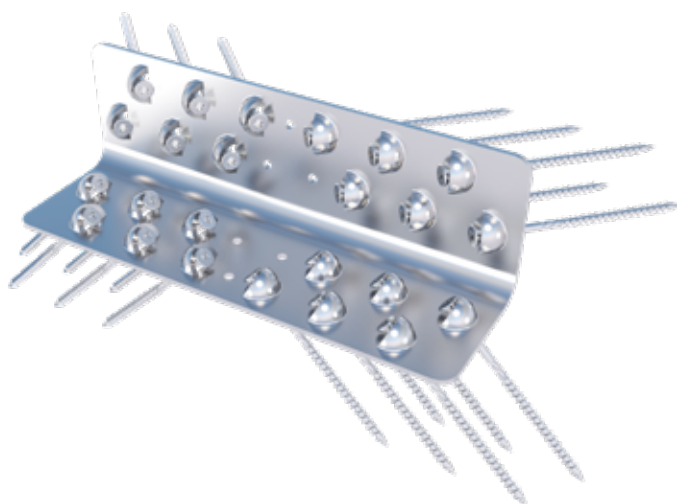

SHEARING PLATE

CONNECTOR DEVELOPED FOR MODERN TIMBER CONSTRUCTION TO ABSORB SHEAR FORCES



ADVANTAGES

- Very high shear load-bearing capacity
- Many different fields of application
- For installation in wood-concrete, and wood-wood connections
- Fewer connectors required

INSTRUCTIONS FOR USE

6 slanted screw connection holes and 41 holes each side, which are optionally intended for angle-bracket screws (ABSs) or anchor nails, are provided for anchoring in wood. Depending on the application, we have provided two additional partial utilisations of the fixing holes which are also available as static-type calculations. Anchoring in concrete is carried out using the holes (Ø 14 mm) provided for this purpose with our Rock concrete screw Ø 12,5 mm or bolt anchors Ø 12 mm.

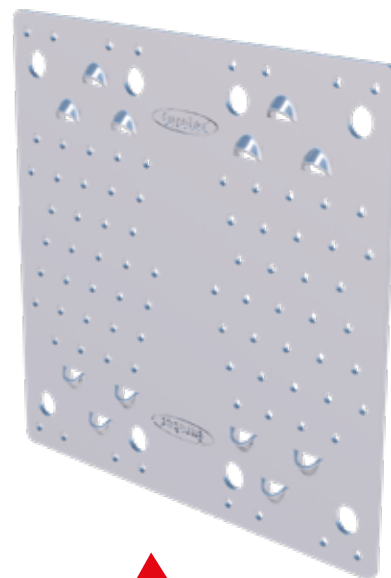

Suitable for use with:
 Bolt anchor (p. 168), Anchor nails (p. 37),
 Panelwistec (p. 110), Angle-bracket screw (p. 108)
 Rock concrete screw (p. 76)

Art. no.	Name	Dimensions [mm]	Material	Material thickness [mm]	PU
954113	Shearing plate	230 x 240	S250 Galvanised	3	1



Shearing plate for fixing two walls together.

SHEARING PLATE - STATIC FULL UTILISATION VALUES

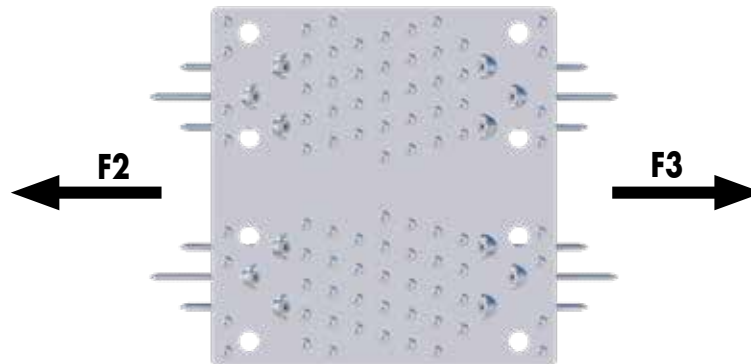

Load direction F2/3								
Timber-Timber	Fixing in the sole plate and solid timber ceiling							Steel
	Joining devices							
	Anchor nails			Angle-bracket screw			Panelwistec CH	
Dimensions [mm]	4 x 40	4 x 50	4 x 60	5 x 40	5 x 50	5 x 60	5 x 120	S250
Quantity (n)	41			41			6	
Char. shearing capacity [kN]	30,5	36	37,2	41,9	44,6	47,6	-	156

Load direction F2/3										
Timber-Concrete	Fixing in the sole plate						Fixing in the concrete ceiling			Steel
	Joining devices									
	Anchor nails			Angle-bracket screw			Panelwistec CH	Rock concrete screws	Bolt anchor	
Dimensions [mm]	4 x 40	4 x 50	4 x 60	5 x 40	5 x 50	5 x 60	5 x 120	Ø 12,5	Ø 12	S250
Quantity (n)	41			41			6	2	2	
Char. shearing capacity [kN]	30,5	36	37,2	41,9	44,6	47,6	-	21,8	12,2	156

The load-bearing capacities were determined on the basis of ETA-19/0020. Characteristic load-bearing capacity in kN, wood strength class 350 kg/m³ char. gross density. The minimum edge distances for joining devices according to EC 5 must be observed.

Please note: Verify the assumptions made. The stated values, and type and number of joining devices are based on preliminary measurements. Projects are to be dimensioned exclusively by authorised persons in accordance with the State Building Code. As per LBauO, please contact a qualified structural engineer for a paid proof of stability. We will be happy to refer you to someone.

Anchor nails
With flat head



Art. no.	Dimensions	Material	PU
200240	4,0 x 40	Galvanised	250
200241	4,0 x 50	Galvanised	250
200242	4,0 x 60	Galvanised	250

Suitable for use with:
Shearing angle (p. 28), Shearing plate (p. 36)
Shearing angle HB flat (p. 32)
Shrearing angle HH flat (p. 34)
Tension strap HB / HH (p. 40, 42)

PARTIAL UTILISATION 1

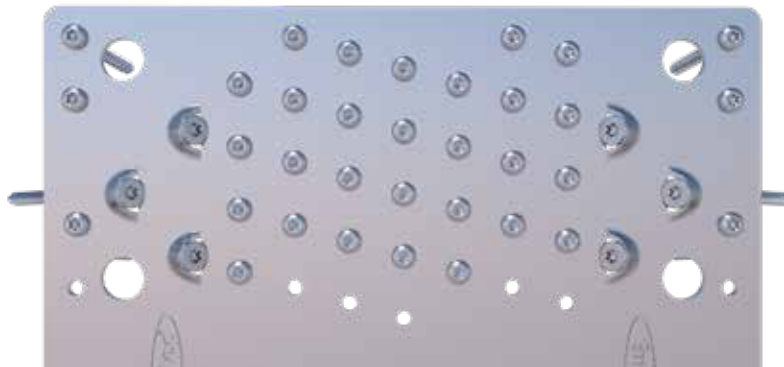

Load direction F2/3									
Timber-Timber	Fixing in the sole plate and solid timber ceiling							Steel	
	Joining devices								
	Anchor nails			Angle-bracket screw			Panelwistec CH		
Dimensions [mm]	4 x 40	4 x 50	4 x 60	5 x 40	5 x 50	5 x 60	5 x 120	S250	
Quantity (n)	34			34			6		
Char. shearing capacity [kN]	23,9	28,1	29,1	32,7	34,9	37,2	-	156	

Load direction F2/3										
Timber-Concrete	Fixing in the sole plate						Fixing in the concrete ceiling			Steel
	Joining devices									
	Anchor nails			Angle-bracket screw			Panelwistec CH	Rock-concrete screws	Bolt anchor	
Dimensions [mm]	4 x 40	4 x 50	4 x 60	5 x 40	5 x 50	5 x 60	5 x 120	Ø 12,5	Ø 12	S250
Quantity (n)	34			34			6	2	2	
Char. shearing capacity [kN]	23,9	28,1	29,1	32,7	34,9	37,2	-	20,5	11,6	156

The load-bearing capacities were determined on the basis of ETA-19/0020. Characteristic load-bearing capacity in kN, wood strength class 350 kg/m³ char. gross density. The minimum edge distances for joining devices according to EC 5 must be observed.

PARTIAL UTILISATION 2

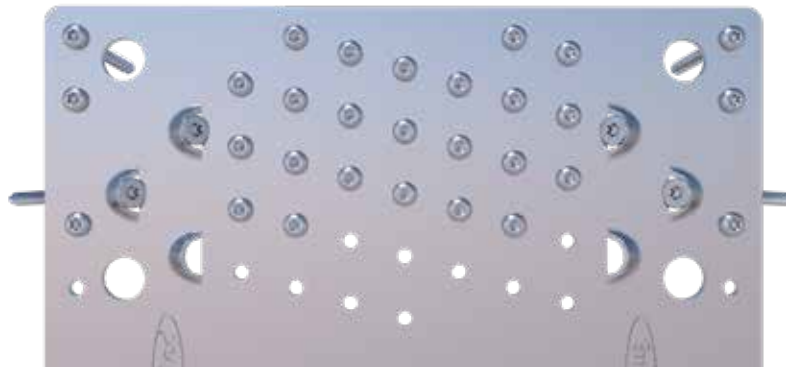

Load direction F2/3									
Timber-Timber	Fixing in the sole plate and solid timber ceiling							Steel	S250
	Joining devices								
	Anchor nails			Angle-bracket screw			Panelwistec CH		
Dimensions [mm]	4 x 40	4 x 50	4 x 60	5 x 40	5 x 50	5 x 60	5 x 120		
Quantity (n)	29			29			4		
Char. shearing capacity [kN]	19,3	22,8	23,6	26,5	28,3	30,1	-	156	

Load direction F2/3										
Timber-Concrete	Fixing in the sole plate						Fixing in the concrete ceiling			Steel
	Joining devices									
	Anchor nails			Angle-bracket screw			Panelwistec CH	Rockconcrete screws	Bolt anchor	
Dimensions [mm]	4 x 40	4 x 50	4 x 60	5 x 40	5 x 50	5 x 60	5 x 120	Ø 12,5	Ø 12	
Quantity (n)	29			29			4	2	2	
Char. shearing capacity [kN]	19,3	22,8	23,6	26,5	28,3	30,1	-	14,4	11,2	

The load-bearing capacities were determined on the basis of ETA-19/0020. Characteristic load-bearing capacity in kN, wood strength class 350 kg/m³ char. gross density. The minimum edge distances for joining devices according to EC 5 must be observed.

Please note: Verify the assumptions made. The stated values, and type and number of joining devices are based on preliminary measurements. Projects are to be dimensioned exclusively by authorised persons in accordance with the State Building Code. As per LBauO, please contact a qualified structural engineer for a paid proof of stability. We will be happy to refer you to someone.

TENSION STRAP HB60 / HB70

CONNECTOR DEVELOPED FOR MODERN TIMBER CONSTRUCTION TO ABSORB TENSILE- AND SHEAR FORCES.



ADVANTAGES

- Very high shear load-bearing capacity
- Many different fields of application
- For installation in wood and concrete
- Fewer connectors required
- Can be used with or without a sill plate

INSTRUCTIONS FOR USE

Anchoring in wood is carried out using 5 x 120 mm countersunk-head screws at an angle of 45°. Thanks to the holes specially provided for this purpose, which also serve as screw guides, a non-positive connection is created between the screw head and the tension strap. The anchoring in the concrete is achieved through the holes provided (Ø 14mm) with our Rock concrete screw or Bolt anchor. The minimum distance of the concrete connector to the top edge of the foundation is 65mm. Tension straps HH70 (p. 42) and HB70 have two Ø 5 mm holes for 90° screw connection.

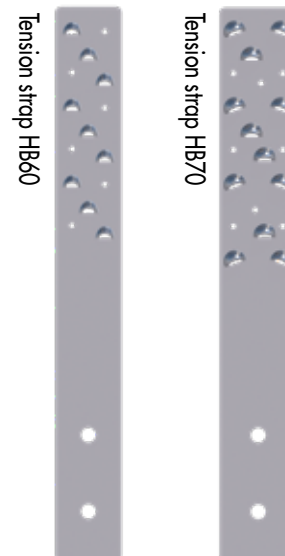

Suitable for use with:
 Panelwistec CH (p. 110), Bolt anchor (p. 168)
 Anchor nails (p. 37), Rock concrete screw (p. 76)
 Angle-bracket screw (p. 108)

Art. no.	Name	Dimensions [mm]	Material	Material thickness [mm]	PU
954095	Tension strap HB60	506 x 60	S250 Galvanised	3	1
954097	Tension strap HB70	506 x 70	S250 Galvanised	3	1

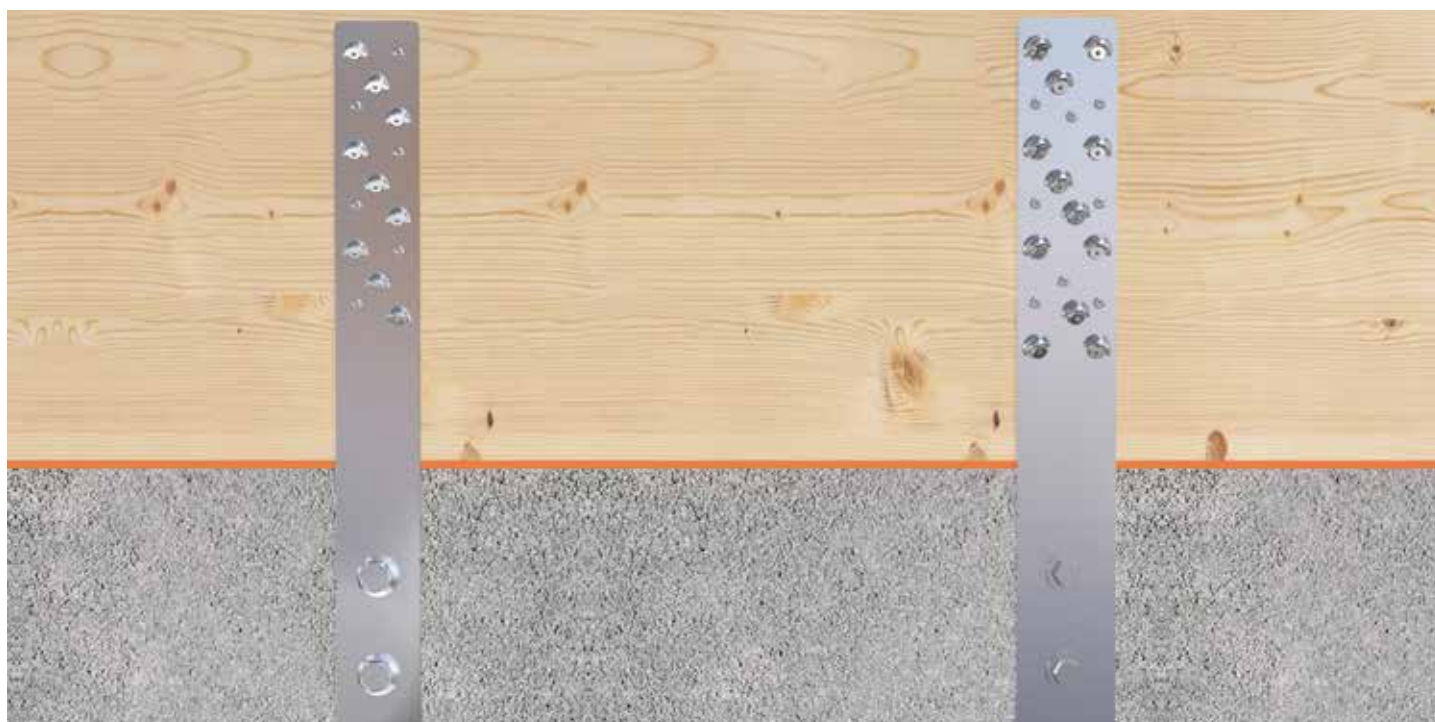

Tension strap HB for fastening a wall to the foundation.

TENSION STRAP HB60 - STATIC VALUES



Load direction F1

Connection Timber-Concrete

Wood side connection	Panelhwstec CH Ø 5 x 120 n=9				Anchor nails Ø 4 x 40 n=6				Anchor nails Ø 4 x 50 n=6				Anchor nails Ø 4 x 60 n=6	
Concrete side connection	Rock concrete screws Ø 12,5 x 120 n=1	Rock concrete screws Ø 12,5 x 120 n=2	Bolt anchor Ø 12 x 110 n=1	Bolt anchor Ø 12 x 110 n=2	Rock concrete screws Ø 12,5 x 120 n=1	Rock concrete screws Ø 12,5 x 120 n=2	Bolt anchor Ø 12 x 110 n=1	Bolt anchor Ø 12 x 110 n=2	Rock concrete screws Ø 12,5 x 120 n=1	Rock concrete screws Ø 12,5 x 120 n=2	Bolt anchor Ø 12 x 110 n=1	Bolt anchor Ø 12 x 110 n=2	Rock concrete screws Ø 12,5 x 120 n=1	Rock concrete screws Ø 12,5 x 120 n=2
Char. Shear carrying capacity [kN]	20,8*	20,8*	12,6	20,8*	9,3	9,3	9,3	9,3	11,0	11,0	11,0	11,0	11,4	11,4

Load direction F1

Connection Timber-Concrete

Wood side connection	Anchor nails Ø 4 x 60 n=6		Angle-bracket screw Ø 5 x 40 n=6				Angle-bracket screw Ø 5 x 50 n=6				Angle-bracket screw Ø 5 x 60 n=6			
Concrete side connection	Bolt anchor Ø 12 x 110 n=1	Bolt anchor Ø 12 x 110 n=2	Rock concrete screws Ø 12,5 x 120 n=1	Rock concrete screws Ø 12,5 x 120 n=2	Bolt anchor Ø 12 x 110 n=1	Bolt anchor Ø 12 x 110 n=2	Rock concrete screws Ø 12,5 x 120 n=1	Rock concrete screws Ø 12,5 x 120 n=2	Bolt anchor Ø 12 x 110 n=1	Bolt anchor Ø 12 x 110 n=2	Rock concrete screws Ø 12,5 x 120 n=1	Rock concrete screws Ø 12,5 x 120 n=2	Bolt anchor Ø 12 x 110 n=1	Bolt anchor Ø 12 x 110 n=2
Char. Shear carrying capacity [kN]	11,4	11,4	10,9	10,9	10,9	10,9	12,0	12,0	12,0	12,0	13,1	13,1	12,6	13,1

* Concrete edge breakout for cracked concrete

The load-bearing capacities were determined based on ETA-19/0020 Characteristic load-bearing capacity in kN, wood strength class 350 kg/m³ char. Gross density. The minimum distances between the connectors and the edges according to EC 5 must be complied with.

Please note: Verify the assumptions made. The stated values, and type and number of joining devices are based on preliminary measurements. Projects are to be dimensioned exclusively by authorised persons in accordance with the State Building Code. As per LBauO, please contact a qualified structural engineer for a paid proof of stability. We will be happy to refer you to someone.

TENSION STRAP HB70 – STATIC VALUES



Load direction F1

Connection Timber-Concrete

Wood side connection	Panelhwstec CH Ø 5 x 120 n=12				Anchor nails Ø 4 x 40 n=8				Anchor nails Ø 4 x 50 n=8				Anchor nails Ø 4 x 60 n=8	
Concrete side connection	Rock concrete screws Ø 12,5 x 120 n=1	Rock concrete screws Ø 12,5 x 120 n=2	Bolt anchor Ø 12 x 110 n=1	Bolt anchor Ø 12 x 110 n=2	Rock concrete screws Ø 12,5 x 120 n=1	Rock concrete screws Ø 12,5 x 120 n=2	Bolt anchor Ø 12 x 110 n=1	Bolt anchor Ø 12 x 110 n=2	Rock concrete screws Ø 12,5 x 120 n=1	Rock concrete screws Ø 12,5 x 120 n=2	Bolt anchor Ø 12 x 110 n=1	Bolt anchor Ø 12 x 110 n=2	Rock concrete screws Ø 12,5 x 120 n=1	Rock concrete screws Ø 12,5 x 120 n=2
Char. Shear carrying capacity [kN]	20,8*	20,8*	12,6	20,8*	12,5	12,5	12,5	12,5	14,7	14,7	12,6	14,7	15,2	15,2

Load direction F1

Connection Timber-Concrete

Wood side connection	Anchor nails Ø 4 x 60 n=8		Angle-bracket screw Ø 5 x 40 n=8				Angle-bracket screw Ø 5 x 50 n=8				Angle-bracket screw Ø 5 x 60 n=8			
Concrete side connection	Bolt anchor Ø 12 x 110 n=1	Bolt anchor Ø 12 x 110 n=2	Rock concrete screws Ø 12,5 x 120 n=1	Rock concrete screws Ø 12,5 x 120 n=2	Bolt anchor Ø 12 x 110 n=1	Bolt anchor Ø 12 x 110 n=2	Rock concrete screws Ø 12,5 x 120 n=1	Rock concrete screws Ø 12,5 x 120 n=2	Bolt anchor Ø 12 x 110 n=1	Bolt anchor Ø 12 x 110 n=2	Rock concrete screws Ø 12,5 x 120 n=1	Rock concrete screws Ø 12,5 x 120 n=2	Bolt anchor Ø 12 x 110 n=1	Bolt anchor Ø 12 x 110 n=2
Char. Shear carrying capacity [kN]	12,6	15,2	17,2	17,1	12,6	17,1	18,2	18,2	12,6	18,2	19,0	19,0	12,6	19,0

* Concrete edge breakout for cracked concrete

The load-bearing capacities were determined based on ETA-19/0020 Characteristic load-bearing capacity in kN, wood strength class 350 kg/m³ char. Gross density. The minimum distances between the connectors and the edges according to EC 5 must be complied with.

Please note: Verify the assumptions made. The stated values, and type and number of joining devices are based on preliminary measurements. Projects are to be dimensioned exclusively by authorised persons in accordance with the State Building Code. As per LBauO, please contact a qualified structural engineer for a paid proof of stability. We will be happy to refer you to someone.

TENSION STRAP HH60/HH70

FOR ABSORBING TENSILE FORCES AND TENSILE AND SHEARING FORCES DEVELOPED FOR MODERN TIMBER CONSTRUCTION



ADVANTAGES

- Many different fields of application
- For installation in wood and concrete
- Very high shear load-bearing capacity thanks to a new fixing concept
- Fewer connectors required
- Thanks to its angled hole pattern, the tension strap can also absorb shear forces.
- Inter-storey connector

INSTRUCTIONS FOR USE

The Tension strap HH60 with its width of 60 mm is perfect for conventional timber frame construction, whereas the Tension strap HH70 with a width of 70 mm and its angled screw pattern was specially developed for solid wood construction. Anchoring in wood is carried out using 5 x 120 mm countersunk-head screws at an angle of 45°. A forcefit connection is created between the screw head and the tension strap, thanks to the holes specially provided for this purpose, which also serve as screw guides. The Tension strap HH70 has two additional holes Ø 5 mm which are intended for 90° screw connection.

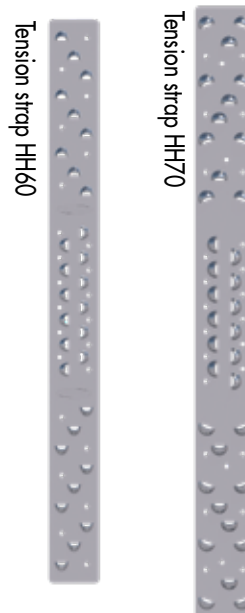

Suitable for use with:
 Panelwistec CH (p. 110)
 Angle-bracket screw (p. 108),
 Anchor nails (p. 37)

Properties	HH60	HH70
Min. Wall/frame width:	60 mm	120 mm
Max. Ceiling thickness:	240 mm	260 mm

Art. no.	Name	Dimensions [mm]	Material	Material thickness [mm]	PU
954096	Tension strap HH60	680 x 60	S250 Galvanised	3	1
954098	Tension strap HH70	740 x 70	S250 Galvanised	3	1



Tension straps HH60/HH70 for fastening wall- and ceiling elements.

TENSION STRAP HH60 - STATIC VALUES



Load direction F1								
Connection Timber-Timber								
Leg connection 1	Panelwistec CH Ø 5 x 120 n= 9	Anchor nails Ø 4 x 40 n=6	Anchor nails Ø 4 x 50 n=6	Anchor nails Ø 4 x 60 n=6	Angle-bracket screw Ø 5 x 40 n=6	Angle-bracket screw Ø 5 x 50 n=6	Angle-bracket screw Ø 5 x 60 n=6	Steel S250
Leg connection 2	Panelwistec CH Ø 5 x 120 n= 9	Anchor nails Ø 4 x 40 n=6	Anchor nails Ø 4 x 50 n=6	Anchor nails Ø 4 x 60 n=6	Angle-bracket screw Ø 5 x 40 n=6	Angle-bracket screw Ø 5 x 50 n=6	Angle-bracket screw Ø 5 x 60 n=6	
Char. tensile capacity [kN]	27	9,4	11	11,4	10,9	12	13,1	28,5

The load-bearing capacities were determined based on ETA-19/0020 Characteristic load-bearing capacity in kN, wood strength class 350 kg/m³ char. Gross density. The minimum distances between the connectors and the edges according to EC 5 must be complied with.

Please note: Verify the assumptions made. The stated values, and type and number of joining devices are based on preliminary measurements. Projects are to be dimensioned exclusively by authorised persons in accordance with the State Building Code. As per LBauO, please contact a qualified structural engineer for a paid proof of stability. We will be happy to refer you to someone.

TENSION STRAP HH70 - STATIC VALUES



Load direction F1								
Connection Timber-Timber								
Leg connection 1	Panelwistec CH Ø 5 x 120 n= 12	Anchor nails Ø 4 x 40 n=8	Anchor nails Ø 4 x 50 n=8	Anchor nails Ø 4 x 60 n=8	Angle-bracket screw Ø 5 x 40 n=8	Angle-bracket screw Ø 5 x 50 n=8	Angle-bracket screw Ø 5 x 60 n=8	Steel S250
Leg connection 2	Panelwistec CH Ø 5 x 120 n= 12	Anchor nails Ø 4 x 40 n=8	Anchor nails Ø 4 x 50 n=8	Anchor nails Ø 4 x 60 n=8	Angle-bracket screw Ø 5 x 40 n=8	Angle-bracket screw Ø 5 x 50 n=8	Angle-bracket screw Ø 5 x 60 n=8	
Char. tensile capacity [kN]	35	12,5	14,7	15,2	17,1	18,2	19,4	37,4

The load-bearing capacities were determined based on ETA-19/0020 Characteristic load-bearing capacity in kN, wood strength class 350 kg/m³ char. Gross density. The minimum distances between the connectors and the edges according to EC5 must be complied with.

Please note: Verify the assumptions made. The stated values, and type and number of joining devices are based on preliminary measurements. Projects are to be dimensioned exclusively by authorised persons in accordance with the State Building Code. As per LBauO, please contact a qualified structural engineer for a paid proof of stability. We will be happy to refer you to someone.

SHEAR WALL CONNECTOR

FOR THE COMPENSATION OF UNEVENNESS IN CONSTRUCTION ELEMENTS

NEW
to our product range

ADVANTAGES

- Allows high shear force transmission between the wall elements
- Compensates for unevenness between building elements
- Does not protrude from the wall

INSTRUCTIONS FOR USE

To install the shear wall connector, first cut a groove in each wall at the same height. The shear wall connector is then inserted into the milling and fixed with two screws. The flatness of the connector helps compensate for slight differences in height between the walls. The screw connection also pulls both walls horizontally to the connector, thus straightening out slight unevenness here as well.



Suitable for use with:
KonstruX ST CH Ø 8,0 mm



Scope of delivery includes screws

Art. no.	Name	Dimensions [mm] ^{a)}	PU*
On request	Shear Wall Connector	100 x 19 x 80	On request

a) Width x Height x Depth



Shear wall connector for fastening two walls together.

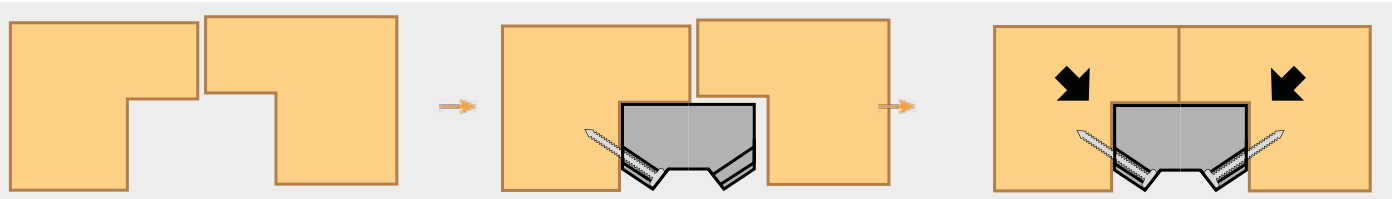

Unevenness compensation through screws and edges



ASSEMBLY CONNECTOR

FOR CONNECTING TWO TIMBER CONSTRUCTION ELEMENTS IN SYSTEMS BUILDING

ADVANTAGES

- Can be used regardless of weather conditions
- Easy assembly
- Quick and easy element positioning

DESCRIPTION

The Eurotec assembly connector consists of two individual components that interlock during assembly. It serves as a preparatory element in system construction.

INSTRUCTIONS FOR USE

We recommend our Paneltwistec AG CH 6 x 80 mm for the use of the assembly connector. It is flush-mounted in a groove positioned at any chosen location on the construction elements. Once the elements have been inserted, the assembly connector is hidden inside the wall. The assembly connector must have a screw inserted in every screw hole. Our assembly connector is designed purely for guidance purposes. It cannot be used to absorb forces.

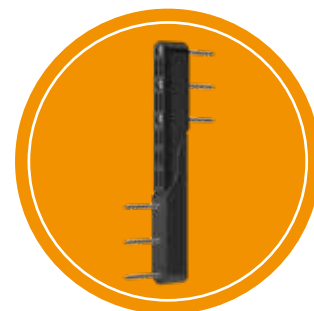

Art. no.	Name	Dimensions [mm] ^{a)}	PU*
800272	Assembly connector	32,7 x 175 x 29,7	50

a) Height x Length x Width
*incl. 150 screws per PU

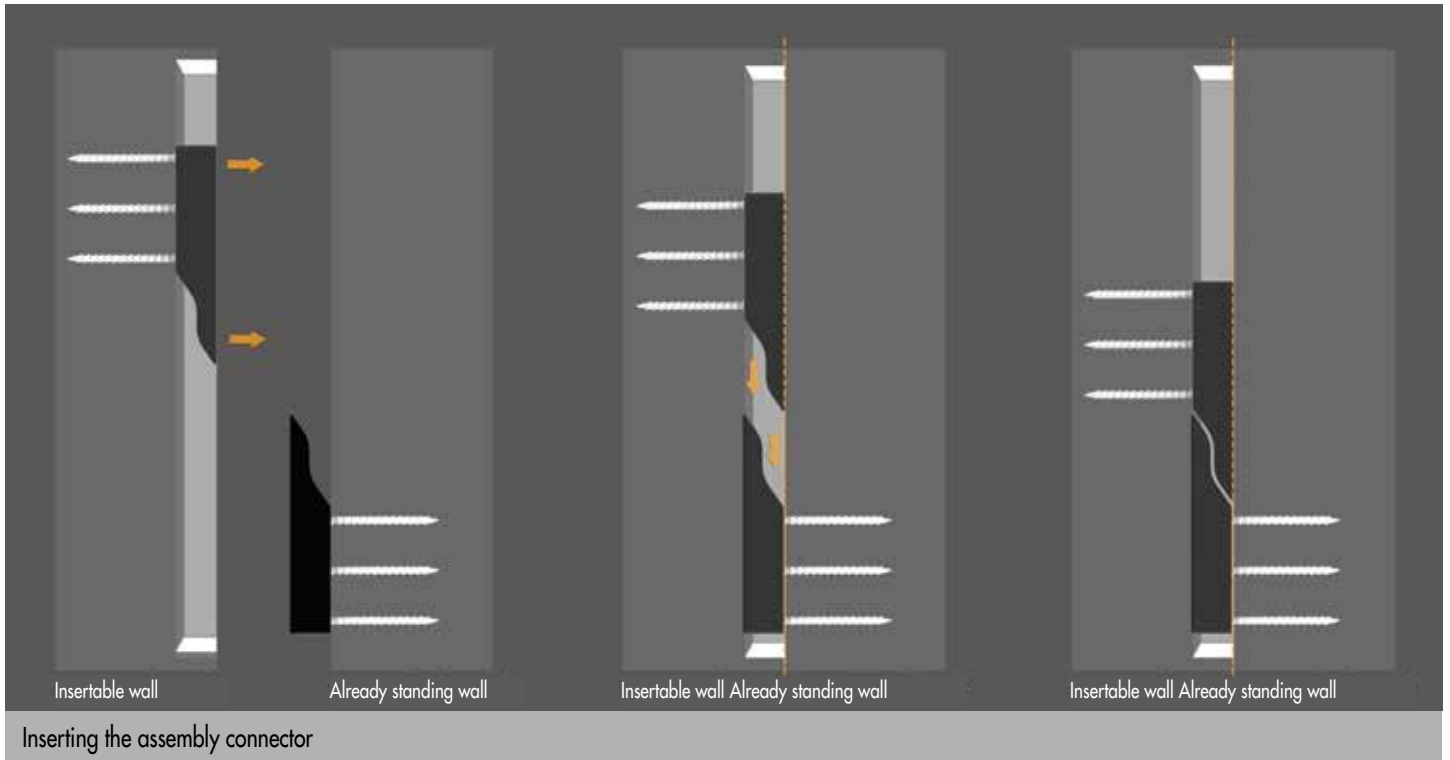

Assembly connector for mounting a wall to a second, already standing wall.

**Note**

The assembly connector is not a connector that should be exposed to large, permanent load - it is only a mounting tool!

MAGNUS HOOK CONNECTOR

TIMBER CONNECTOR FOR MAIN-SECONDARY BEAM JOINTS



ADVANTAGES

- Easy assembly
- High level of prefabrication
- Suitable for high joints
- Visible and hidden loads
- Milling cutter and milling and assembly jig available
- ECS calculation software for free preliminary calculation



INSTRUCTIONS FOR USE

The Magnus should always be fully unscrewed to ensure an easy and safe installation. Whether surface-mounted or recessed, the milling and mounting jig shows the connector where to fit. Sides and end grain surfaces must be flat to avoid any deformation of the connector during the assembly..

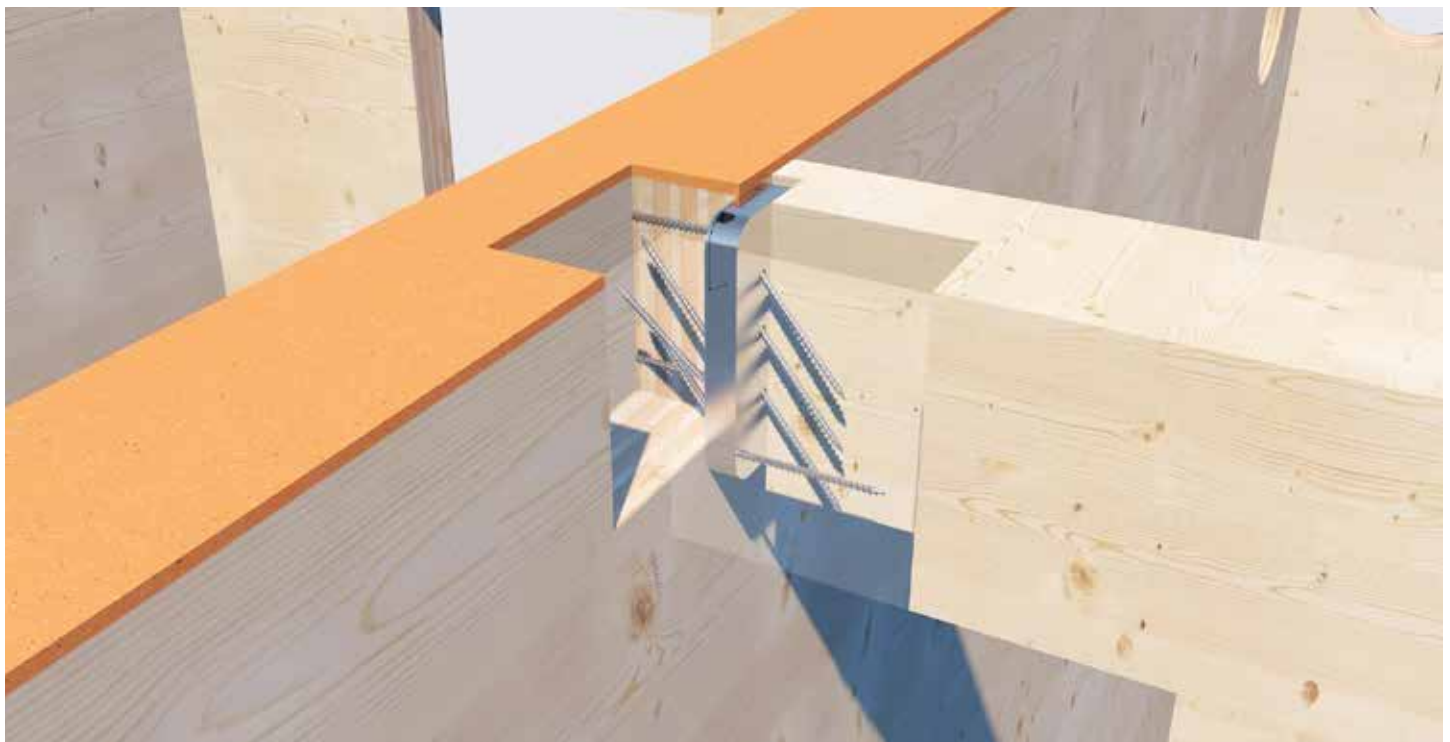

Magnus hook connector for mounting a beam on a wall.

- 1** Insert 90° fully threaded screws and fix Magnus to the wood

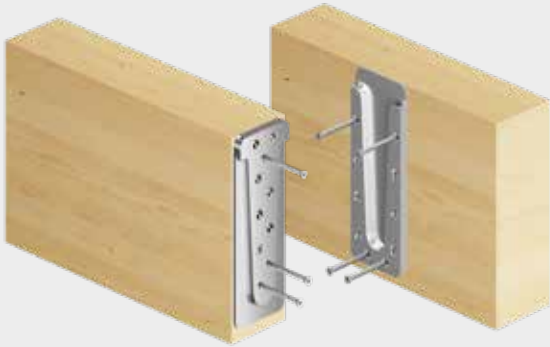

- 2** Insert 45° screws

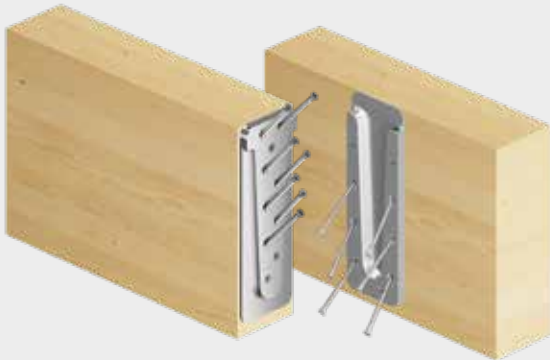

- 3** Mount the secondary beam on the main beam; use fixing screws to secure the joint against lifting out

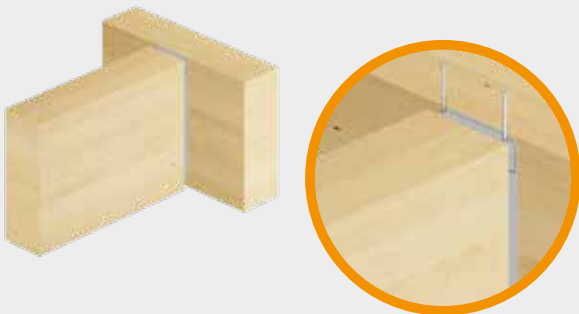

- 4** Joint complete



Connector



Fixing screws



Fully threaded screws

OVERVIEW OF MAGNUS HOOK CONNECTORS

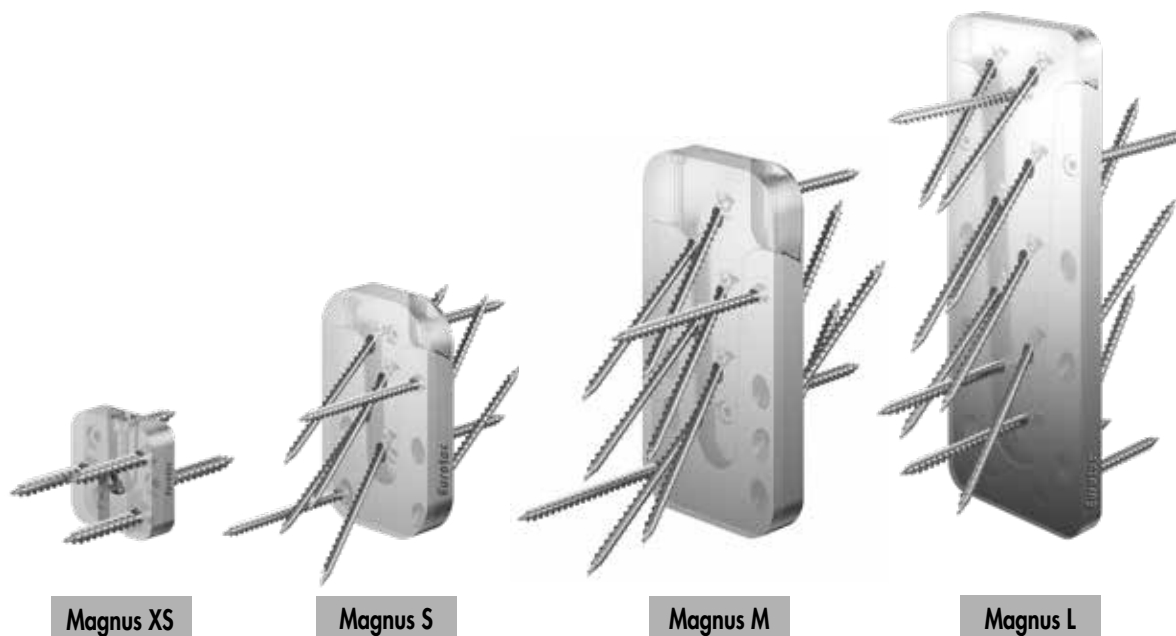

Magnus XS

Magnus S

Magnus M

Magnus L

Art. no.	Name	Dimensions		PU*	Fully threaded screws ^{b)}		Fixing screws ^{b)}		Main beam		Secondary beam surface-mounted		Secondary beam flush-mounted				characteristic load-bearing capacity Fr _k ^{e)}			
		W x H x D ^{a)}			Dimension [mm]	n _{per connector}	Dimension [mm]	n _{per connector}	min. W _{MB} [mm]	min. H _{MB} [mm]	min. W _{SB} [mm]	min. H _{SB} [mm]	min. W _{SB} ^{c)} [mm]	min. H _{SB} [mm]	W _F [mm]	D _M ^{d)} [mm]	F _{1,Rk} [kN]	F _{2,Rk} [kN]	F _{3,Rk} [kN]	F _{4,Rk} [kN]
		[mm]	[mm]																	
944874	Magnus XS 30 x 30	30 x 30 x 9	20	4,0 x 30	6	4,2 x 26	1	40	40	40	40	40	40	30	9	1,2	1,57	1,70	1,19	
944875	Magnus S 50 x 60	50 x 60 x 13	10	4,0 x 60	8	4,2 x 26	2	60	80	60	80	80	80	50	13	3,73	7,25	5,00	1,92	
944876	Magnus S 50 x 80	50 x 80 x 13	10	4,0 x 60	12	4,2 x 26	2	60	100	60	100	80	100	50	13	3,73	14,50	5,00	2,80	
944877	Magnus S 50 x 100	50 x 100 x 13	10	4,0 x 60	18	4,2 x 26	2	60	120	60	120	80	120	50	13	7,46	21,75	5,00	4,41	
944878	Magnus M 70 x 120	70 x 120 x 17	10	5,0 x 80	13	4,8 x 60	2	80	140	80	140	100	140	70	17	5,49	21,34	13,00	5,17	
944879	Magnus M 70 x 140	70 x 140 x 17	10	5,0 x 80	16	4,8 x 60	2	80	160	80	160	100	160	70	17	5,49	32,00	13,00	6,09	
944880	Magnus M 70 x 160	70 x 160 x 17	10	5,0 x 80	21	4,8 x 60	2	80	180	80	180	100	180	70	17	10,98	37,34	13,00	8,27	
944881	Magnus M 70 x 180	70 x 180 x 17	10	5,0 x 80	24	4,8 x 60	2	80	200	80	200	100	200	70	17	10,98	42,67	13,00	9,32	
944882	Magnus L 110 x 220	110 x 220 x 19	4	8,0 x 120	13	4,8 x 60	2	120	240	120	240	140	240	110	19	9,29	36,10	23,00	13,96	
944883	Magnus L 110 x 260	110 x 260 x 19	4	8,0 x 120	17	4,8 x 60	2	120	280	120	280	140	280	110	19	13,93	45,13	23,00	17,98	
944884	Magnus L 110 x 300	110 x 300 x 19	4	8,0 x 120	20	4,8 x 60	2	120	320	120	320	140	320	110	19	13,93	54,15	23,00	20,56	
944887	Magnus L 110 x 340	110 x 340 x 19	4	8,0 x 120	22	4,8 x 60	2	120	360	120	360	140	360	110	19	13,93	63,18	23,00	24,67	
944888	Magnus L 110 x 380	110 x 380 x 19	4	8,0 x 120	25	4,8 x 60	2	120	400	120	400	140	400	110	19	9,29	72,20	23,00	26,96	
944889	Magnus L 110 x 580	110 x 580 x 19	4	8,0 x 120	38	4,8 x 60	2	120	600	120	600	140	600	110	19	9,29	126,35	23,00	43,29	

* 1 connector consists of 2 individual parts

a) D= assembly thickness

b) Included in delivery

c) Recommended minimum width of the secondary beam with the connector flush-mounted

d) To make installation easier, it is advantageous to reduce the milling depth slightly, especially for larger wood dimensions.

e) Both beams softwood with a gross density of ρ_k= 380 kg/m³.

The specified characteristic values of the load-bearing capacity Fr_k apply to the specified timber cross-sections, centred force application along the respective beam axis as well as connector installation flush with the top edge of the main and secondary beams.

Calculation according to ETA 15/0761. All mechanical values provided should be viewed as subject to the assumptions that have been made and represent example calculations.

All values are calculated minimum values and are subject to typographical and printing errors.

The characteristic values of the load-bearing capacity Fr_k should not be treated as equivalent to the max. possible load (the max. force). The characteristic values of the load-bearing capacity Fr_k should be reduced to the design values Fr_d in terms of the service class and the load duration class: Fr_d= Fr_k x k_{mod} / γ_M.

Please note: These are planning aids. Projects must only be calculated by authorised persons.

INSTALLATION ACCESSORIES

Milling and assembly jig

For Magnus hook connector



Art. no.	Suitable for	PU
944867	Magnus XS	1
944894	Magnus S	1
944895	Magnus M	1
944870	Magnus L 220/260/300	1
944903	Magnus L 340/380/420	1
944904	Magnus L 460/500/540/580	1

DESCRIPTION

- Insertion aid for surface-mounted installation
- Milling jig for flush-mounted installation

Milling cutter

For Magnus hook connector



Art. no.	Suitable for	Shaft diameter [mm]	PU
944936	Magnus XS	6,35	1
29686	Magnus S	8	1
29696	Magnus M und L	8	1

THE FOLLOWING MUST BE OBSERVED IN THE EVENT OF FLUSH-MOUNTED INSTALLATION IN THE SECONDARY BEAM

- The beam's minimum width must be increased so that there is enough surrounding wood remaining at the side for the milling work
- The beam must be milled out at full height

THE FOLLOWING MUST BE OBSERVED IN THE EVENT OF FLUSH-MOUNTED INSTALLATION IN THE MAIN BEAM

- The main beam's load-bearing cross-section is reduced by the connector's assembly thickness
- The beam's minimum width must be adjusted (screw length)

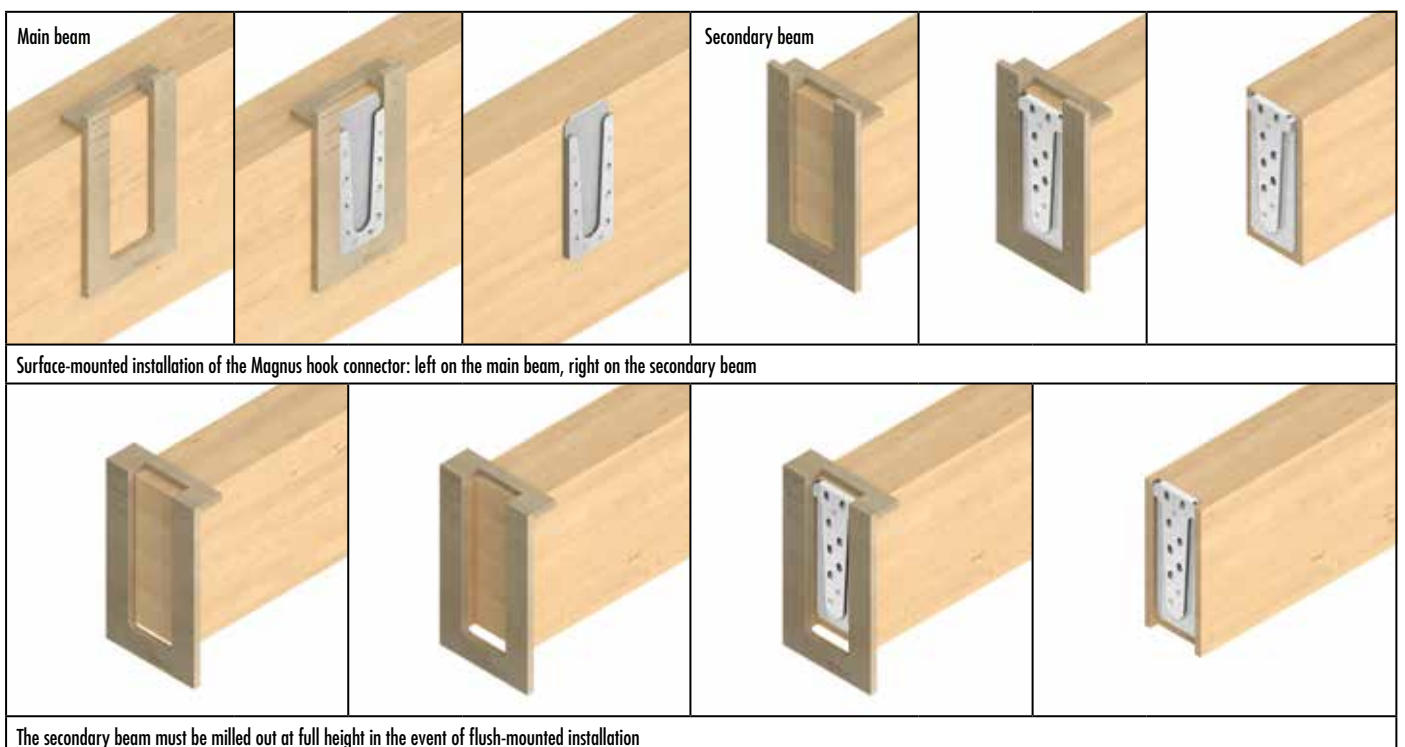

MAGNUS XS 30 X 30

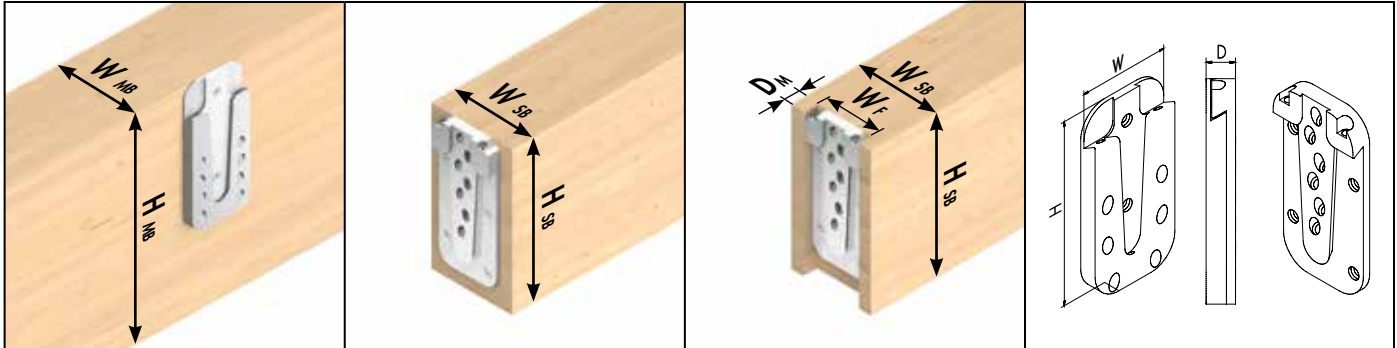

Symbolic illustrations: f.l.t.r. Main beam, secondary beam surface-mounted, secondary beam flush-mounted, connector dimensions

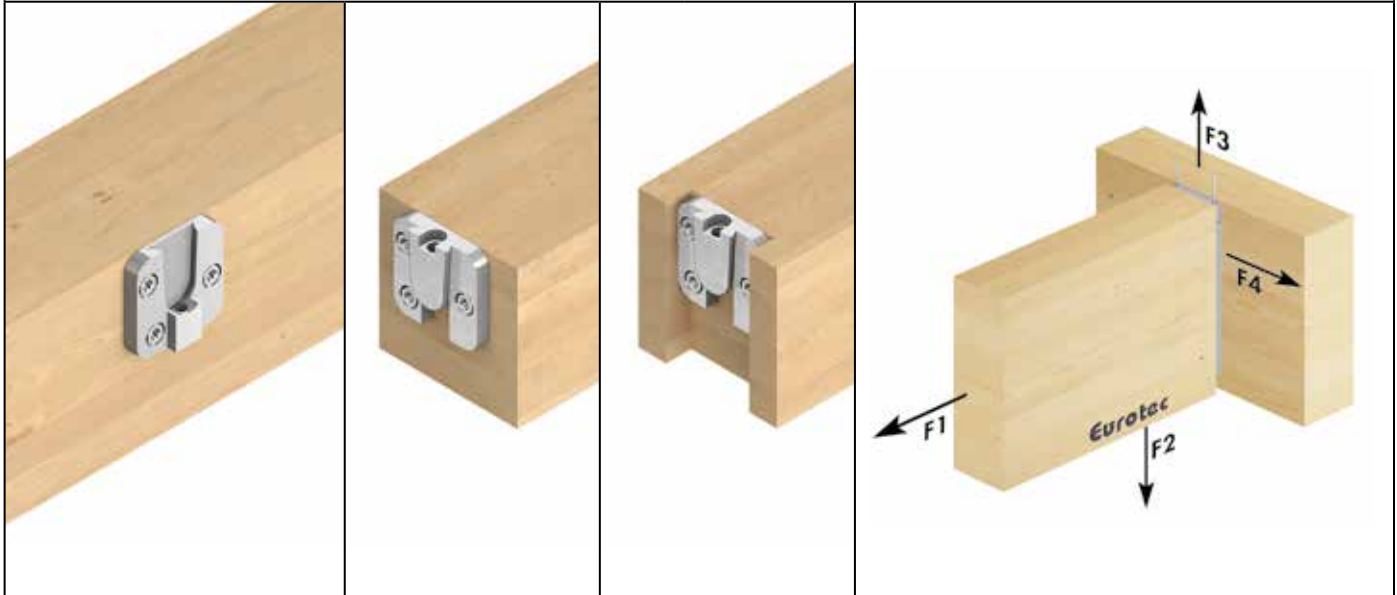

Art. no.	Name	Dimensions		PU*	Fully threaded screws ^{b)}						Fixing screws ^{b)}	
		W x H x D ^{a)}			Dimensions	n _{total}	In the main beam		In the secondary beam		Dimensions	n
		[mm]					[mm]	n _{total}	90°	45°		
944874	Magnus XS 30 x 30	30	30 x 9	20	4,0 x 30	6	3	-	3	-	4,2 x 26	1

* 1 connector consists of 2 individual parts

a) D= assembly thickness

b) Included in delivery

Art. no.	Name	Dimensions		Main beam		Secondary beam surface-mounted		Secondary beam flush-mounted			characteristic load-bearing capacity FR _k ^{d)}				
		W x H x D ^{a)}		min. W _{MB}	min. H _{MB}	min. W _{SB}	min. H _{SB}	min. W _{SB} ^{b)}	min. H _{SB}	W _M	D _M ^{c)}	F _{1,Rk}	F _{2,Rk}	F _{3,Rk}	F _{4,Rk}
		[mm]		[mm]	[mm]	[mm]	[mm]	[mm]	[mm]	[mm]	[mm]	[kN]	[kN]	[kN]	[kN]
944874	Magnus XS 30 x 30	30	30 x 9	40	40	40	40	40	40	30	9	1,12	1,57	1,70	1,19

a) D= assembly thickness

b) Included in delivery

c) Recommended minimum width of the secondary beam with the connector flush-mounted

d) To make installation easier, it is advantageous to reduce the milling depth slightly, especially for larger wood dimensions.

e) Both beams softwood with a gross density of ρ_k= 380 kg/m³.

The specified characteristic values of the load-bearing capacity FR_k apply to the specified timber cross-sections, centred force application along the respective beam axis as well as connector installation flush with the top edge of the main and secondary beams.

Calculation according to ETA 15/0761. All mechanical values provided should be viewed as subject to the assumptions that have been made and represent example calculations.

All values are calculated minimum values and are subject to typographical and printing errors.

The characteristic values of the load-bearing capacity FR_k should not be treated as equivalent to the max. possible load (the max. force). The characteristic values of the load-bearing capacity FR_k should be reduced to the design values FR_d in terms of the

service class and the load duration class: FR_d= FR_k x k_{mod} / γ_M.

Please note: These are planning aids. Projects must only be calculated by authorised persons.

MAGNUS S 50 X 60

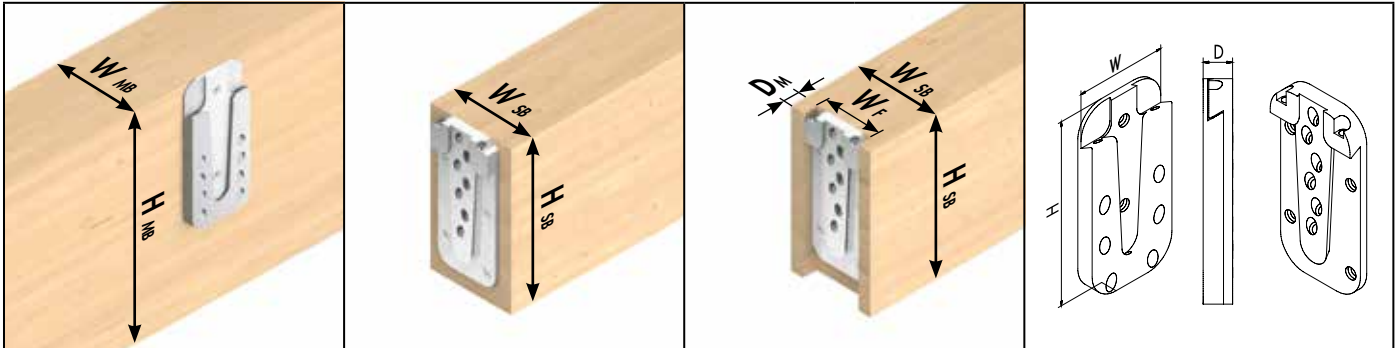

Symbolic illustrations: f.l.t.r. Main beam, secondary beam surface-mounted, secondary beam flush-mounted, connector dimensions

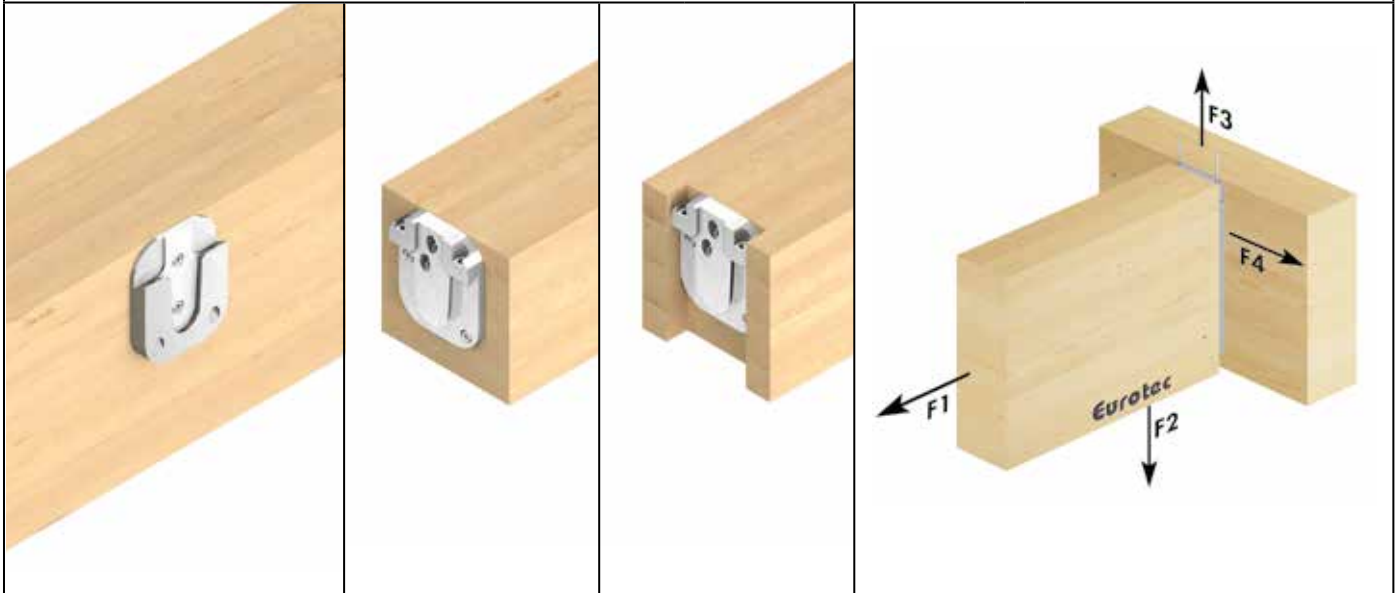

Art. no.	Name	Dimensions W x H x D ^{a)} [mm]	PU*	Fully threaded screws ^{b)}						Fixing screws ^{b)}	
				Dimensions [mm]	n ^{total}	In the main beam		In the secondary beam		Dimensions [mm]	n
						n90°	n45°	n90°	n45°		
944875	Magnus S 50 x 60	50 x 60 x 13	10	4,0 x 60	8	2	2	2	2	4,2 x 26	2

* 1 connector consists of 2 individual parts

a) D= assembly thickness

b) Included in delivery

Art. no.	Name	Dimensions W x H x D ^{a)} [mm]	Main beam		Secondary beam surface-mounted		Secondary beam flush-mounted				characteristic load-bearing capacity FR _k ^{d)}			
			min. W _{MB}	min. H _{MB}	min. W _{SB}	min. H _{SB}	min. W _{SB} ^{b)}	min. H _{SB}	W _M	D _M ^{c)}	F _{1,Rk}	F _{2,Rk}	F _{3,Rk}	F _{4,Rk}
			[mm]	[mm]	[mm]	[mm]	[mm]	[mm]	[mm]	[mm]	[kN]	[kN]	[kN]	[kN]
944875	Magnus S 50 x 60	50 x 60 x 13	60	80	60	80	80	80	50	13	3,73	7,25	5,00	1,92

a) D= assembly thickness

b) Included in delivery

c) Recommended minimum width of the secondary beam with the connector flush-mounted

d) To make installation easier, it is advantageous to reduce the milling depth slightly, especially for larger wood dimensions.

e) Both beams softwood with a gross density of ρ_k= 380 kg/m³.

The specified characteristic values of the load-bearing capacity FR_k apply to the specified timber cross-sections, centred force application along the respective beam axis as well as connector installation flush with the top edge of the main and secondary beams.

Calculation according to ETA 15/0761. All mechanical values provided should be subject to the assumptions that have been made and represent example calculations.

All values are calculated minimum values and are subject to typographical and printing errors.

The characteristic values of the load-bearing capacity FR_k should not be treated as equivalent to the max. possible load (the max. force). The characteristic values of the load-bearing capacity FR_k should be reduced to the design values FR_d in terms of the service class and the load duration class: FR_d= FR_k x k_{mod} / γ_M.

Please note: These are planning aids. Projects must only be calculated by authorised persons.

MAGNUS S 50 X 80

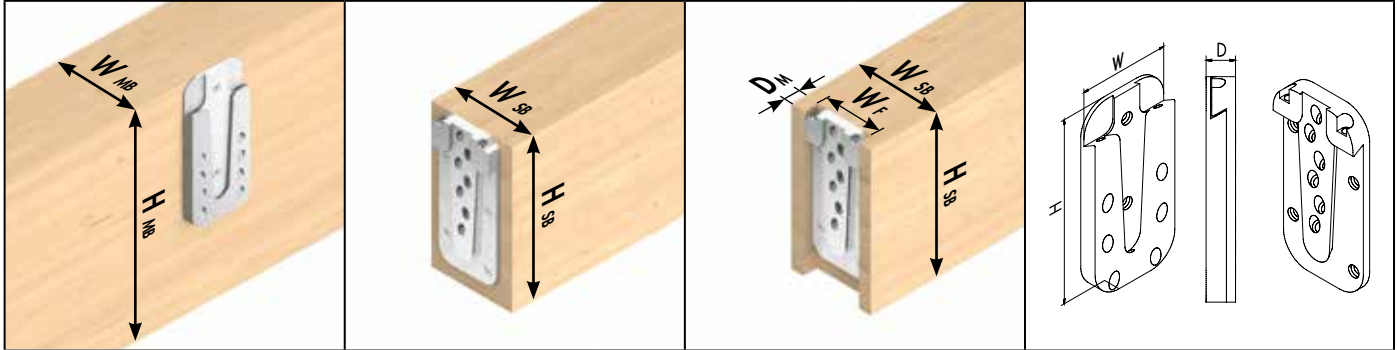

Symbolic illustrations: f.l.t.r. Main beam, secondary beam surface-mounted, secondary beam flush-mounted, connector dimensions

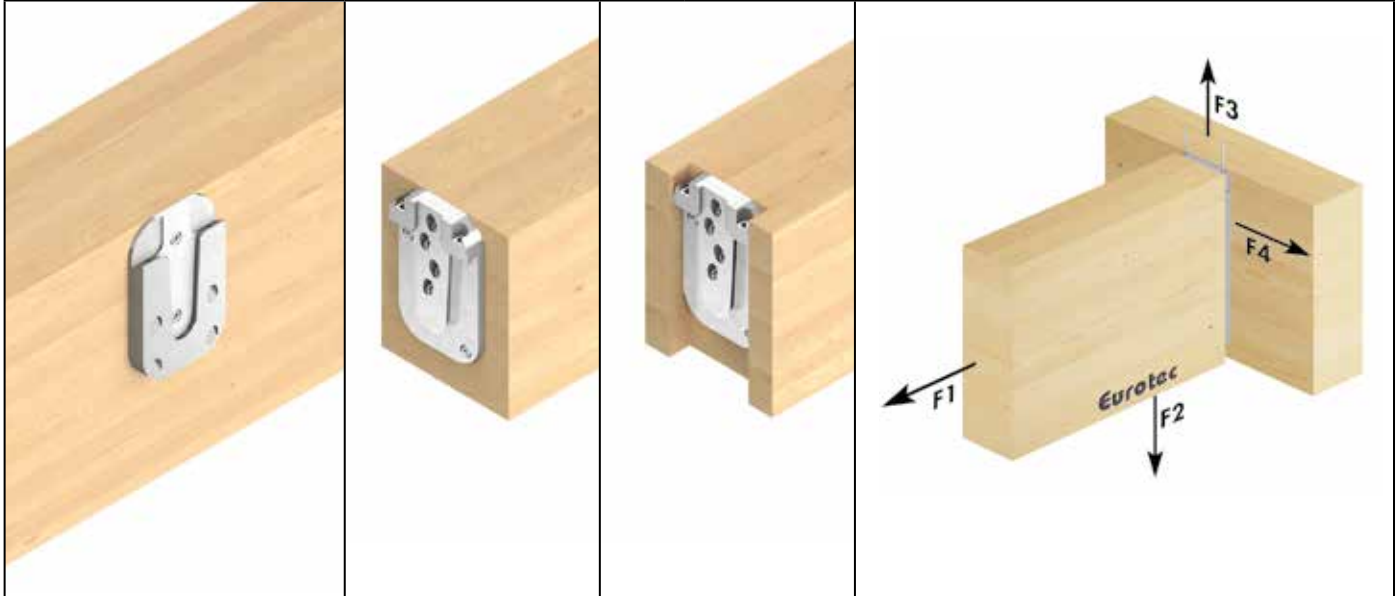

Art. no.	Name	Dimensions W x H x D ^{a)} [mm]	PU*	Fully threaded screws ^{b)}						Fixing screws ^{b)}	
				Dimensions [mm]	n _{total}	In the main beam		In the secondary beam		Dimensions [mm]	n
						n90°	n45°	n90°	n45°		
944876	Magnus S 50 x 80	50 x 80 x 13	10	4,0 x 60	12	2	4	2	4	4,2 x 26	2

* 1 connector consists of 2 individual parts

a) D= assembly thickness

b) Included in delivery

Art. no.	Name	Dimensions W x H x D ^{a)} [mm]	Main beam		Secondary beam surface-mounted		Secondary beam flush-mounted			characteristic load-bearing capacity FR _k ^{d)}				
			min. W _{MB}	min. H _{MB}	min. W _{SB}	min. H _{SB}	min. W _{SB} ^{b)}	min. H _{SB}	W _M	D _M ^{c)}	F _{1,Rk}	F _{2,Rk}	F _{3,Rk}	F _{4,Rk}
			[mm]	[mm]	[mm]	[mm]	[mm]	[mm]	[mm]	[mm]	[kN]	[kN]	[kN]	[kN]
944876	Magnus S 50 x 80	50 x 80 x 13	60	100	60	100	80	100	50	13	3,73	14,50	5,00	2,80

a) D= assembly thickness

b) Included in delivery

c) Recommended minimum width of the secondary beam with the connector flush-mounted

d) To make installation easier, it is advantageous to reduce the milling depth slightly, especially for larger wood dimensions.

e) Both beams softwood with a gross density of ρ_k= 380 kg/m³.

The specified characteristic values of the load-bearing capacity FR_k apply to the specified timber cross-sections, centred force application along the respective beam axis as well as connector installation flush with the top edge of the main and secondary beams.

Calculation according to ETA 15/0761. All mechanical values provided should be viewed as subject to the assumptions that have been made and represent example calculations.

All values are calculated minimum values and are subject to typographical and printing errors.

The characteristic values of the load-bearing capacity FR_k should not be treated as equivalent to the max. possible load (the max. force). The characteristic values of the load-bearing capacity FR_k should be reduced to the design values FR_d in terms of the service class and the load duration class: FR_d= FR_k x k_{mod} / γ_M.

Please note: These are planning aids. Projects must only be calculated by authorised persons.

MAGNUS S 50 X 100

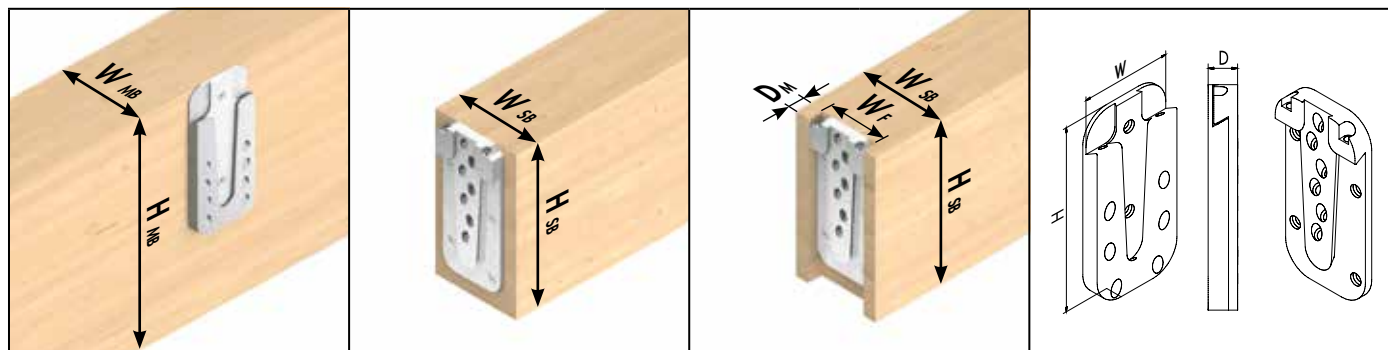

Symbolic illustrations: f.l.t.r. Main beam, secondary beam surface-mounted, secondary beam flush-mounted, connector dimensions

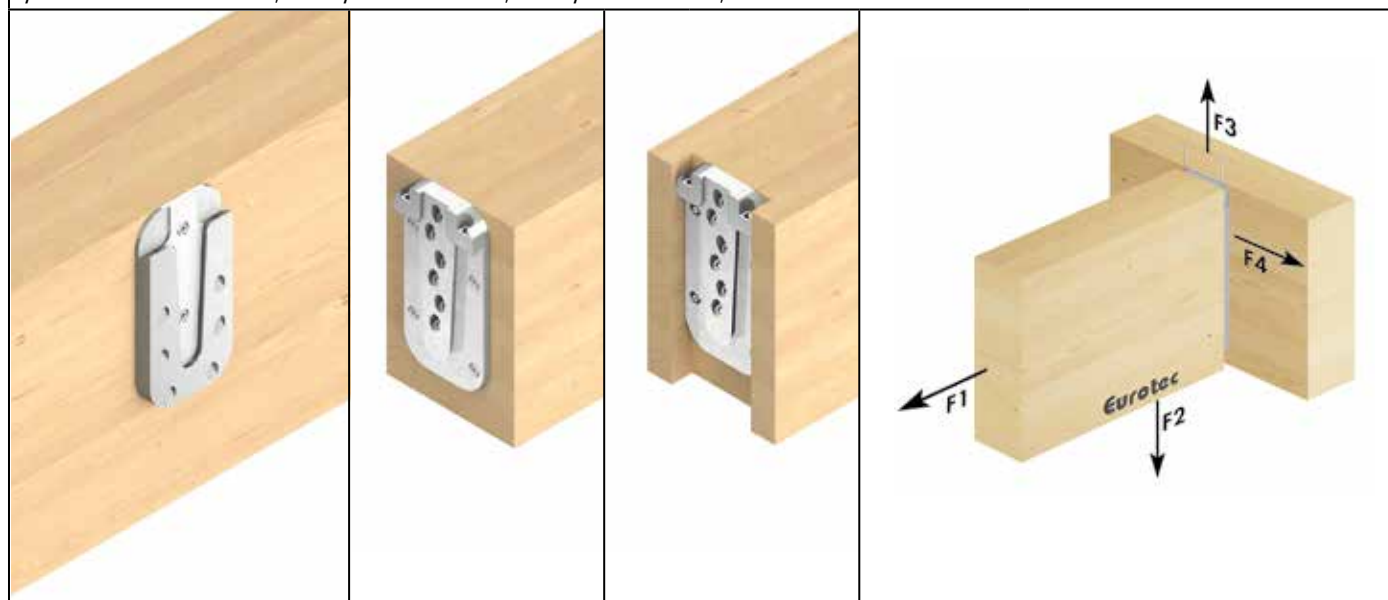

Art. no.	Name	Dimensions		PU*	Fully threaded screws ^{b)}					Fixing screws ^{b)}		
		W x H x D ^{a)}			Dimensions	n _{total}	In the main beam		In the secondary beam		Dimensions	n
		[mm]					[mm]	n _{90°}	n _{45°}	n _{90°}		
944877	Magnus S 50 x 100	50	100 x 13	10	4,0 x 60	18	2	6	4	6	4,2 x 26	2

* 1 connector consists of 2 individual parts

a) D= assembly thickness

b) Included in delivery

Art. no.	Name	Dimensions	Main beam		Secondary beam surface-mounted		Secondary beam flush-mounted		characteristic load-bearing capacity FR _k ^{d)}					
		W x H x D ^{a)}	min. W _{MB}	min. H _{MB}	min. W _{SB}	min. H _{SB}	min. W _{SB} ^{b)}	min. H _{SB}	W _M	D _M ^{c)}	F _{1,Rk}	F _{2,Rk}	F _{3,Rk}	F _{4,Rk}
		[mm]	[mm]	[mm]	[mm]	[mm]	[mm]	[mm]	[mm]	[mm]	[kN]	[kN]	[kN]	[kN]
944877	Magnus S 50 x 100	50 x 100 x 13	60	120	60	120	80	120	50	13	7,46	21,75	5,00	4,41

a) D= assembly thickness

b) Included in delivery

c) Recommended minimum width of the secondary beam with the connector flush-mounted

d) To make installation easier, it is advantageous to reduce the milling depth slightly, especially for larger wood dimensions.

e) Both beams softwood with a gross density of $\rho_k = 380 \text{ kg/m}^3$.The specified characteristic values of the load-bearing capacity FR_k apply to the specified timber cross-sections, centred force application along the respective beam axis as well as connector installation flush with the top edge of the main and secondary beams. Calculation according to ETA 15/0761. All mechanical values provided should be viewed as subject to the assumptions that have been made and represent example calculations.

All values are calculated minimum values and are subject to typographical and printing errors.

The characteristic values of the load-bearing capacity FR_k should not be treated as equivalent to the max. possible load (the max. force). The characteristic values of the load-bearing capacity FR_k should be reduced to the design values FR_d in terms of the service class and the load duration class: $FR_d = FR_k \times k_{mod} / \gamma_M$.

Please note: These are planning aids. Projects must only be calculated by authorised persons.

MAGNUS M 70 X 120

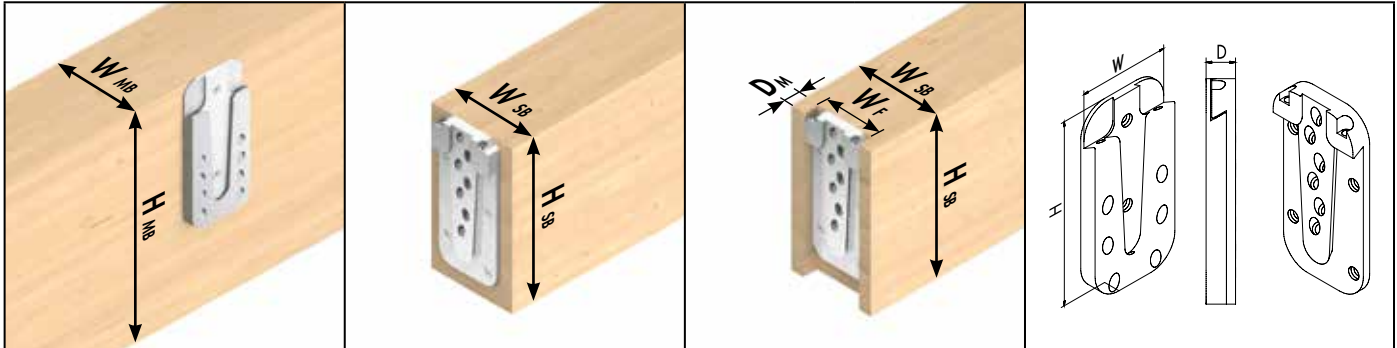

Symbolic illustrations: f.l.t.r. Main beam, secondary beam surface-mounted, secondary beam flush-mounted, connector dimensions

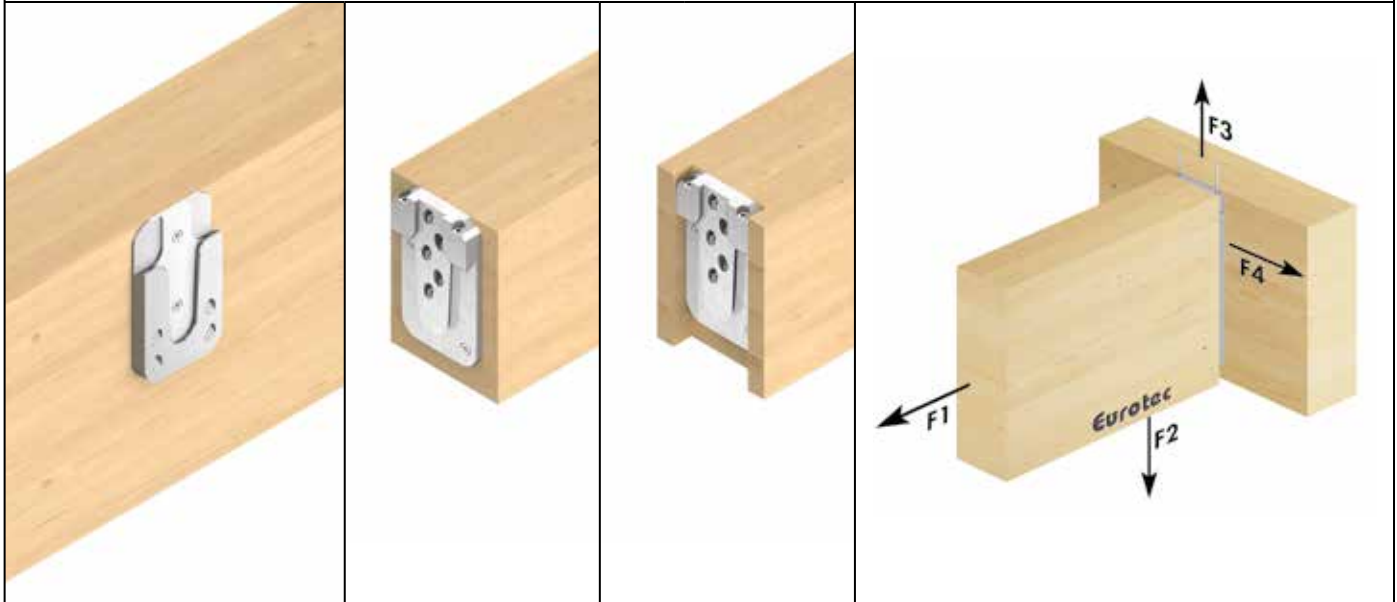

Art. no.	Name	Dimensions		PU*	Fully threaded screws ^{b)}					Fixing screws ^{b)}		
		W x H x D ^{a)}			Dimensions	n _{total}	In the main beam		In the secondary beam		Dimensions	n
		[mm]					[mm]	n _{total}	90°	45°		
944878	Magnus M 70 x 120	70 x 120 x 17		10	5,0 x 80	13	2	4	2	5	4,8 x 60	2

* 1 connector consists of 2 individual parts

a) D= assembly thickness

b) Included in delivery

Art. no.	Name	Dimensions		Main beam		Secondary beam surface-mounted		Secondary beam flush-mounted		characteristic load-bearing capacity FR _k ^{d)}					
		W x H x D ^{a)}		min. W _{MB}	min. H _{MB}	min. W _{SB}	min. H _{SB}	min. W _{SB} ^{b)}	min. H _{SB}	W _M	D _M ^{c)}	F _{1,Rk}	F _{2,Rk}	F _{3,Rk}	F _{4,Rk}
		[mm]		[mm]	[mm]	[mm]	[mm]	[mm]	[mm]	[mm]	[mm]	[kN]	[kN]	[kN]	[kN]
944878	Magnus M 70 x 120	70 x 120 x 17		80	140	80	140	100	140	70	17	5,49	21,34	13,00	5,17

a) D= assembly thickness

b) Included in delivery

c) Recommended minimum width of the secondary beam with the connector flush-mounted

d) To make installation easier, it is advantageous to reduce the milling depth slightly, especially for larger wood dimensions.

e) Both beams softwood with a gross density of ρ_k= 380 kg/m³.

The specified characteristic values of the load-bearing capacity FR_k apply to the specified timber cross-sections, centred force application along the respective beam axis as well as connector installation flush with the top edge of the main and secondary beams.

Calculation according to ETA 15/0761. All mechanical values provided should be viewed as subject to the assumptions that have been made and represent example calculations.

All values are calculated minimum values and are subject to typographical and printing errors.

The characteristic values of the load-bearing capacity FR_k should not be treated as equivalent to the max. possible load (the max. force). The characteristic values of the load-bearing capacity FR_k should be reduced to the design values FR_d in terms of the service class and the load duration class: FR_d= FR_k x k_{mod} / γ_M.

Please note: These are planning aids. Projects must only be calculated by authorised persons.

MAGNUS M 70 X 140

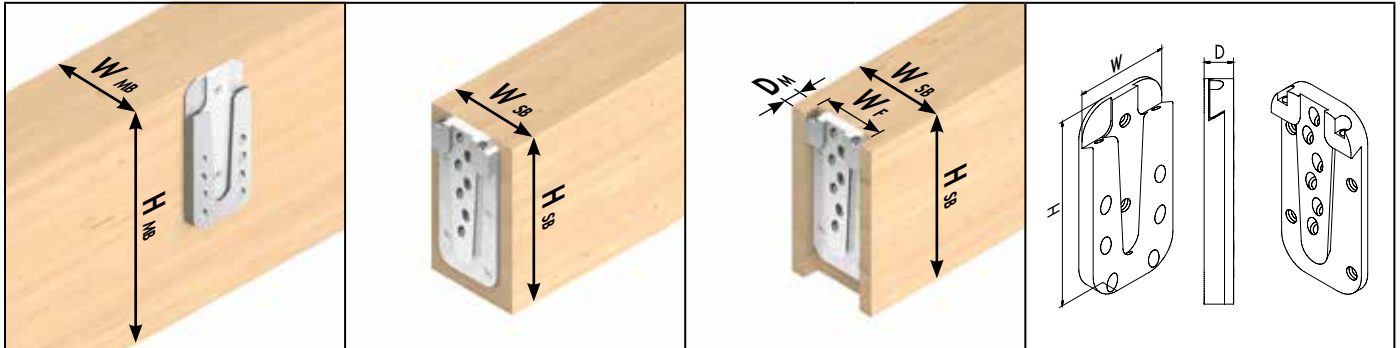

Symbolic illustrations: f.l.t.r. Main beam, secondary beam surface-mounted, secondary beam flush-mounted, connector dimensions

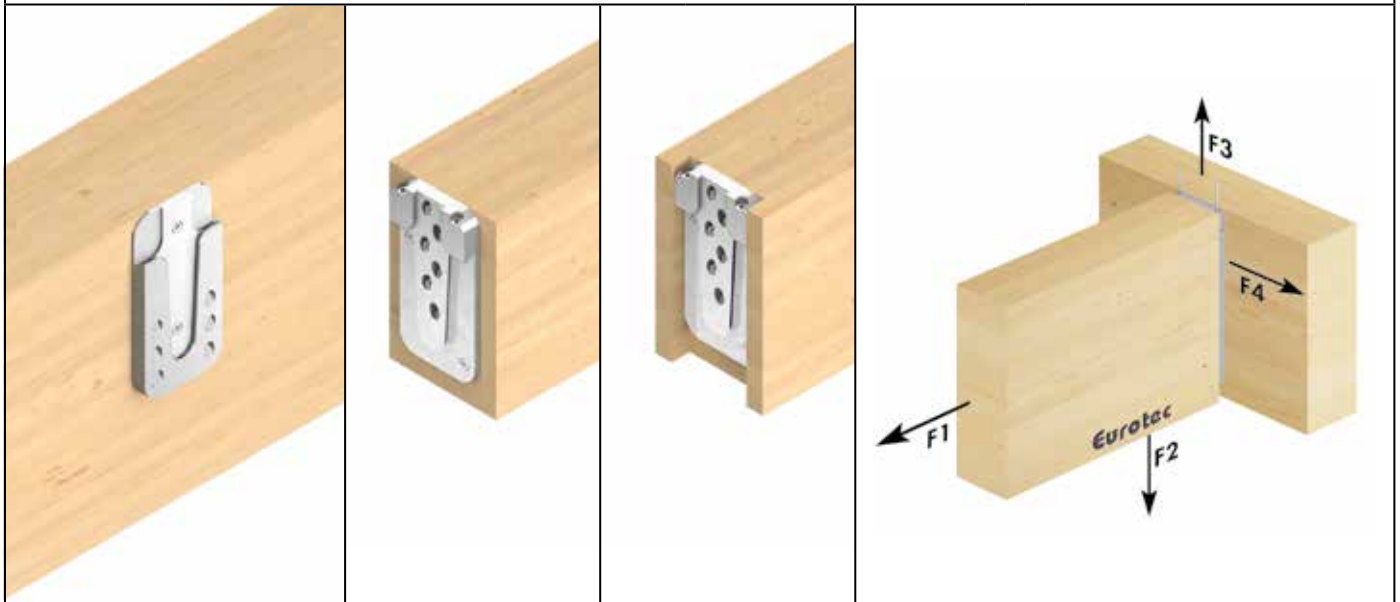

Art. no.	Name	Dimensions		PU*	Fully threaded screws ^{b)}					Fixing screws ^{b)}				
		W x H x D ^{a)}			Dimensions	n _{total}	In the main beam		In the secondary beam		Dimensions	n		
		[mm]					[mm]	n _{90°}	n _{45°}	n _{90°}			n _{45°}	[mm]
944879	Magnus M 70 x 140	70	140	17	5,0	80	16	2	6	2	6	4,8	60	2

* 1 connector consists of 2 individual parts

a) D= assembly thickness

b) Included in delivery

Art. no.	Name	Dimensions		Main beam		Secondary beam surface-mounted		Secondary beam flush-mounted		characteristic load-bearing capacity FR _k ^{d)}						
		W x H x D ^{a)}		min. W _{MB}	min. H _{MB}	min. W _{SB}	min. H _{SB}	min. W _{SB} ^{b)}	min. H _{SB}	W _M	D _M ^{c)}	F _{1,Rk}	F _{2,Rk}	F _{3,Rk}	F _{4,Rk}	
		[mm]		[mm]	[mm]	[mm]	[mm]	[mm]	[mm]	[mm]	[mm]	[kN]	[kN]	[kN]	[kN]	
944879	Magnus M 70 x 140	70	140	17	80	160	80	160	100	160	70	17	5,49	32,00	13,00	6,09

a) D= assembly thickness

b) Included in delivery

c) Recommended minimum width of the secondary beam with the connector flush-mounted

d) To make installation easier, it is advantageous to reduce the milling depth slightly, especially for larger wood dimensions.

e) Both beams softwood with a gross density of $\rho_k = 380 \text{ kg/m}^3$.The specified characteristic values of the load-bearing capacity FR_k apply to the specified timber cross-sections, centred force application along the respective beam axis as well as connector installation flush with the top edge of the main and secondary beams. Calculation according to ETA 15/0761. All mechanical values provided should be viewed as subject to the assumptions that have been made and represent example calculations.

All values are calculated minimum values and are subject to typographical and printing errors.

The characteristic values of the load-bearing capacity FR_k should not be treated as equivalent to the max. possible load (the max. force). The characteristic values of the load-bearing capacity FR_k should be reduced to the design values FR_d in terms of the service class and the load duration class: $FR_d = FR_k \times k_{mod} / \gamma_M$.

Please note: These are planning aids. Projects must only be calculated by authorised persons.

MAGNUS M 70 X 160

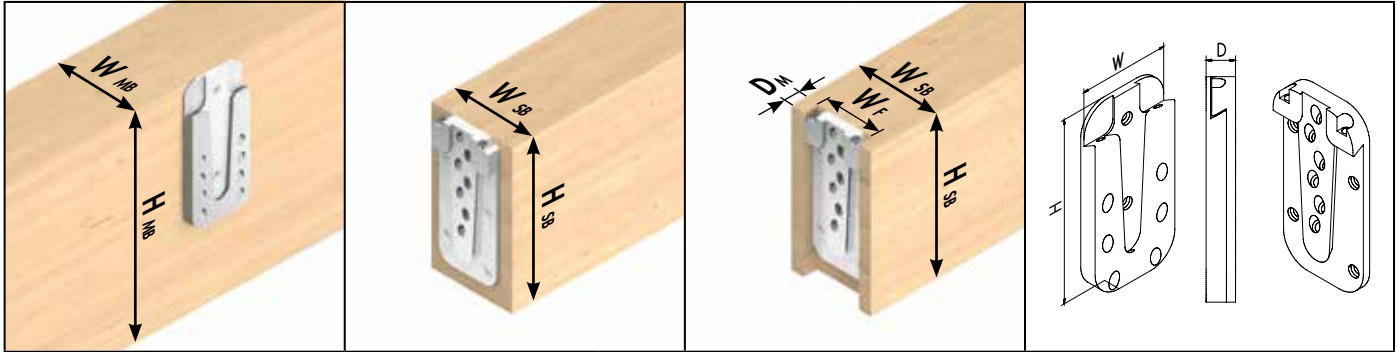

Symbolic illustrations: f.l.t.r. Main beam, secondary beam surface-mounted, secondary beam flush-mounted, connector dimensions

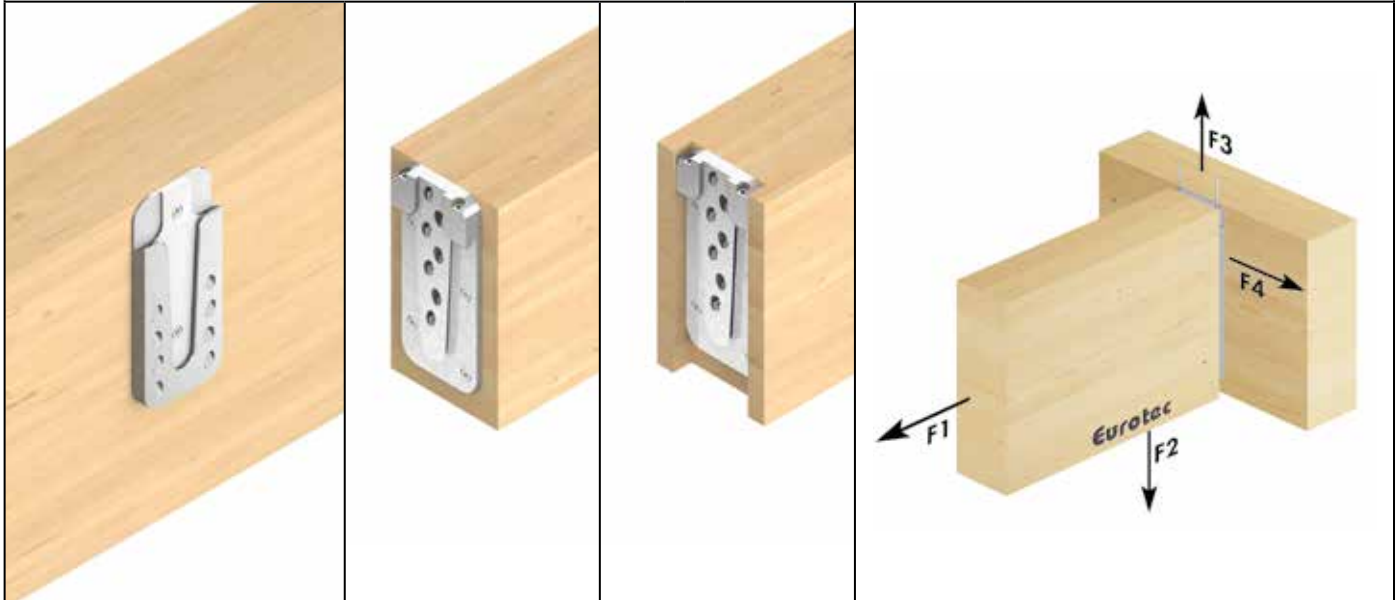

Art. no.	Name	Dimensions		PU*	Fully threaded screws ^{b)}						Fixing screws ^{b)}	
		W x H x D ^{a)}			Dimensions	n _{total}	In the main beam		In the secondary beam		Dimensions	n
		[mm]					[mm]		90°	45°		
944880	Magnus M 70 x 160	70 x 160 x 17		10	5,0 x 80	21	2	8	4	7	4,8 x 60	2

* 1 connector consists of 2 individual parts
a) D= assembly thickness
b) Included in delivery

Art. no.	Name	Dimensions	Main beam		Secondary beam surface-mounted		Secondary beam flush-mounted		characteristic load-bearing capacity FR _k ^{d)}					
		W x H x D ^{a)}	min. W _{MB}	min. H _{MB}	min. W _{SB}	min. H _{SB}	min. W _{SB} ^{b)}	min. H _{SB}	W _M	D _M ^{c)}	F _{1,Rk}	F _{2,Rk}	F _{3,Rk}	F _{4,Rk}
		[mm]	[mm]	[mm]	[mm]	[mm]	[mm]	[mm]	[mm]	[mm]	[kN]	[kN]	[kN]	[kN]
944880	Magnus M 70 x 160	70 x 160 x 17	80	180	80	180	100	180	70	17	10,98	37,34	13,00	8,27

a) D= assembly thickness
b) Included in delivery
c) Recommended minimum width of the secondary beam with the connector flush-mounted
d) To make installation easier, it is advantageous to reduce the milling depth slightly, especially for larger wood dimensions.
e) Both beams softwood with a gross density of ρ_k= 380 kg/m³.
The specified characteristic values of the load-bearing capacity FR_k apply to the specified timber cross-sections, centred force application along the respective beam axis as well as connector installation flush with the top edge of the main and secondary beams. Calculation according to ETA 15/0761. All mechanical values provided should be viewed as subject to the assumptions that have been made and represent example calculations. All values are calculated minimum values and are subject to typographical and printing errors. The characteristic values of the load-bearing capacity FR_k should not be treated as equivalent to the max. possible load (the max. force). The characteristic values of the load-bearing capacity FR_k should be reduced to the design values FR_d in terms of the service class and the load duration class: FR_d= FR_k x k_{mod} / γ_M.

Please note: These are planning aids. Projects must only be calculated by authorised persons.

MAGNUS M 70 X 180

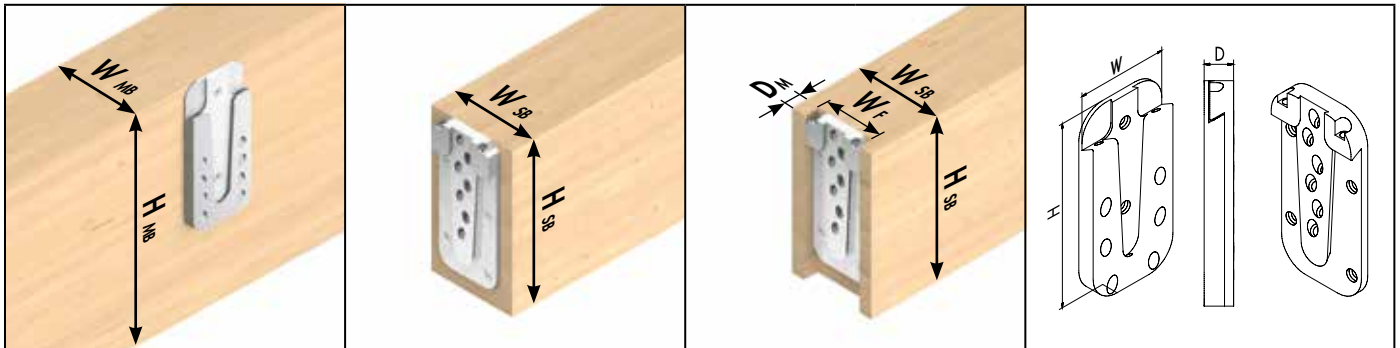

Symbolic illustrations: f.l.t.r. Main beam, secondary beam surface-mounted, secondary beam flush-mounted, connector dimensions

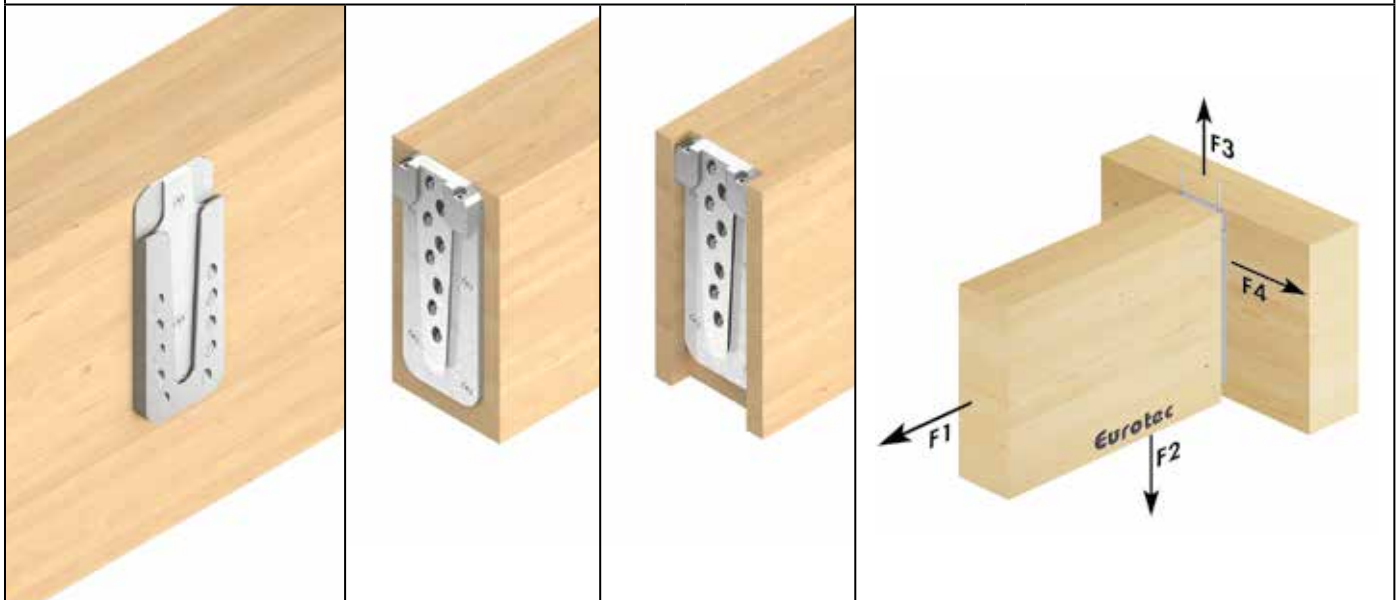

Art. no.	Name	Dimensions		PU*	Fully threaded screws ^{b)}					Fixing screws ^{b)}			
		W x H x D ^{a)}			Dimensions		n _{total}	In the main beam		In the secondary beam		Dimensions	n
		[mm]			[mm]			n _{90°}	n _{45°}	n _{90°}	n _{45°}	[mm]	
944881	Magnus M 70 x 180	70	180 x 17	10	5,0 x 80	24	2	10	4	8	4,8 x 60	2	

* 1 connector consists of 2 individual parts

a) D= assembly thickness

b) Included in delivery

Art. no.	Name	Dimensions		Main beam		Secondary beam surface-mounted		Secondary beam flush-mounted		characteristic load-bearing capacity FR _k ^{d)}					
		W x H x D ^{a)}		min. W _{MB}	min. H _{MB}	min. W _{SB}	min. H _{SB}	min. W _{SB} ^{b)}	min. H _{SB}	W _M	D _M ^{c)}	F _{1,Rk}	F _{2,Rk}	F _{3,Rk}	F _{4,Rk}
		[mm]		[mm]	[mm]	[mm]	[mm]	[mm]	[mm]	[mm]	[mm]	[kN]	[kN]	[kN]	[kN]
944881	Magnus M 70 x 180	70	180 x 17	80	200	80	200	100	200	70	17	10,98	42,67	13,00	9,32

a) D= assembly thickness

b) Included in delivery

c) Recommended minimum width of the secondary beam with the connector flush-mounted

d) To make installation easier, it is advantageous to reduce the milling depth slightly, especially for larger wood dimensions.

e) Both beams softwood with a gross density of $\rho_k = 380 \text{ kg/m}^3$.The specified characteristic values of the load-bearing capacity FR_k apply to the specified timber cross-sections, centred force application along the respective beam axis as well as connector installation flush with the top edge of the main and secondary beams. Calculation according to ETA 15/0761. All mechanical values provided should be viewed as subject to the assumptions that have been made and represent example calculations.

All values are calculated minimum values and are subject to typographical and printing errors.

The characteristic values of the load-bearing capacity FR_k should not be treated as equivalent to the max. possible load (the max. force). The characteristic values of the load-bearing capacity FR_k should be reduced to the design values FR_d in terms of the service class and the load duration class: $FR_d = FR_k \times k_{mod} / \gamma_M$.

Please note: These are planning aids. Projects must only be calculated by authorised persons.

MAGNUS L 110 X 220

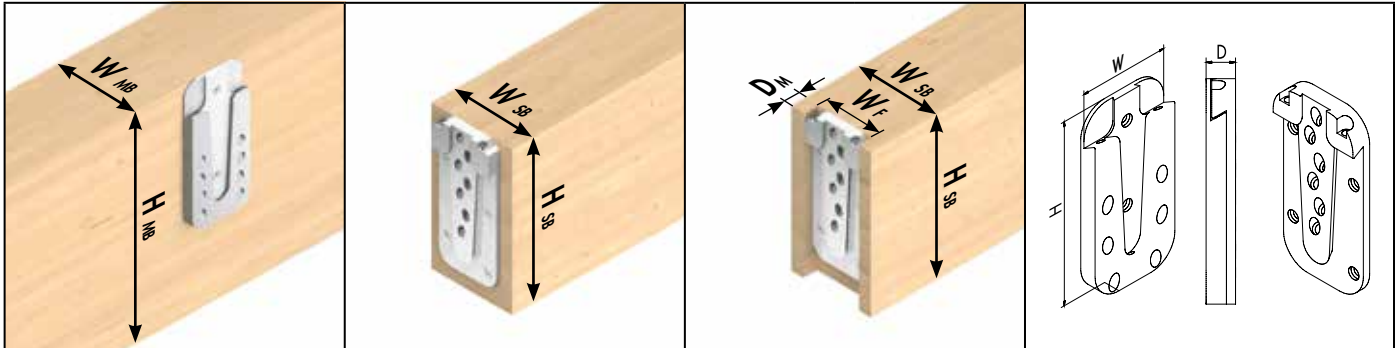

Symbolic illustrations: f.l.t.r. Main beam, secondary beam surface-mounted, secondary beam flush-mounted, connector dimensions

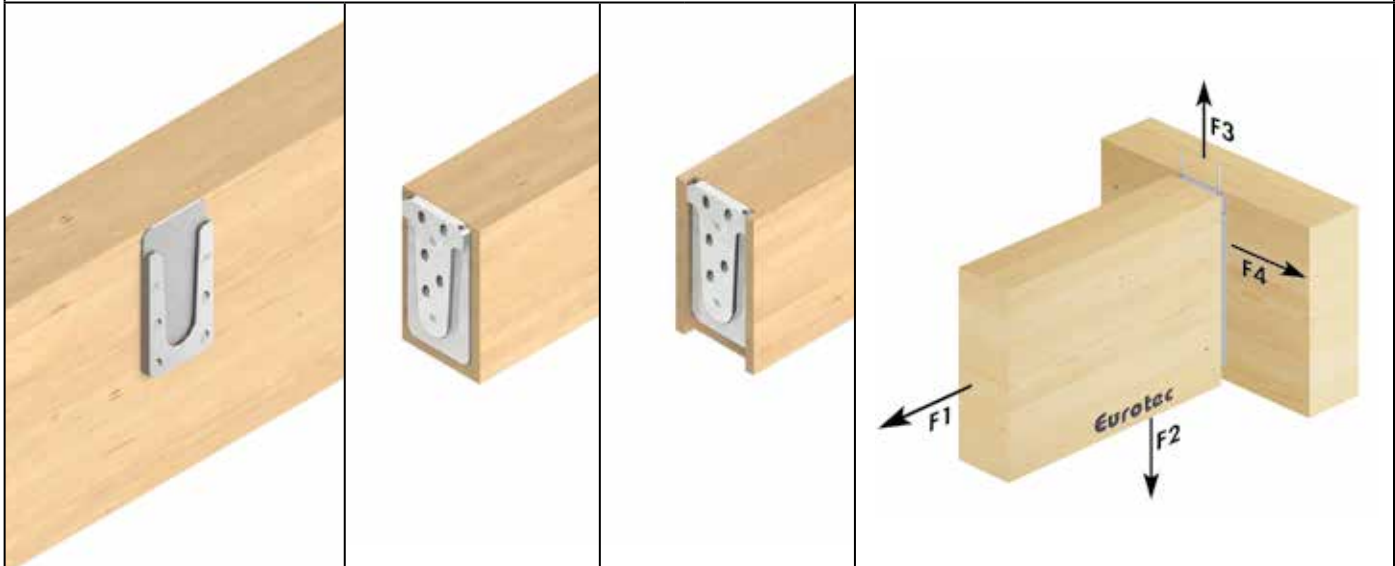

Art. no.	Name	Dimensions		PU*	Fully threaded screws ^{b)}					Fixing screws ^{b)}		
		W x H x D ^{a)}			Dimensions	n _{total}	In the main beam		In the secondary beam		Dimensions	n
		[mm]					[mm]	n _{90°}	n _{45°}	n _{90°}		
944882	Magnus L 110 x 220	110 x 220 x 19		4	8,0 x 120	13	2	4	2	5	4,8 x 60	2

* 1 connector consists of 2 individual parts

a) D= assembly thickness

b) Included in delivery

Art. no.	Name	Dimensions		Main beam		Secondary beam surface-mounted		Secondary beam flush-mounted		characteristic load-bearing capacity FR _k ^{d)}					
		W x H x D ^{a)}		min. W _{MB}	min. H _{MB}	min. W _{SB}	min. H _{SB}	min. W _{SB} ^{b)}	min. H _{SB}	W _M	D _M ^{c)}	F _{1,Rk}	F _{2,Rk}	F _{3,Rk}	F _{4,Rk}
		[mm]		[mm]	[mm]	[mm]	[mm]	[mm]	[mm]	[mm]	[mm]	[kN]	[kN]	[kN]	[kN]
944882	Magnus L 110 x 220	110 x 220 x 19		120	240	120	240	140	240	110	19	9,29	36,10	23,00	13,96

a) D= assembly thickness

b) Included in delivery

c) Recommended minimum width of the secondary beam with the connector flush-mounted

d) To make installation easier, it is advantageous to reduce the milling depth slightly, especially for larger wood dimensions.

e) Both beams softwood with a gross density of ρ_k= 380 kg/m³.

The specified characteristic values of the load-bearing capacity FR_k apply to the specified timber cross-sections, centred force application along the respective beam axis as well as connector installation flush with the top edge of the main and secondary beams. Calculation according to ETA 15/0761. All mechanical values provided should be viewed as subject to the assumptions that have been made and represent example calculations.

All values are calculated minimum values and are subject to typographical and printing errors.

The characteristic values of the load-bearing capacity FR_k should not be treated as equivalent to the max. possible load (the max. force). The characteristic values of the load-bearing capacity FR_k should be reduced to the design values FR_d in terms of the service class and the load duration class: FR_d= FR_k x k_{mod} / γ_M.

The characteristic load-bearing capacities for the L series were determined using 8 x 120 VG screws. Higher capacities can be achieved with longer screws (however, the minimum cross-sections of the supports also change)

Please note: These are planning aids. Projects must only be calculated by authorised persons.

MAGNUS L 110 X 260

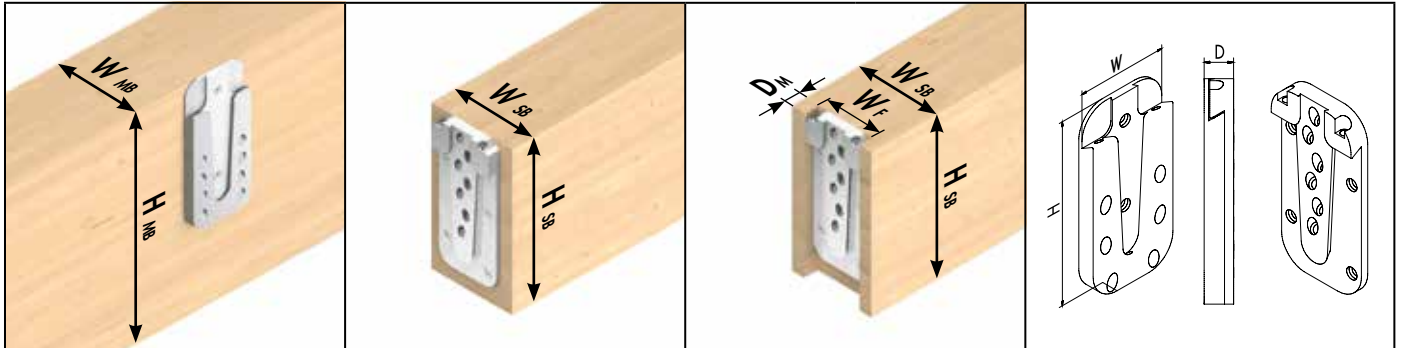

Symbolic illustrations: f.l.t.r. Main beam, secondary beam surface-mounted, secondary beam flush-mounted, connector dimensions

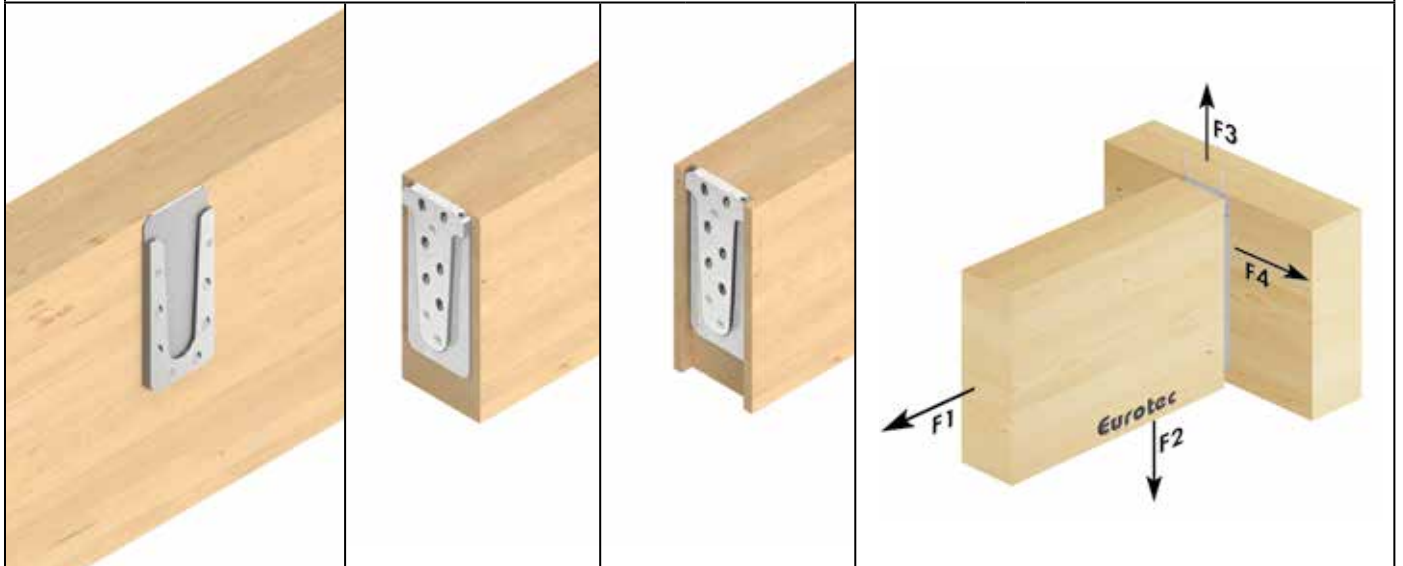

Art. no.	Name	Dimensions	PU*	Fully threaded screws ^{b)}						Fixing screws ^{b)}	
		W x H x D ^{a)}		Dimensions [mm]	n _{total}	In the main beam		In the secondary beam		Dimensions [mm]	n
		[mm]				n _{90°}	n _{45°}	n _{90°}	n _{45°}		
944883	Magnus L 110 x 260	110 x 260 x 19	4	8,0 x 120	17	3	5	3	6	4,8 x 60	2

* 1 connector consists of 2 individual parts

a) D= assembly thickness

b) Included in delivery

Art. no.	Name	Dimensions	Main beam		Secondary beam surface-mounted		Secondary beam flush-mounted		characteristic load-bearing capacity FR _k ^{d)}					
		W x H x D ^{a)}	min. W _{MB}	min. H _{MB}	min. W _{SB}	min. H _{SB}	min. W _{SB} ^{b)}	min. H _{SB}	W _M	D _M ^{c)}	F _{1,Rk}	F _{2,Rk}	F _{3,Rk}	F _{4,Rk}
		[mm]	[mm]	[mm]	[mm]	[mm]	[mm]	[mm]	[mm]	[mm]	[kN]	[kN]	[kN]	[kN]
944883	Magnus L 110 x 260	110 x 260 x 19	120	280	120	280	140	280	110	19	13,93	45,13	23,00	17,98

a) D= assembly thickness

b) Included in delivery

c) Recommended minimum width of the secondary beam with the connector flush-mounted

d) To make installation easier, it is advantageous to reduce the milling depth slightly, especially for larger wood dimensions.

e) Both beams softwood with a gross density of $\rho_k = 380 \text{ kg/m}^3$.

The specified characteristic values of the load-bearing capacity FR_k apply to the specified timber cross-sections, centred force application along the respective beam axis as well as connector installation flush with the top edge of the main and secondary beams. Calculation according to ETA 15/0761. All mechanical values provided should be viewed as subject to the assumptions that have been made and represent example calculations.

All values are calculated minimum values and are subject to typographical and printing errors.

The characteristic values of the load-bearing capacity FR_k should not be treated as equivalent to the max. possible load (the max. force). The characteristic values of the load-bearing capacity FR_k should be reduced to the design values FR_d in terms of the service class and the load duration class: $FR_d = FR_k \times k_{mod} / \gamma_M$.

The characteristic load-bearing capacities for the L series were determined using 8 x 120 VG screws. Higher capacities can be achieved with longer screws (however, the minimum cross-sections of the supports also change)

Please note: These are planning aids. Projects must only be calculated by authorised persons.

MAGNUS L 110 X 300

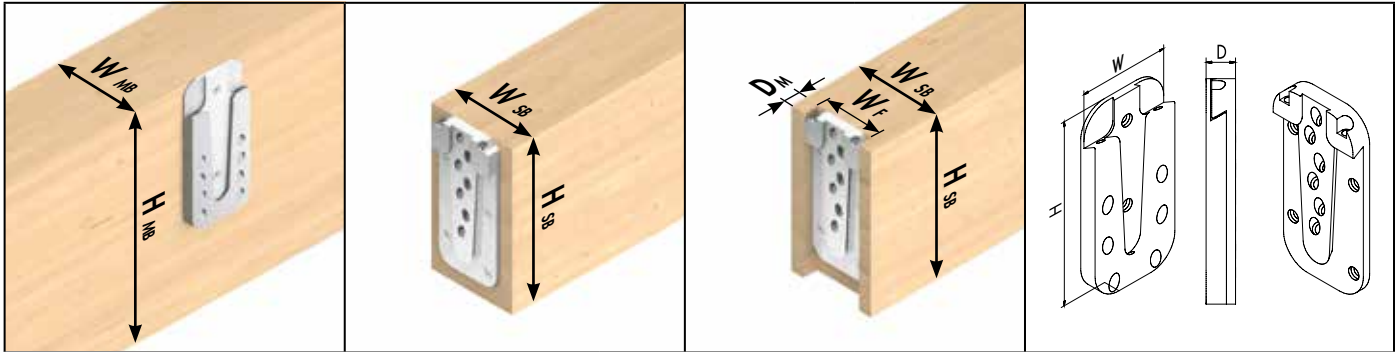

Symbolic illustrations: f.l.t.r. Main beam, secondary beam surface-mounted, secondary beam flush-mounted, connector dimensions

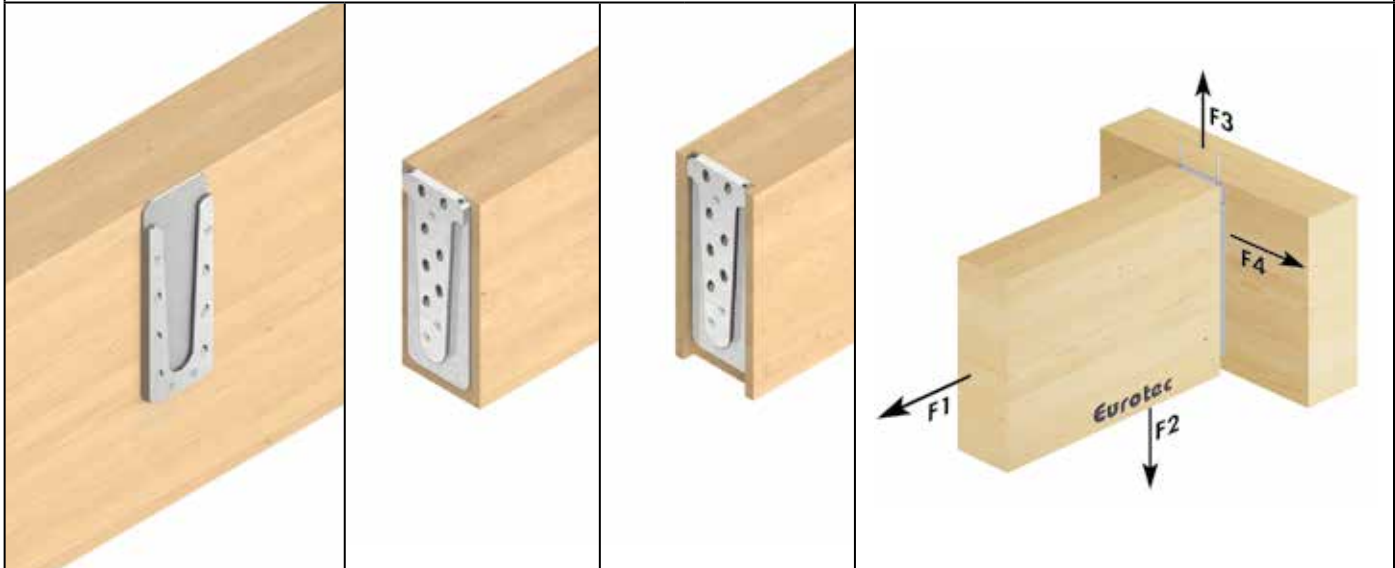

Art. no.	Name	Dimensions		PU*	Fully threaded screws ^{b)}					Fixing screws ^{b)}		
		W x H x D ^{a)}			Dimensions	n _{total}	In the main beam		In the secondary beam		Dimensions	n
		[mm]					[mm]	n _{90°}	n _{45°}	n _{90°}		
944884	Magnus L 110 x 300	110 x 300 x 19		4	8,0 x 120	20	4	6	3	7	4,8 x 60	2

* 1 connector consists of 2 individual parts

a) D= assembly thickness

b) Included in delivery

Art. no.	Name	Dimensions		Main beam		Secondary beam surface-mounted		Secondary beam flush-mounted		characteristic load-bearing capacity FR _k ^{d)}					
		W x H x D ^{a)}		min. W _{MB}	min. H _{MB}	min. W _{SB}	min. H _{SB}	min. W _{SB} ^{b)}	min. H _{SB}	W _M	D _M ^{c)}	F _{1,Rk}	F _{2,Rk}	F _{3,Rk}	F _{4,Rk}
		[mm]		[mm]	[mm]	[mm]	[mm]	[mm]	[mm]	[mm]	[mm]	[kN]	[kN]	[kN]	[kN]
944884	Magnus L 110 x 300	110 x 300 x 19		120	320	120	320	140	320	110	19	13,93	54,15	23,00	20,56

a) D= assembly thickness

b) Included in delivery

c) Recommended minimum width of the secondary beam with the connector flush-mounted

d) To make installation easier, it is advantageous to reduce the milling depth slightly, especially for larger wood dimensions.

e) Both beams softwood with a gross density of ρ_k= 380 kg/m³.

The specified characteristic values of the load-bearing capacity FR_k apply to the specified timber cross-sections, centred force application along the respective beam axis as well as connector installation flush with the top edge of the main and secondary beams. Calculation according to ETA 15/0761. All mechanical values provided should be viewed as subject to the assumptions that have been made and represent example calculations.

All values are calculated minimum values and are subject to typographical and printing errors.

The characteristic values of the load-bearing capacity FR_k should not be treated as equivalent to the max. possible load (the max. force). The characteristic values of the load-bearing capacity FR_k should be reduced to the design values FR_d in terms of the service class and the load duration class: FR_d= FR_k x k_{mod} / γ_M.

The characteristic load-bearing capacities for the L series were determined using 8 x 120 VG screws. Higher capacities can be achieved with longer screws (however, the minimum cross-sections of the supports also change)

Please note: These are planning aids. Projects must only be calculated by authorised persons.

MAGNUS L 110 X 340

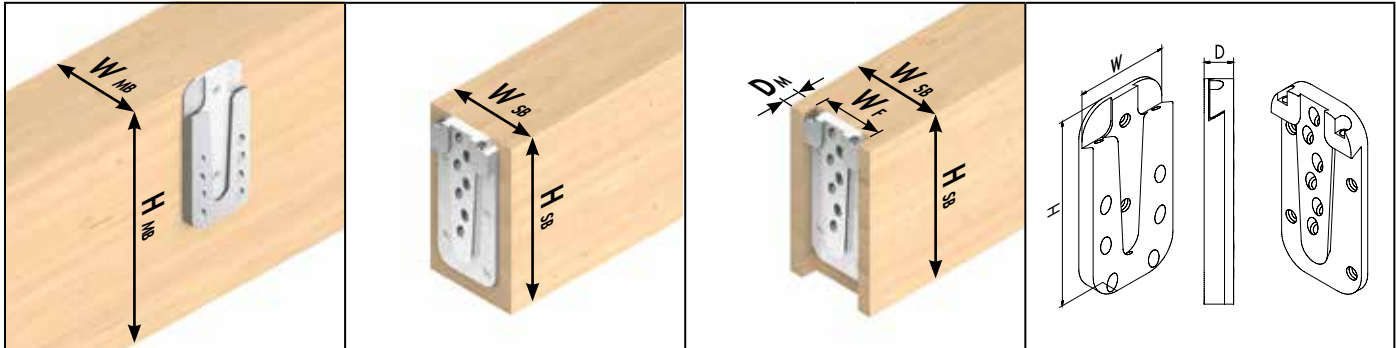

Symbolic illustrations: f.l.t.r. Main beam, secondary beam surface-mounted, secondary beam flush-mounted, connector dimensions

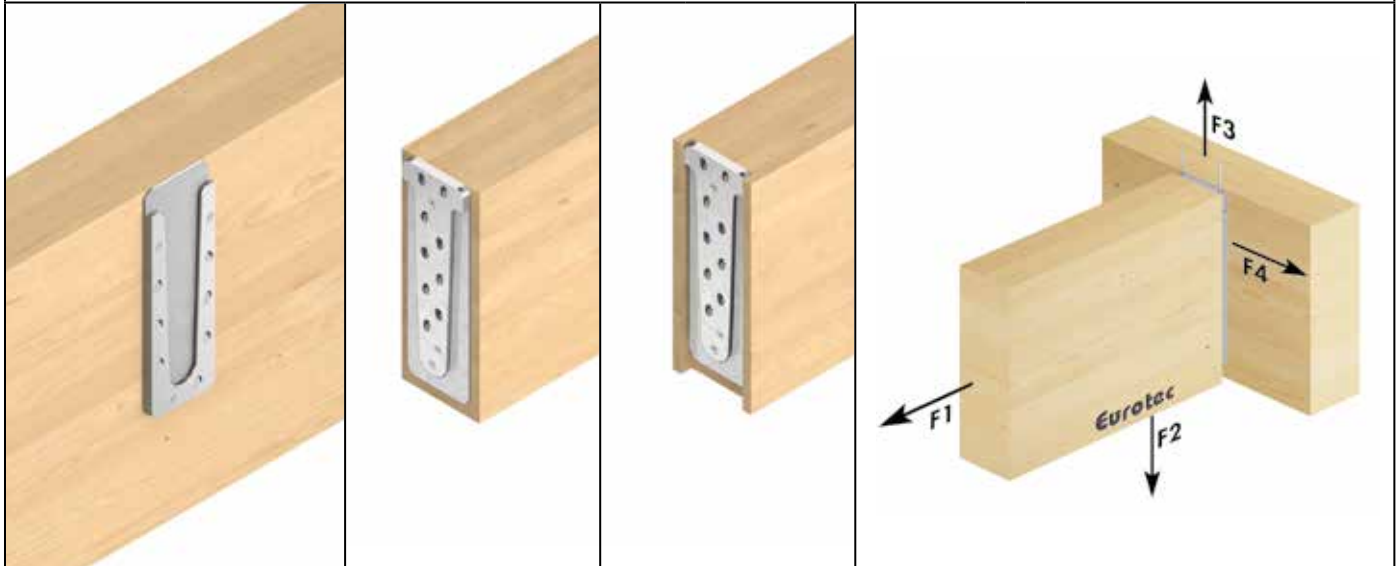

Art. no.	Name	Dimensions W x H x D ^{a)} [mm]	PU*	Fully threaded screws ^{b)}						Fixing screws ^{b)}	
				Dimensions [mm]	n ^{total}	In the main beam		In the secondary beam		Dimensions [mm]	n
						n90°	n45°	n90°	n45°		
944887	Magnus L 110 x 340	110 x 340 x 19	4	8,0 x 120	22	3	7	3	9	4,8 x 60	2

* 1 connector consists of 2 individual parts

a) D= assembly thickness

b) Included in delivery

Art. no.	Name	Dimensions W x H x D ^{a)} [mm]	Main beam		Secondary beam surface-mounted		Secondary beam flush-mounted		characteristic load-bearing capacity FR _k ^{d)}					
			min. W _{MB}	min. H _{MB}	min. W _{SB}	min. H _{SB}	min. W _{SB} ^{b)}	min. H _{SB}	W _M	D _M ^{c)}	F _{1,Rk}	F _{2,Rk}	F _{3,Rk}	F _{4,Rk}
			[mm]	[mm]	[mm]	[mm]	[mm]	[mm]	[mm]	[mm]	[kN]	[kN]	[kN]	[kN]
944887	Magnus L 110 x 340	110 x 340 x 19	120	360	120	360	140	360	110	19	13,93	63,18	23,00	24,67

a) D= assembly thickness

b) Included in delivery

c) Recommended minimum width of the secondary beam with the connector flush-mounted

d) To make installation easier, it is advantageous to reduce the milling depth slightly, especially for larger wood dimensions.

e) Both beams softwood with a gross density of ρ_k= 380 kg/m³.

The specified characteristic values of the load-bearing capacity FR_k apply to the specified timber cross-sections, centred force application along the respective beam axis as well as connector installation flush with the top edge of the main and secondary beams. Calculation according to ETA 15/0761. All mechanical values provided should be viewed as subject to the assumptions that have been made and represent example calculations.

All values are calculated minimum values and are subject to typographical and printing errors.

The characteristic values of the load-bearing capacity FR_k should not be treated as equivalent to the max. possible load (the max. force). The characteristic values of the load-bearing capacity FR_k should be reduced to the design values FR_d in terms of the service class and the load duration class: FR_d= FR_k x k_{mod} / γ_M.

The characteristic load-bearing capacities for the L series were determined using 8 x 120 VG screws. Higher capacities can be achieved with longer screws (however, the minimum cross-sections of the supports also change)

Please note: These are planning aids. Projects must only be calculated by authorised persons.

MAGNUS L 110 X 380

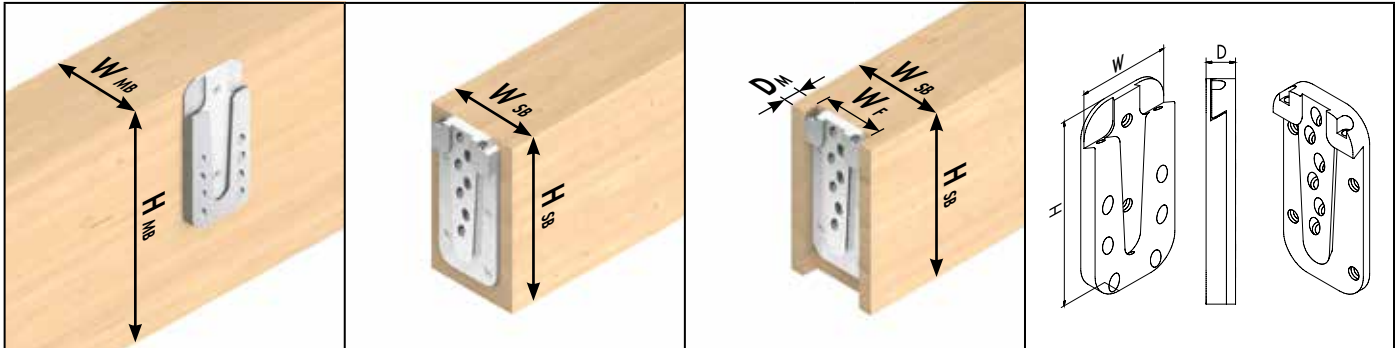

Symbolic illustrations: f.l.t.r. Main beam, secondary beam surface-mounted, secondary beam flush-mounted, connector dimensions

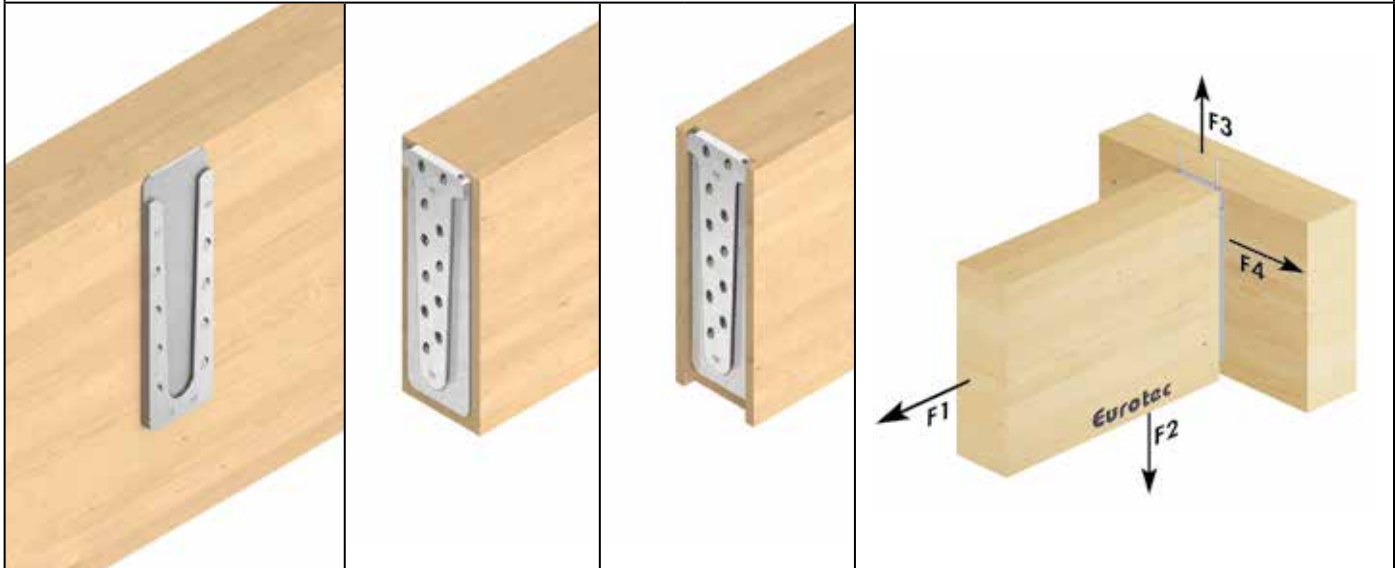

Art. no.	Name	Dimensions		PU*	Fully threaded screws ^{b)}					Fixing screws ^{b)}		
		W x H x D ^{a)}			Dimensions	n _{total}	In the main beam		In the secondary beam		Dimensions	n
		[mm]					[mm]	n _{90°}	n _{45°}	n _{90°}		
944888	Magnus L 110 x 380	110 x 380 x 19		4	8,0 x 120	25	4	8	2	11	4,8 x 60	2

* 1 connector consists of 2 individual parts

a) D= assembly thickness

b) Included in delivery

Art. no.	Name	Dimensions		Main beam		Secondary beam surface-mounted		Secondary beam flush-mounted		characteristic load-bearing capacity FR _k ^{d)}					
		W x H x D ^{a)}		min. W _{MB}	min. H _{MB}	min. W _{SB}	min. H _{SB}	min. W _{SB} ^{b)}	min. H _{SB}	W _M	D _M ^{c)}	F _{1,Rk}	F _{2,Rk}	F _{3,Rk}	F _{4,Rk}
		[mm]		[mm]	[mm]	[mm]	[mm]	[mm]	[mm]	[mm]	[mm]	[kN]	[kN]	[kN]	[kN]
944888	Magnus L 110 x 380	110 x 380 x 19		120	400	120	400	140	400	110	19	9,29	72,20	23,00	26,96

a) D= assembly thickness

b) Included in delivery

c) Recommended minimum width of the secondary beam with the connector flush-mounted

d) To make installation easier, it is advantageous to reduce the milling depth slightly, especially for larger wood dimensions.

e) Both beams softwood with a gross density of ρ_k= 380 kg/m³.

The specified characteristic values of the load-bearing capacity FR_k apply to the specified timber cross-sections, centred force application along the respective beam axis as well as connector installation flush with the top edge of the main and secondary beams. Calculation according to ETA 15/0761. All mechanical values provided should be viewed as subject to the assumptions that have been made and represent example calculations.

All values are calculated minimum values and are subject to typographical and printing errors.

The characteristic values of the load-bearing capacity FR_k should not be treated as equivalent to the max. possible load (the max. force). The characteristic values of the load-bearing capacity FR_k should be reduced to the design values FR_d in terms of the service class and the load duration class: FR_d= FR_k x k_{mod} / γ_M.

The characteristic load-bearing capacities for the L series were determined using 8 x 120 VG screws. Higher capacities can be achieved with longer screws (however, the minimum cross-sections of the supports also change)

Please note: These are planning aids. Projects must only be calculated by authorised persons.

MAGNUS L 110 X 580

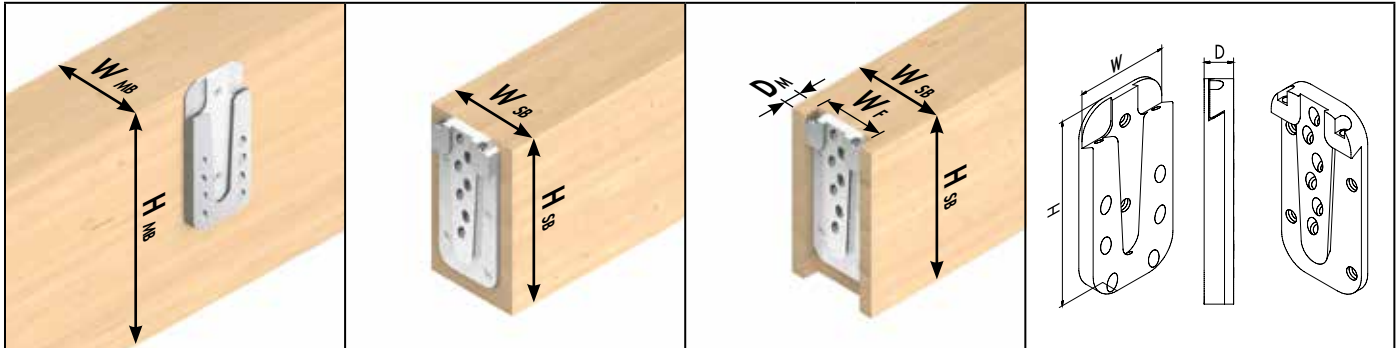

Symbolic illustrations: f.l.t.r. Main beam, secondary beam surface-mounted, secondary beam flush-mounted, connector dimensions

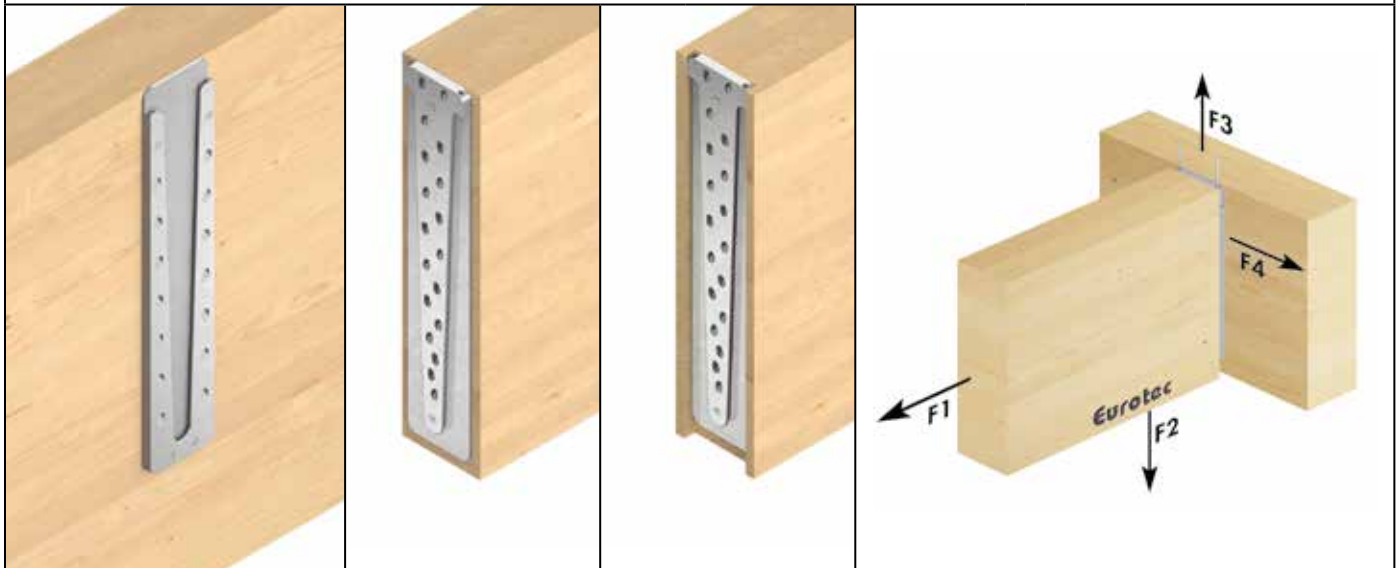

Art. no.	Name	Dimensions		PU*	Fully threaded screws ^{b)}					Fixing screws ^{b)}		
		W x H x D ^{a)}			Dimensions	n _{total}	In the main beam		In the secondary beam		Dimensions	n
		[mm]					[mm]	n _{90°}	n _{45°}	n _{90°}		
944889	Magnus L 110 x 580	110	580 x 19	4	8,0 x 120	38	4	14	2	18	4,8 x 60	2

* 1 connector consists of 2 individual parts

a) D= assembly thickness

b) Included in delivery

Art. no.	Name	Dimensions		Main beam		Secondary beam surface-mounted		Secondary beam flush-mounted			characteristic load-bearing capacity F _{Rk} ^{d)}				
		W x H x D ^{a)}		min. W _{MB}	min. H _{MB}	min. W _{SB}	min. H _{SB}	min. W _{SB} ^{b)}	min. H _{SB}	W _M	D _M ^{c)}	F _{1,Rk}	F _{2,Rk}	F _{3,Rk}	F _{4,Rk}
		[mm]		[mm]	[mm]	[mm]	[mm]	[mm]	[mm]	[mm]	[mm]	[kN]	[kN]	[kN]	[kN]
944889	Magnus L 110 x 580	110	580 x 19	120	600	120	600	140	600	110	19	9,29	126,35	23,00	43,29

a) D= assembly thickness

b) Included in delivery

c) Recommended minimum width of the secondary beam with the connector flush-mounted

d) To make installation easier, it is advantageous to reduce the milling depth slightly, especially for larger wood dimensions.

e) Both beams softwood with a gross density of ρ_k= 380 kg/m³.

The specified characteristic values of the load-bearing capacity F_{Rk} apply to the specified timber cross-sections, centred force application along the respective beam axis as well as connector installation flush with the top edge of the main and secondary beams. Calculation according to ETA 15/0761. All mechanical values provided should be viewed as subject to the assumptions that have been made and represent example calculations.

All values are calculated minimum values and are subject to typographical and printing errors.

The characteristic values of the load-bearing capacity F_{Rk} should not be treated as equivalent to the max. possible load (the max. force). The characteristic values of the load-bearing capacity F_{Rk} should be reduced to the design values F_{Rd} in terms of the service class and the load duration class: F_{Rd}= F_{Rk} x k_{mod} / γ_M.

The characteristic load-bearing capacities for the L series were determined using 8 x 120 VG screws. Higher capacities can be achieved with longer screws (however, the minimum cross-sections of the supports also change)

Please note: These are planning aids. Projects must only be calculated by authorised persons.



ECS SOFTWARE



The Eurotec ECS calculation software allows you to create verifiable calculation aids according to ETA-15/0761 and EN 1995 (Eurocode 5) in an extremely short space of time.



Download now www.eurotec.team/service

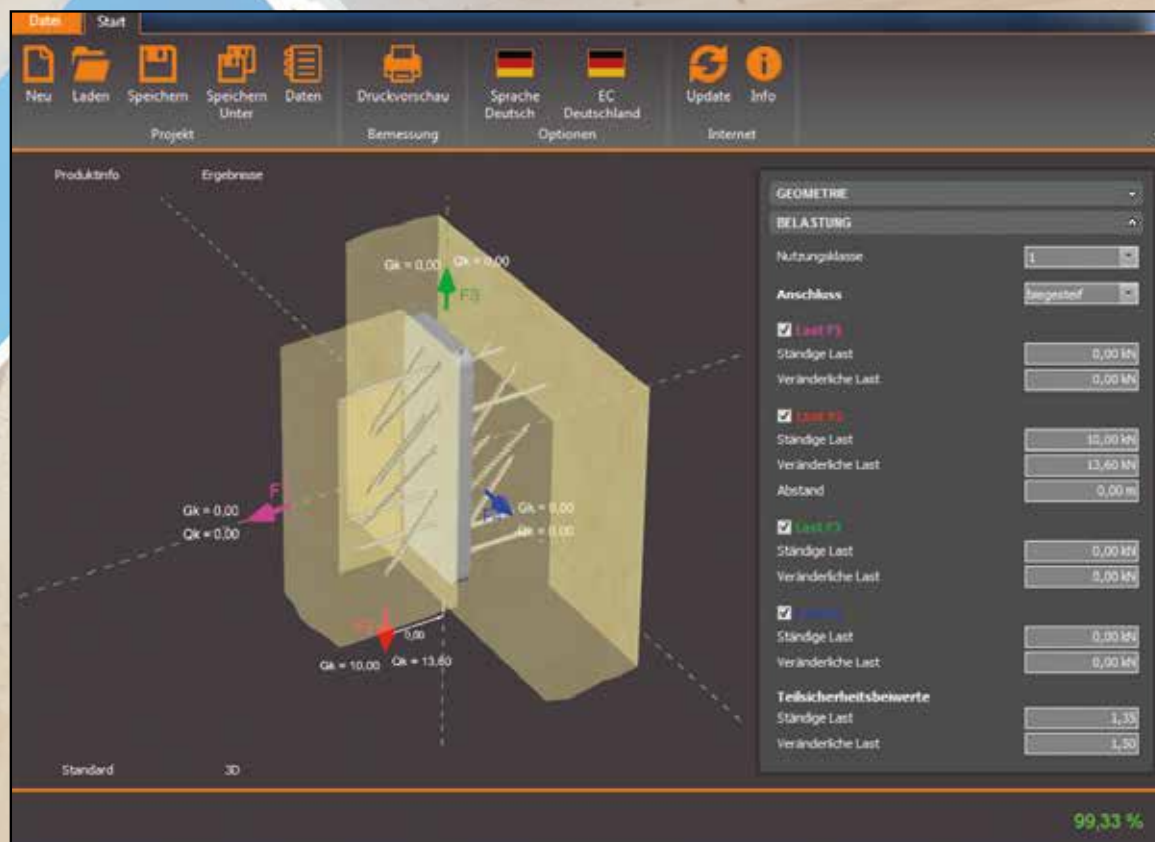

- **Ease to use**
- **Reliable planning**
- **Optimisation**

by phone 02331 6245-444 · by fax 02331 6245-200 · by e-mail technik@eurotec.team

Please contact our technical department or use the free calculation services in the service section of our website.

Contact

Trader: _____	Contractor: _____
Contact Person: _____	Contact Person: _____
email: _____	Phone: _____
Project: _____	email: _____

Project details

Main Beam

Width: _____ mm

Height: _____ mm

Strength class: _____
(e.g. C24, GL24h etc.)

Secondary Beam

Width: _____ mm

Height: _____ mm

Strength class: _____
(e.g. C24, GL24h etc.)

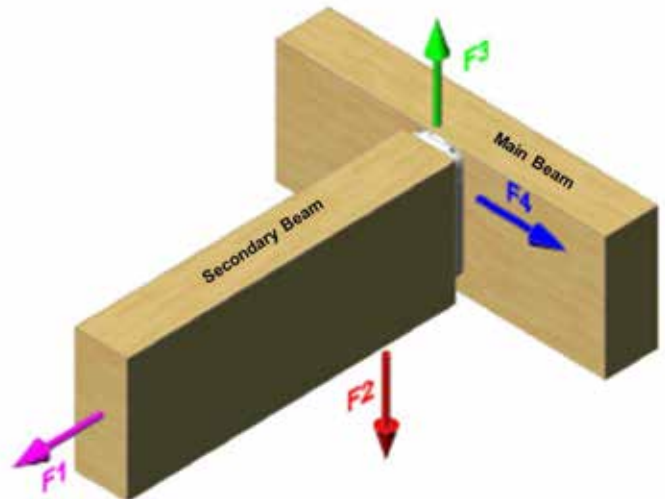

Loads (Characteristic values)

Load duration class

Permanent Long Medium Short

Installation

Surface assembly

Embedded in secondary beam

Embedded in main beam

F1 – Proportion of permanent load: _____ kN
 – Proportion of variable load: _____ kN

F2 – Proportion of permanent load: _____ kN
 – Proportion of variable load: _____ kN

F3 – Proportion of permanent load: _____ kN
 – Proportion of variable load: _____ kN

F4 – Proportion of permanent load: _____ kN
 – Proportion of variable load: _____ kN

Selection of Magnus

XS 30 x 30 S 50 x 60/80/100 M 70 x 120/140/160/180 L 110 x 220/260/300/340/380/580

T-PROFILE

FOR HIDDEN ALUMINIUM CONNECTIONS

ADVANTAGES

- Hole pattern specially for Angle-bracket screw $\varnothing 5,0 \times 50$ mm
- Ideal for the timber-concrete connection with the Rock concrete screw $\varnothing 7,5$
- Creates a hidden connection
- No need of predrilling in combination with the EST dowel bar

DESCRIPTION

The self-drilling EST-Dowel bar $\varnothing 7,5$ can be connected to the T-profile without predrilling. The T-profile has a hole pattern for the Angle-bracket screw $5,0 \times 5,0$ mm. It can also be used together with the Rock concrete screw $\varnothing 7,5$ for the timber-concrete connection. Can be used in service classes 1 and 2 according to DIN EN 1995.

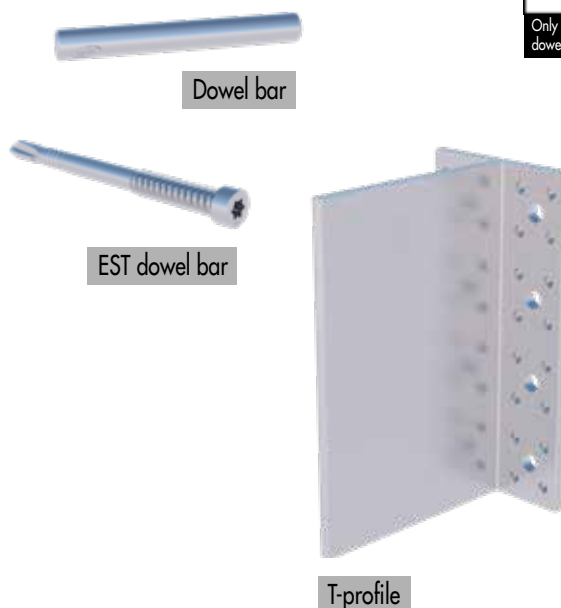

Suitable for use with:
 KonstruX (p. 80), Angle-bracket screw (p.108)
 Paneltwistec (p. 110), Rock concrete screw (p. 76)
 EST dowel bar (p.70), Dowel bar (p.71)

Art. no.	Name	Dimensions [mm] ^{a)}	Material	Material thickness [mm]	PU
975652	T-profile	115 x 2000 x 80	Aluminium	6	1

a) Height x Length x Width

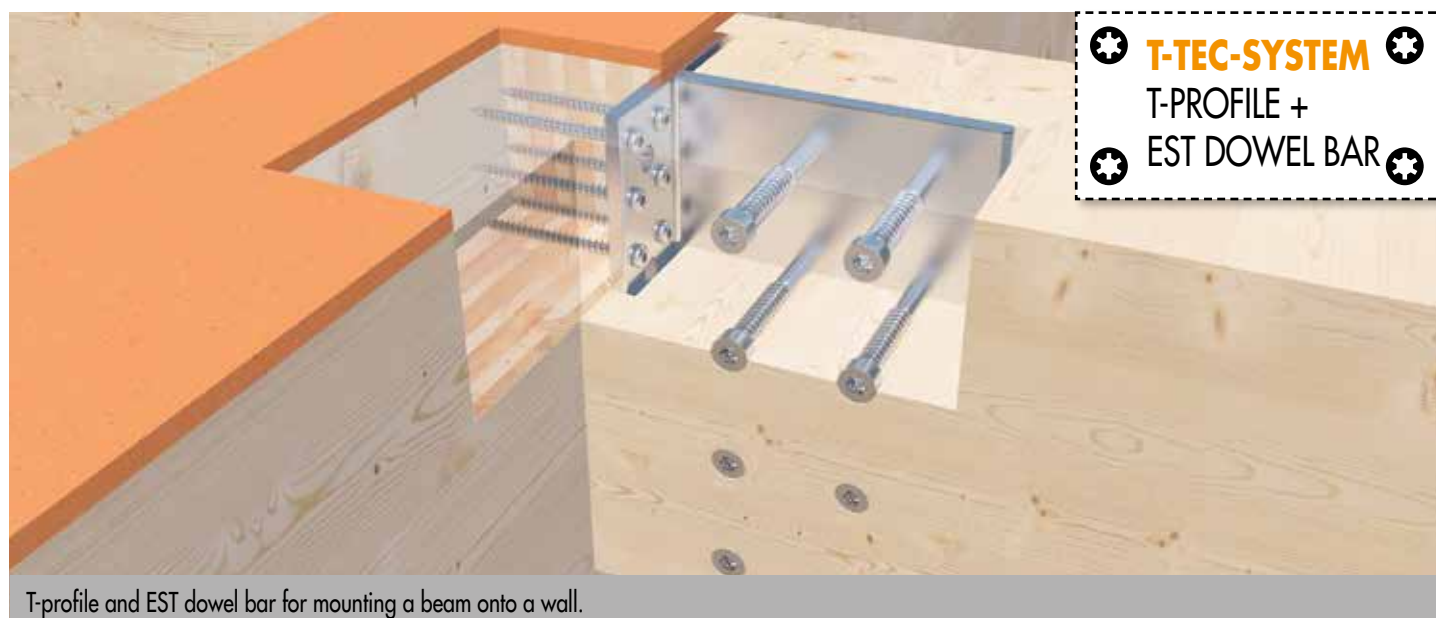

T-profile and EST dowel bar for mounting a beam onto a wall.



Individual cutting of the profile to length



No need of predrilling with the EST dowel bar

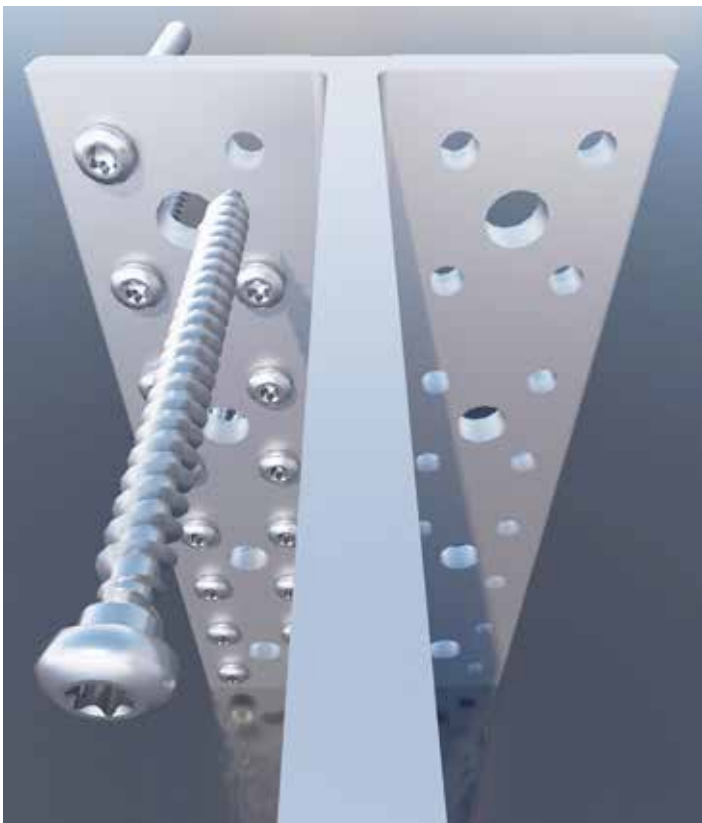

Hole pattern with the Angle-bracket screw

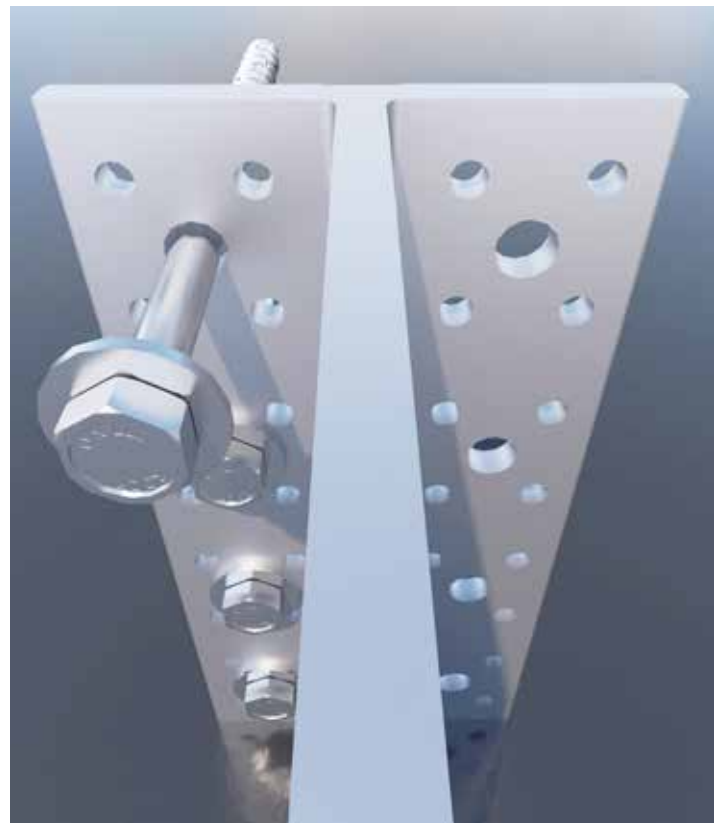

Hole pattern with the Rock concrete screw

EST DOWEL BAR

DOUBLE-THREADED SCREW WITH CYLINDER HEAD

Eurotec's self-drilling EST dowel bar is a double-threaded screw with an innovative arrow drill and a specifically developed chip-removing groove. Ideally suited for hidden connections in combination with our T-profile. The double-threaded screw has a cylinder head with TX drive. The special geometry of the arrow drill ensures a lower splitting effect when screwing in. The chip-removing groove ensures optimised screwing-in behaviour.

EST dowel bar

Suitable
for
T-profile



Art. no.	Dimensions [mm]	Thread length [mm]	Drive	PU
800304	7,5 x 73	27/0	TX40 ●	50
800291	7,5 x 93	27/8,5	TX40 ●	50
800305	7,5 x 113	36/12,5	TX40 ●	50
800306	7,5 x 133	36/12,5	TX40 ●	50
800307	7,5 x 153	36/12,5	TX40 ●	50
800287	7,5 x 173	36/12,5	TX40 ●	50
800288	7,5 x 193	36/12,5	TX40 ●	50
800289	7,5 x 213	36/12,5	TX40 ●	50
800290	7,5 x 233	36/12,5	TX40 ●	50

ADVANTAGES / PROPERTIES

- Corrosion resistance
- Can be used in service classes 1 and 2 according to DIN EN 1991
- Good resistance to mechanical stresses
- No pilot-drilling necessary
- With innovative arrow drill
- No hammering of the screws thanks to TX-drive
- Optimum chip-removing groove in the thread
- Suitable for timber and aluminum

TECHNICAL DRAWING



APPLICATION COMBINATION EST DOWEL BAR AND T-PROFILE



DOWEL BAR



The rod dowel is a cylindrical bolt that has a phase at both ends for easier insertion. The rod dowel is suitable for both timber-timber joints and timber-steel joints. It is ideal for combination with our T-profile. The rod dowel is available in different diameters and lengths for an extremely wide range of applications. Please note the product table for this purpose.

Dowel bar

Suitable
for
T-profile



ADVANTAGES

- Easy to use
- Can be combined with the Eurotec T-profile and all common T-profiles
- Can be used in service classes 1 and 2

INSTRUCTIONS FOR USE

During use, ensure that the distances from the axis and edge are observed. A drilling template must be used for the holes.

Art. no.	Dimensions [mm]	PU
800212	12 x 98	50
800213	12 x 118	50
800214	12 x 138	50
800215	12 x 158	50
800216	12 x 178	50
800217	12 x 198	50
800218	12 x 218	50
800219	12 x 238	50
800220	12 x 258	50
800221	12 x 278	50
800222	12 x 298	50
800223	16 x 138	50
800224	16 x 158	50
800225	16 x 178	50
800226	16 x 198	50
800227	16 x 218	50
800228	16 x 238	50
800229	16 x 258	50
800230	16 x 278	50
800231	16 x 298	50
800241	16 x 340	50
800243	16 x 480	25
800232	16 x 500	25
800242	16 x 580	25
800233	20 x 158	50
800234	20 x 178	50
800235	20 x 198	50
800236	20 x 218	50
800237	20 x 238	50
800238	20 x 258	50
800239	20 x 278	50
800240	20 x 298	50

TECHNICAL DRAWING

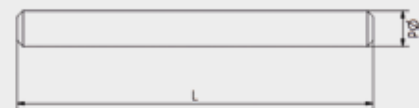

APPLICATION COMBINATION DOWEL BAR AND T-PROFILE



HIDDEN GROUND ANCHOR

NEW
to our product range

ADVANTAGES

- After installation of the floor, the hidden ground anchor is no longer visible
- Dowel bar can easily be covered with thin wooden plates
- Easy insertion of the dowels, as the ground anchor is easy to drill through

INSTRUCTIONS FOR USE

The later fastening point for the hidden ground anchor is prefabricated in the factory. The hidden ground anchor is screwed onto the wooden floor at the appropriate place. Then the wall can be placed over it. Through the groove in the wall, the hidden ground anchor can still be seen exactly as far as necessary. In the assembled state, the holes for the Dowel bar are drilled to ensure troublefree assembly. After the installation of the floor covering, the hidden ground anchor is no longer visible.

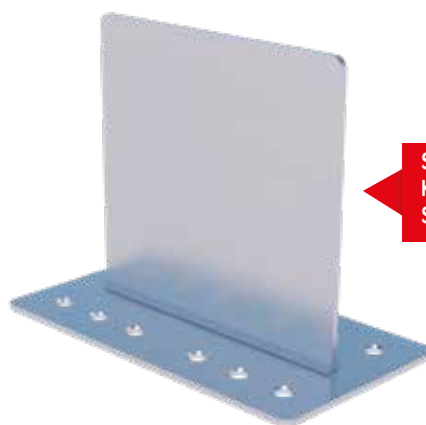

Suitable for use with:
KonstruX (S. 80), Dowel bar (p. 71)
SonoTec Angular Decoupler (p. 156)



6 dowel bars are required
for fastening

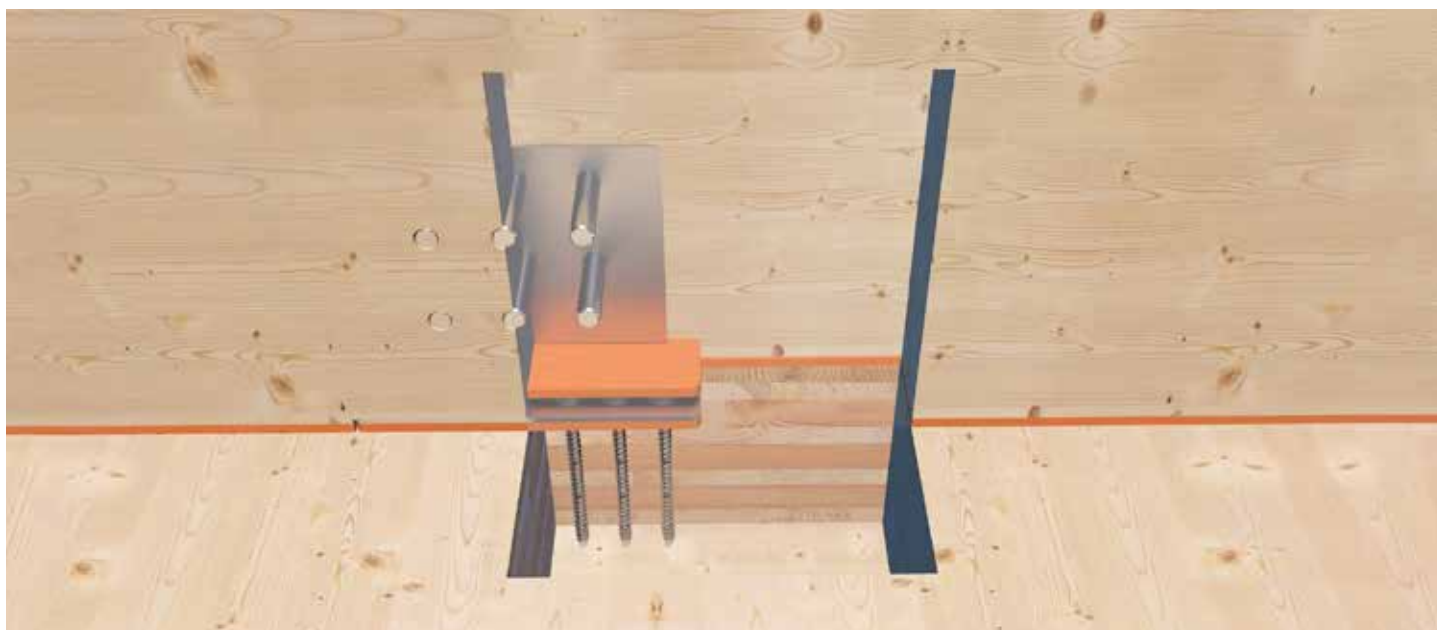

Hidden ground anchor for hidden fastening of a wall onto wooden floor.

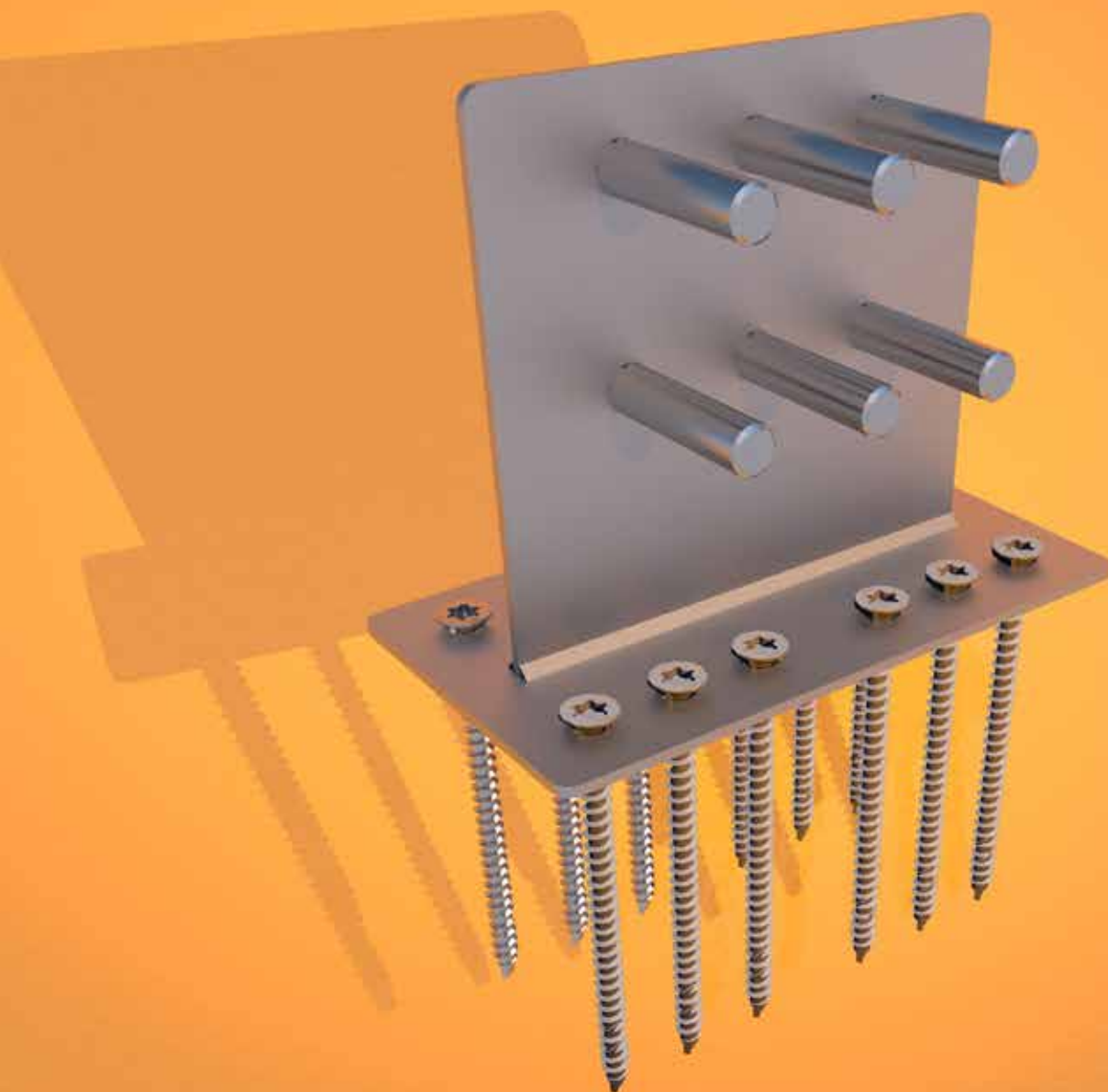

One of our new products is the **hidden ground anchor**. As the name suggests, this connector is no longer visible after the floor covering has been installed, because it is fully recessed into the wall.

⚙ **HIDDEN GROUND** ⚙
ANCHOR -
⚙ **COMING SOON!** ⚙

Eurotec[®]

Screws

2010





Screws

Rock concrete screw	76 – 79
KonstruX fully threaded screw	80 – 107
Angle-bracket screw	108 – 109
Paneltwistec	110 – 123
SawTec	124 – 127
Topduo roofing screw	128 – 133

ROCK CONCRETE SCREW

FOR FASTENING TO CONCRETE WITHOUT PLUGS



ADVANTAGES

- No spreading effect due to small center and edge distances
- Immediately loadable - therefore no waiting times
- Small borehole depths and small drill hole diameters
- Can be used for components that are constantly exposed to weathering in outdoor areas

PROPERTIES

- Highest power transmission
- High-strength screw steel
- Extremely complex annealing process
- Special thread

INSTRUCTIONS FOR USE

To insert the screw, the core hole is drilled first. The drill hole has to be cleaned, the chips have to be removed and finally the attachment part has to be fixed with the screw in the drill hole. The Rock concrete screw is developed for use in wood, concrete and stone.

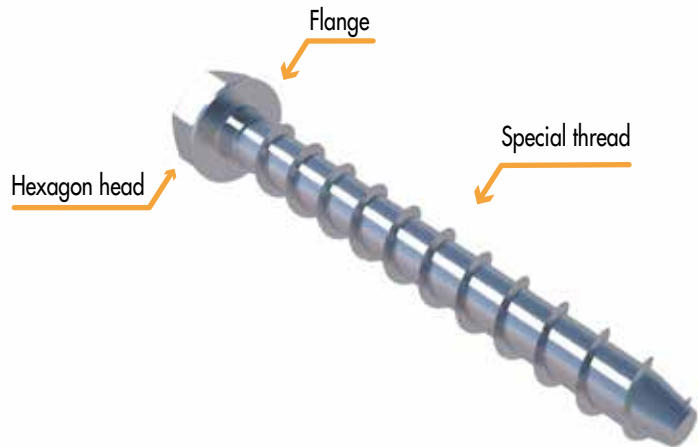

Rock concrete screw embedded in a sill plate.

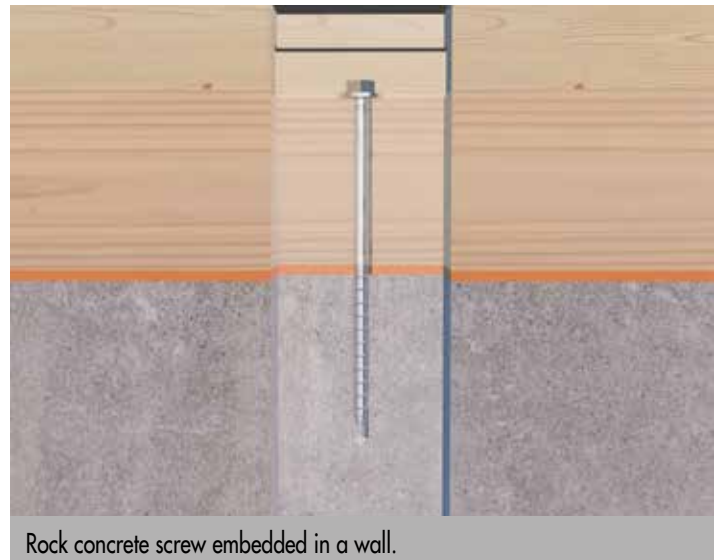

Rock concrete screw embedded in a wall.

Rock concrete screw

Hexagonal with flange, galvanised steel



Art. no.	Dimensions [mm]	Head	PU
110227*	7,5 x 40	SW13	100
110228*	7,5 x 50	SW13	100
110229	7,5 x 60	SW13	100
110230	7,5 x 80	SW13	100
110231	7,5 x 100	SW13	100
110232*	10,5 x 50	SW15	100
110233*	10,5 x 60	SW15	100
110234	10,5 x 80	SW15	100
110235	10,5 x 100	SW15	100
110236	10,5 x 120	SW15	100
110237	10,5 x 140	SW15	100
110238	10,5 x 160	SW15	100

*Screws not regulated by ETA-15/0886

Rock concrete screw

Hexagonal with flange, special coated



Art. no.	Dimensions [mm]	Head	PU
110253	16,5 x 115	SW18	25
110254	16,5 x 135	SW18	25
110255	16,5 x 160	SW18	25

Rock concrete screw

Hexagonal, galvanised steel



Art. no.	Dimensions [mm]	Head	PU
110338*	7,5 x 40	SW13	100
110339*	7,5 x 50	SW13	100
110340	7,5 x 60	SW13	100
110341	7,5 x 80	SW13	100
110342*	10,5 x 60	SW15	100
110343	10,5 x 80	SW15	100
110344	10,5 x 100	SW15	100
110345	10,5 x 120	SW15	100
110346	10,5 x 140	SW15	100
110347	10,5 x 160	SW15	100
110336*	12,5 x 60	SW17	100
110337	12,5 x 80	SW17	100
110327	12,5 x 100	SW17	100
110328	12,5 x 120	SW17	100
110329	12,5 x 140	SW17	100
110330	12,5 x 160	SW17	50
110331	12,5 x 180	SW17	50
110332	12,5 x 200	SW17	50
110333	12,5 x 240	SW17	50
110334	12,5 x 280	SW17	50
110335	12,5 x 320	SW17	50

*Screws not regulated by ETA-15/0886

Rock concrete screw

Countersunk head, galvanised steel



Art. no.	Dimensions [mm]	Drive	PU
110348*	7,5 x 40	TX40 ●	100
110349	7,5 x 60	TX40 ●	100
110350	7,5 x 80	TX40 ●	100
110351	7,5 x 100	TX40 ●	100
110352	7,5 x 120	TX40 ●	100
110353	7,5 x 140	TX40 ●	100
110354	7,5 x 160	TX40 ●	100

*Screws not regulated by ETA-15/0886

TECHNICAL INFORMATION ROCK CONCRETE SCREW

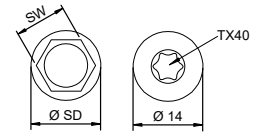
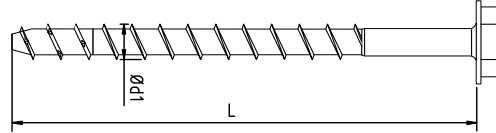
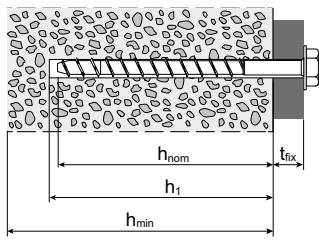

Dimension Ø x Length Ød1 x L [mm]	Ø Head WAF/dk [mm]	Ø Flange SD [mm]	Minimum part thickness h _{min} [mm]	Attachment thickness t _{fix} [mm]	Screwing depth h _{nom} [mm]	Characteristic values of load-bearing capacity for tensile or shear loading ^{a)}				Drill diameter (Concrete) d ₀ [mm]	Depth of drill hole h ₁ [mm]	Diameter of drill hole (attachment) d _f [mm]	min. Edge/ centre distance s _{min} /c _{min} [mm]
						Tensile load-bearing capacity (non-cracked concrete, C20/25) N _{Rk,p} [kN]	Tensile load-bearing capacity (cracked concrete, C20/25) N _{Rk,p} [kN]	Shear load-bearing capacity (Steel) V _{Rk,s} ^{b)} [kN]	Bending moment (Steel) M _{Rk,s} ^{b)} [Nm]				

Rock, hexagonal with flange

7,5 x 60	SW13	16,5	100	5	55	6,0	3,0	11,0	19,0	6	70	9	40
7,5 x 80				25									
10,5 x 80				5									
10,5 x 100	SW15	17,5	160	25	75	6,0	3,0	22,0	51,0	9	90	12	55
10,5 x 120				45									
10,5 x 140				65									
10,5 x 160				85									
16,5 x 115	SW18	30,5	175	5	110	40,0	30,0	57,9	235,9	14	130	18	100
16,5 x 135				25									
16,5 x 160				50									

Rock, hexagonal

7,5 x 60	SW13	n/a	100	5	55	6,0	3,0	11,0	19,0	6	70	9	40
7,5 x 80				25									
10,5 x 80				5									
10,5 x 100	SW15	n/a	160	25	75	6,0	3,0	22,0	51,0	9	90	12	55
10,5 x 120				45									
10,5 x 140				65									
10,5 x 160				85									
12,5 x 80	SW17	n/a	200	5	75	25,0	12,0	35,0	98,0	10	90	14	65
12,5 x 100				5									
12,5 x 120				25									
12,5 x 140	SW17	n/a	200	45	95	25,0	12,0	35,0	98,0	10	110	14	65
12,5 x 160				65									
12,5 x 180				85									
12,5 x 200				105									
12,5 x 240				145									
12,5 x 280				185									
12,5 x 320	225												

Rock, countersunk head

7,5 x 60	14,0	n/a	100	5	55	6,0	3,0	11,0	19,0	6	70	9	40
7,5 x 80				25									
7,5 x 100				45									
7,5 x 120				65									
7,5 x 140				85									
7,5 x 160				105									

Setting tool: Electrical tangential impact wrench, max. power rating T_{max} according to manufacturer's data, recommended T_{max}: 250 Nm for Rock 7,5 x L; 450 Nm for Rock 10,5 x L and 12,5 x L and 16,5 L.

Note: A higher max. torque of the setting tool can lead to destruction of the drilling hole or damage to the screw.

Assembly with torque wrench: Recommended installation torque T_{inst}: 20 Nm for Rock 7,5 x L; 40 Nm for Rock 10,5 x L and 120 Nm for 16,5 x L.

a) The calculation for a joint is to be performed according to ETAG-001 Annex C. b) Partial safety factors: γ_{M_{s,V}}=1,5; γ_{M_{s,M}}=1,5.

Please note: These are planning aids. Projects must only be calculated by authorised persons.

by phone 02331 6245-444 · by fax 02331 6245-200 · by e-mail technik@eurotec.team

Please contact our technical department or use the free [calculation services](#) in the service section of our website.

Contact

Trader:	_____	Contractor:	_____
Contact Person:	_____	Contact Person:	_____
e-mail:	_____	Phone:	_____
Project:	_____	e-mail:	_____

Project details

Concrete

Strength category: _____
 (if known; min. C20/25)

Construction component: _____
 (e.g. strip footing, floor slab, wall, ceiling, etc.)

Component thickness h: _____ mm

Attachment

Steel Wood _____
 strength class of wooden attachment

Attachment thickness: _____ mm

Diameter of through hole: _____ mm

Loads (rated values) _____ mm

Normal force along X axis: N_d : _____ kN

Shear force along Y axis: $V_{y,d}$: _____ kN

Shear force along Z axis: $V_{z,d}$: _____ kN

Moment around X axis: $M_{x,d}$: _____ kNm

Moment around Y axis: $M_{y,d}$: _____ kNm

Moment around Z axis: $M_{z,d}$: _____ kNm

A detailed sketch of the joint must be enclosed with the inquiry, stating the following details:

- Geometry of concrete and attachment
- Edge and centre distances C and S
- Position of attachment relative to concrete component
- Position (and angle, where applicable) of force application point on the attachment

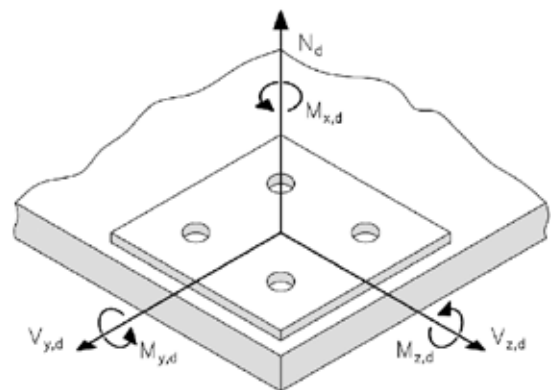
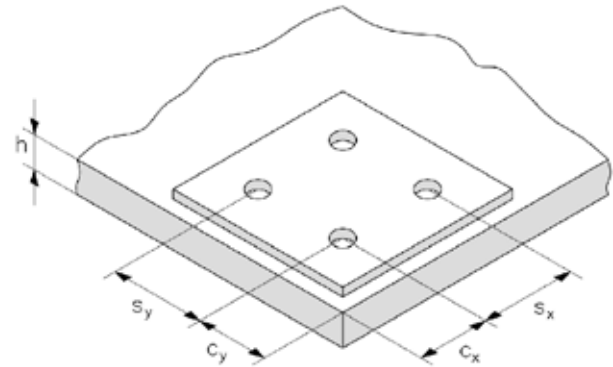

Screw selection

<input type="checkbox"/> Ø 7,5 mm countersunk head	<input type="checkbox"/> Ø 10,5 mm hex head	<input type="checkbox"/> Ø 12,5 mm hex, flange
<input type="checkbox"/> Ø 7,5 mm hex head, flange	<input type="checkbox"/> Ø 7,5 mm hex head	<input type="checkbox"/> Ø 10,5 mm hex head, flange
<input type="checkbox"/> Ø 10,5 mm hex head, flange	<input type="checkbox"/> Ø 12,5 hex head, flange	

KONSTRUX FULLY THREADED SCREW

THE HIGH-PERFORMANCE SOLUTION FOR NEW CONSTRUCTION AND REFURBISHMENT



ADVANTAGES

- High extraction resistance
- Strong joints
- Maximisation of the load-bearing capacity
- A time- and cost-saving alternative
- Hidden connections
- No pre-drilling required according to approval / ETA (recommended from screw lengths ≥ 245 mm)

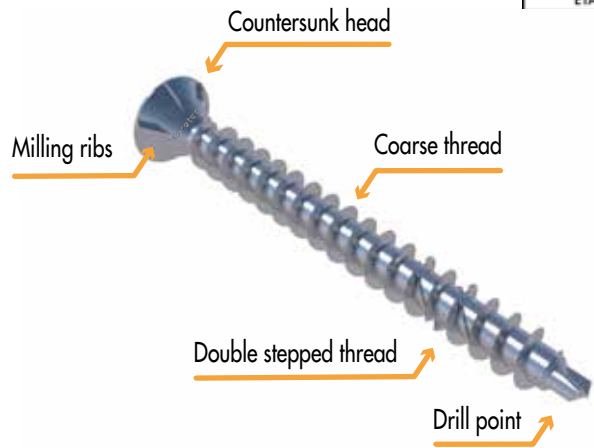

PROPERTIES

- Maximum load transmission
- High fire-resistance
- No thermal bridges

INSTRUCTIONS FOR USE

KonstruX fully threaded screws maximize the load-bearing capacity of a connection due to the high thread extraction resistance in both components. When using partially threaded screws, the significantly lower head pull-through resistance in the attachment part limits the load-bearing capacity of the connection. KonstruX fully threaded screws provide a cost-saving alternative to traditional connectors or timber connectors such as joist shoes and joist girders.

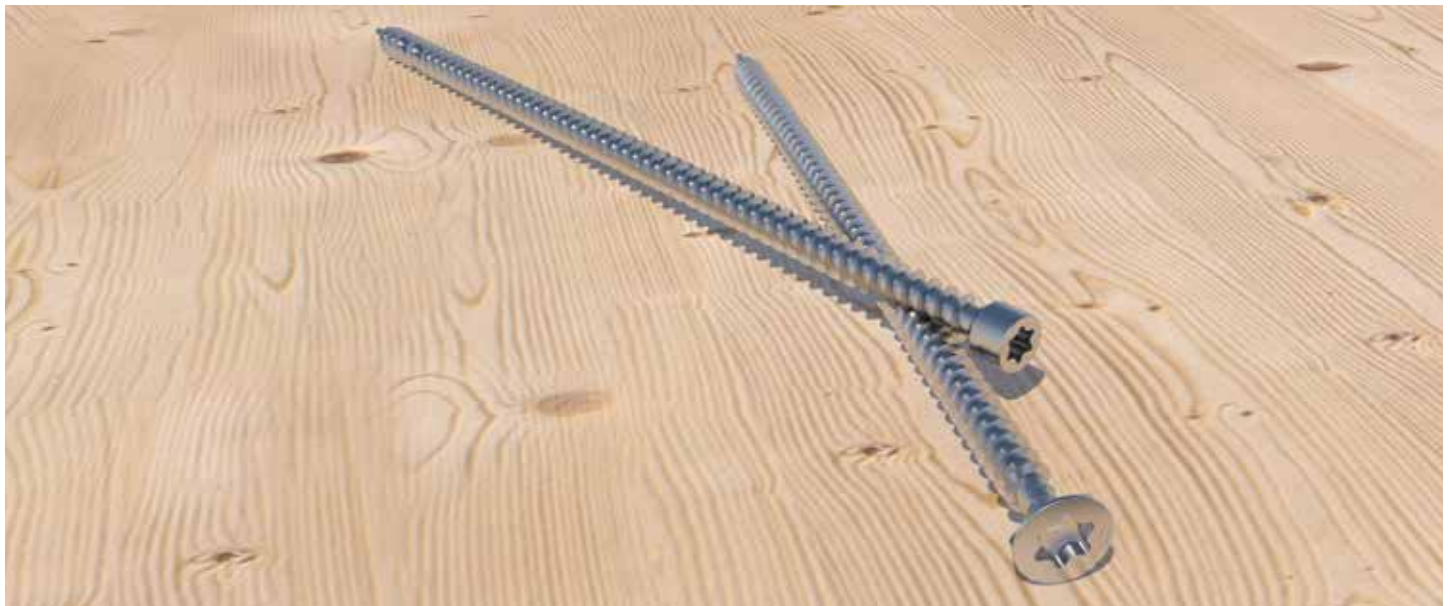
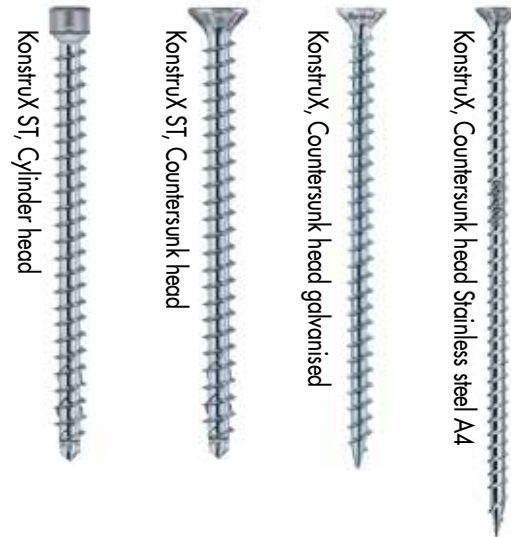

KonstruX countersunk head and KonstruX cylinder head.

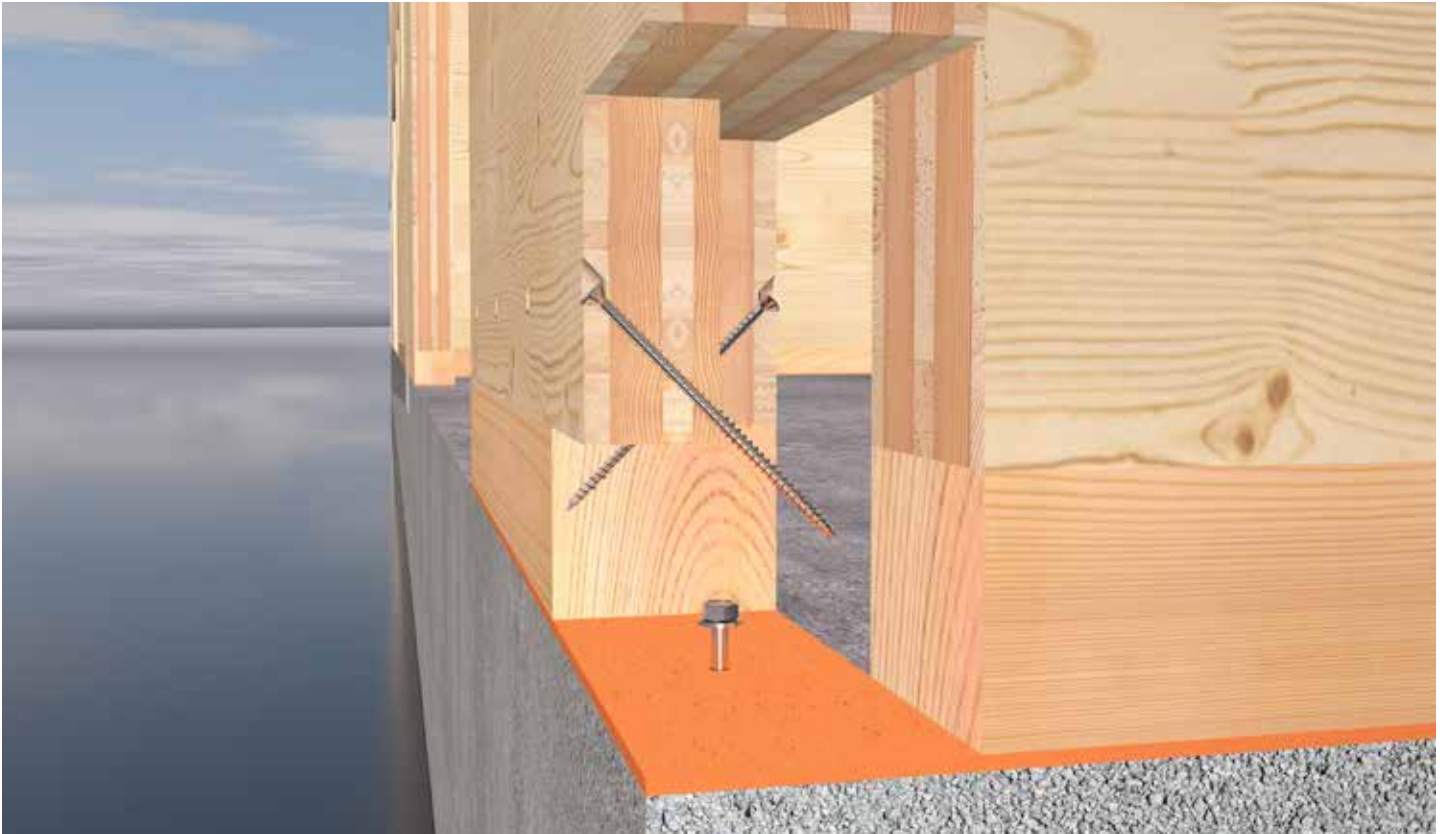

KonstruX in order to connect a wall with a sill plate.

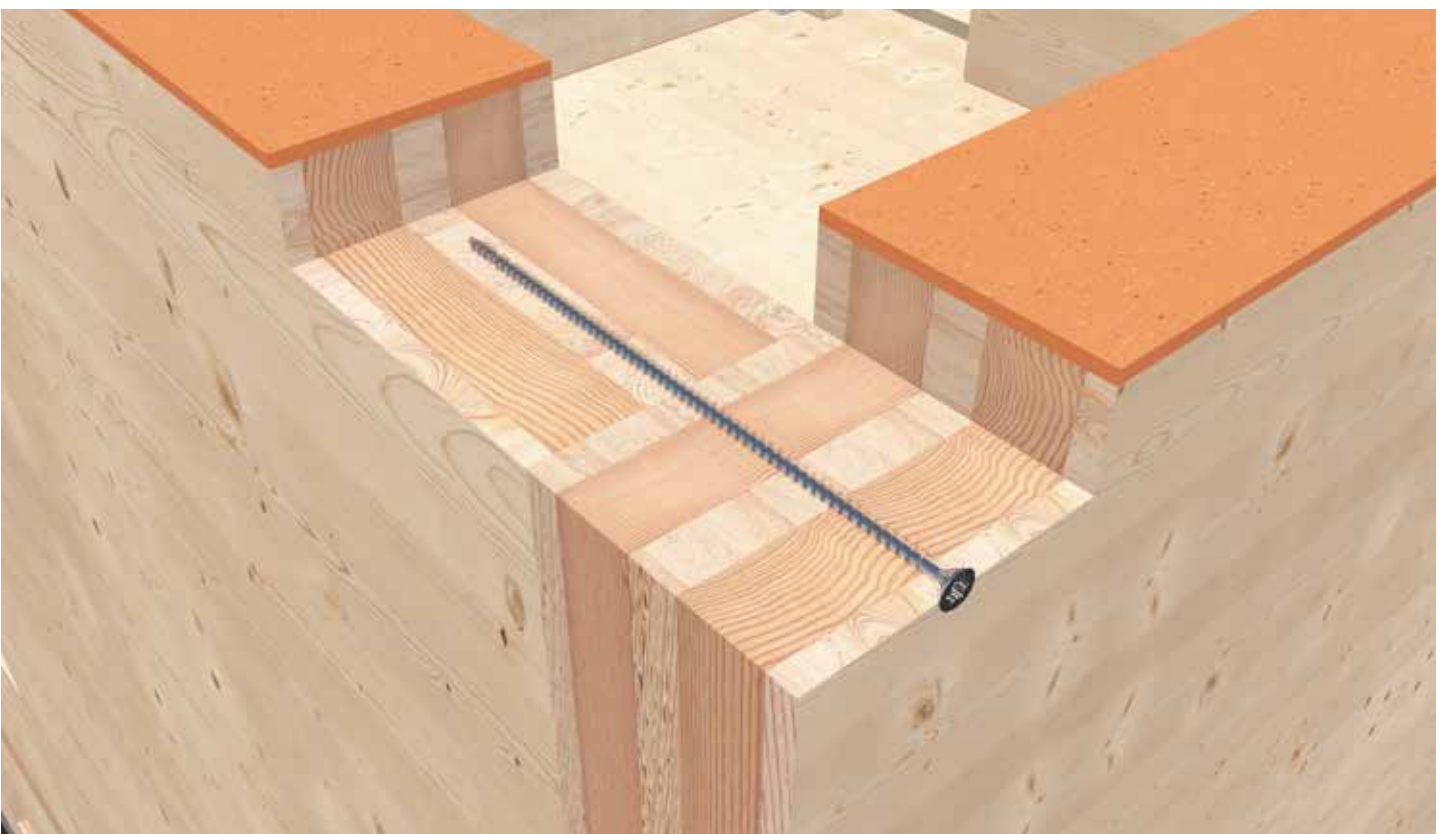

KonstruX in order to connect two walls with each other.



Connection of a wall and a support for the ceiling joist.

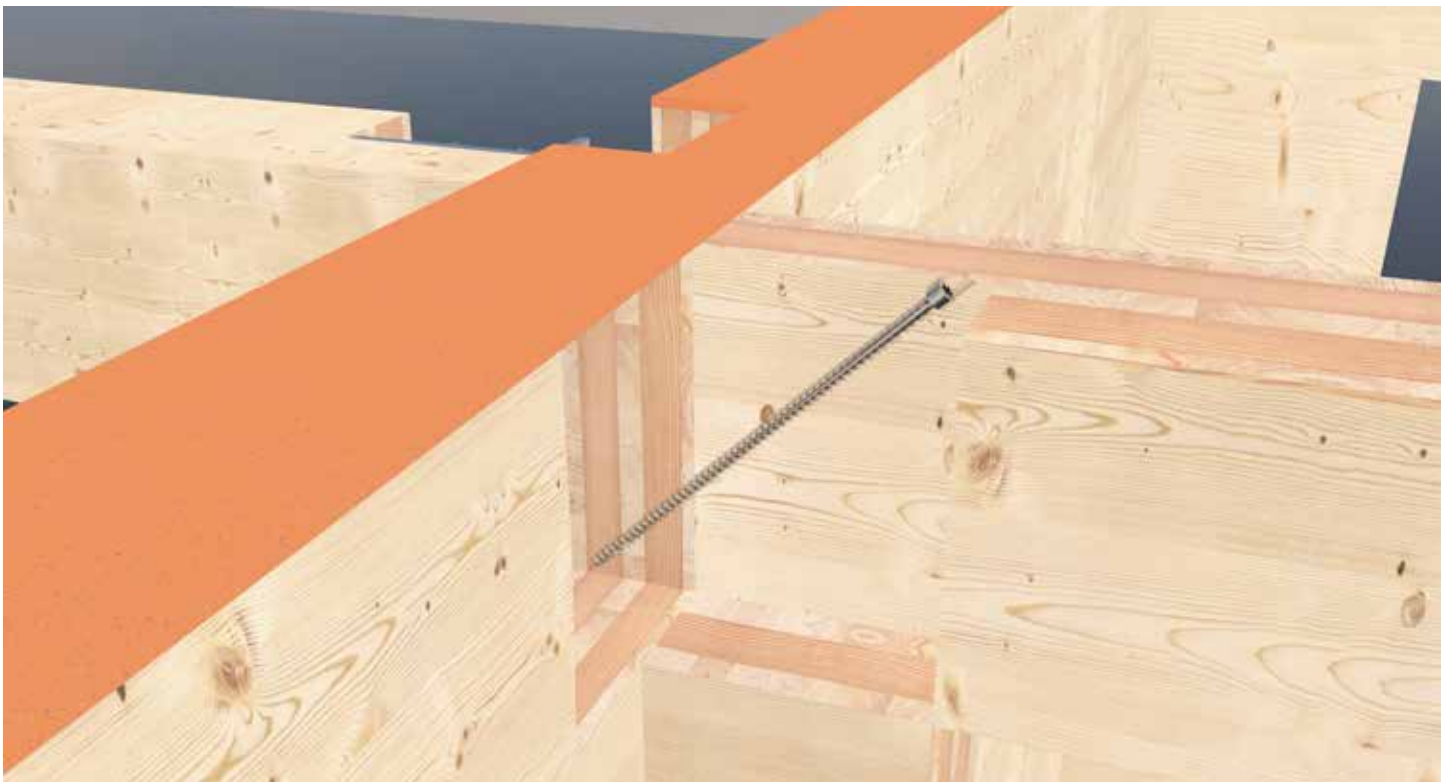

Connection of a wall and a beam for the ceiling joist.

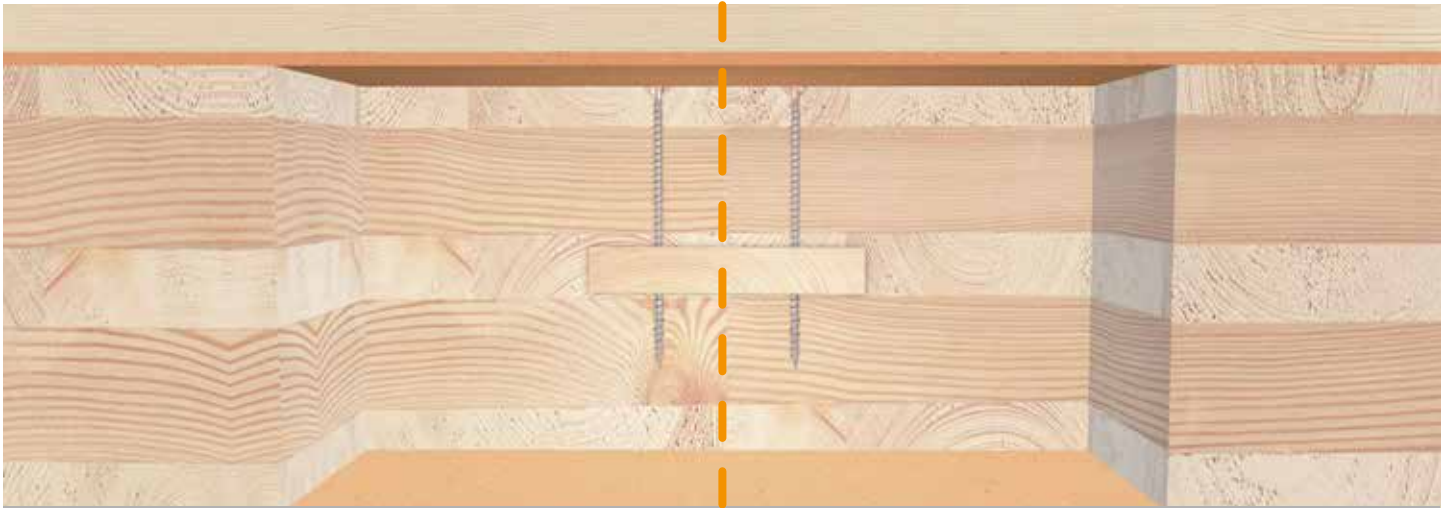

Connection of ceiling elements through internal push board.

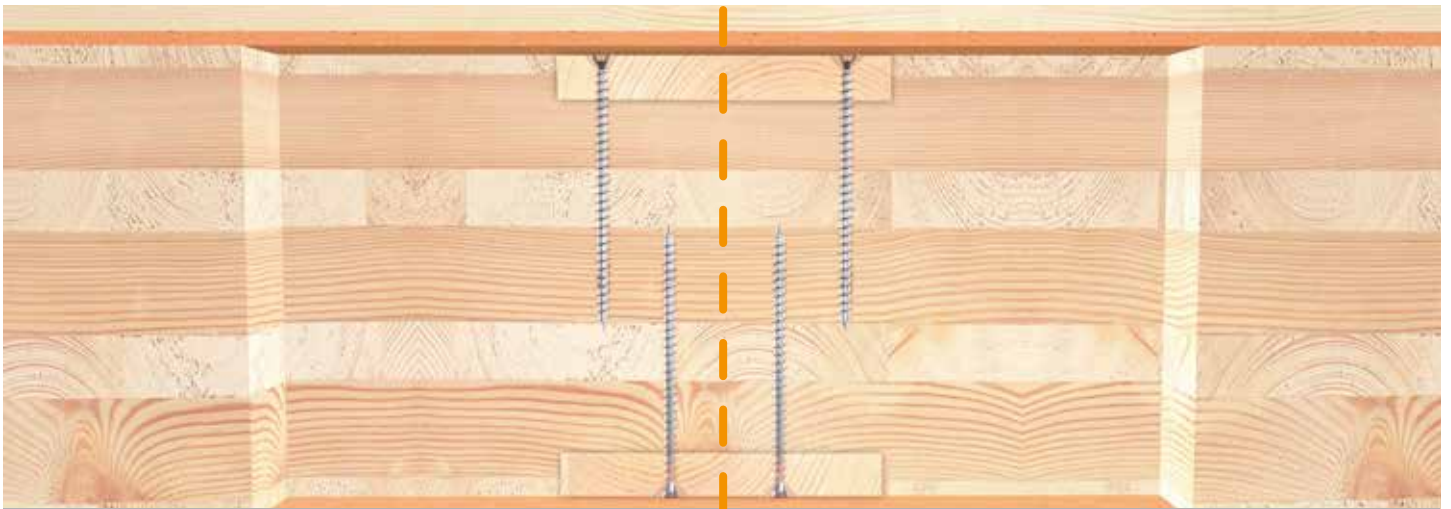

Connection of ceiling elements through double push board.

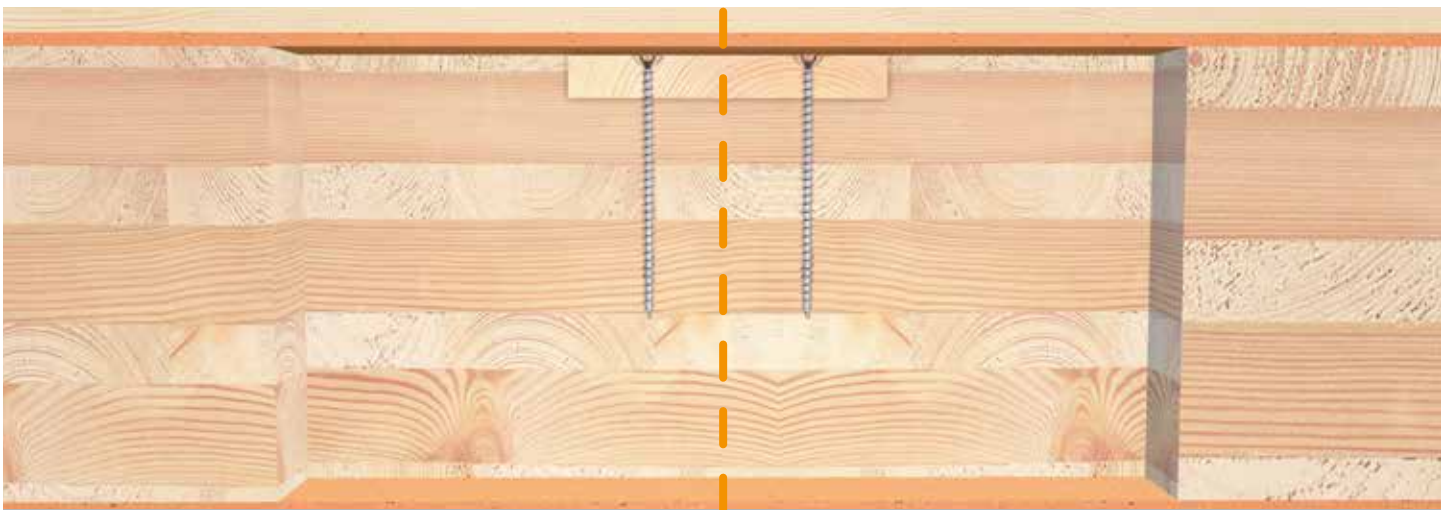

Connection of ceiling elements through upper push board.

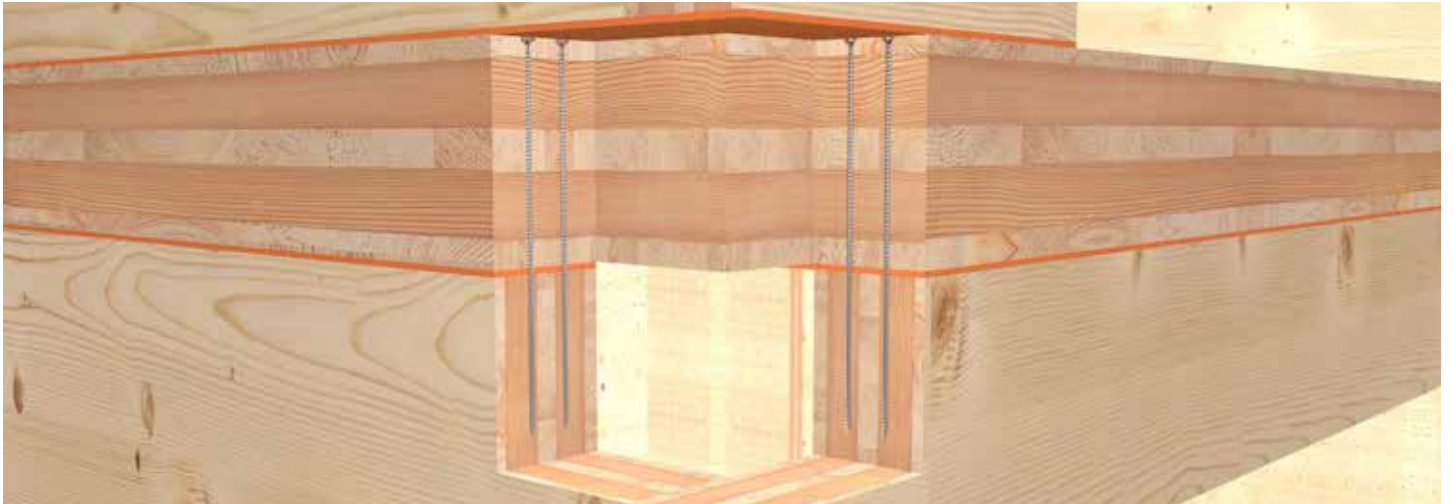

Connection of wall- and ceiling elements.

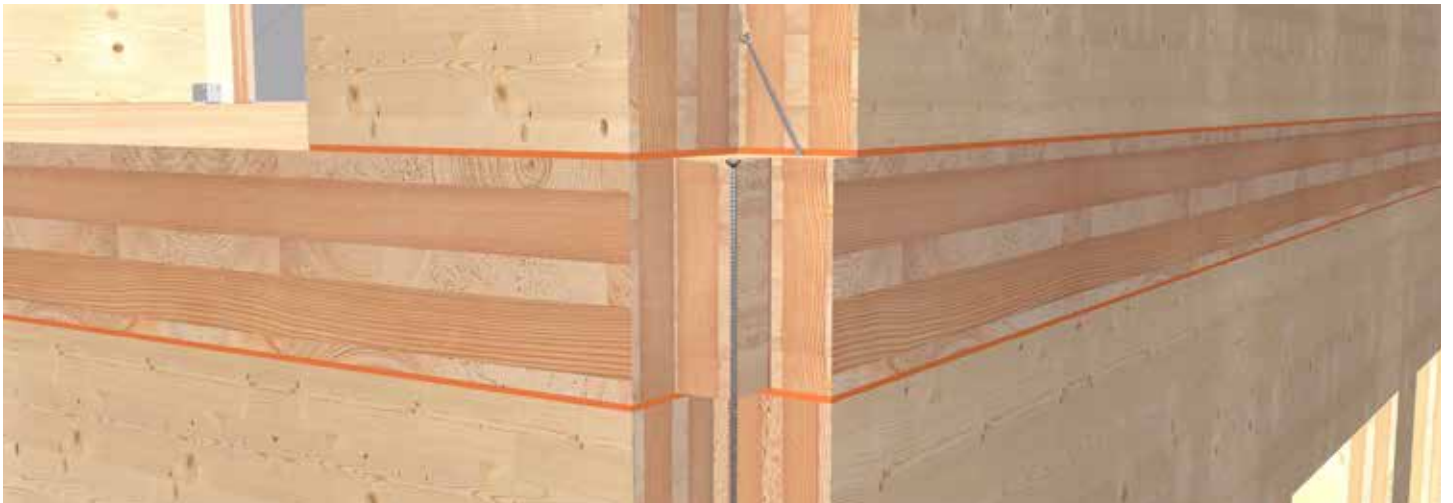

Connection of a wall with the wooden floor of the upper level.



Connection of roof- and wall elements.

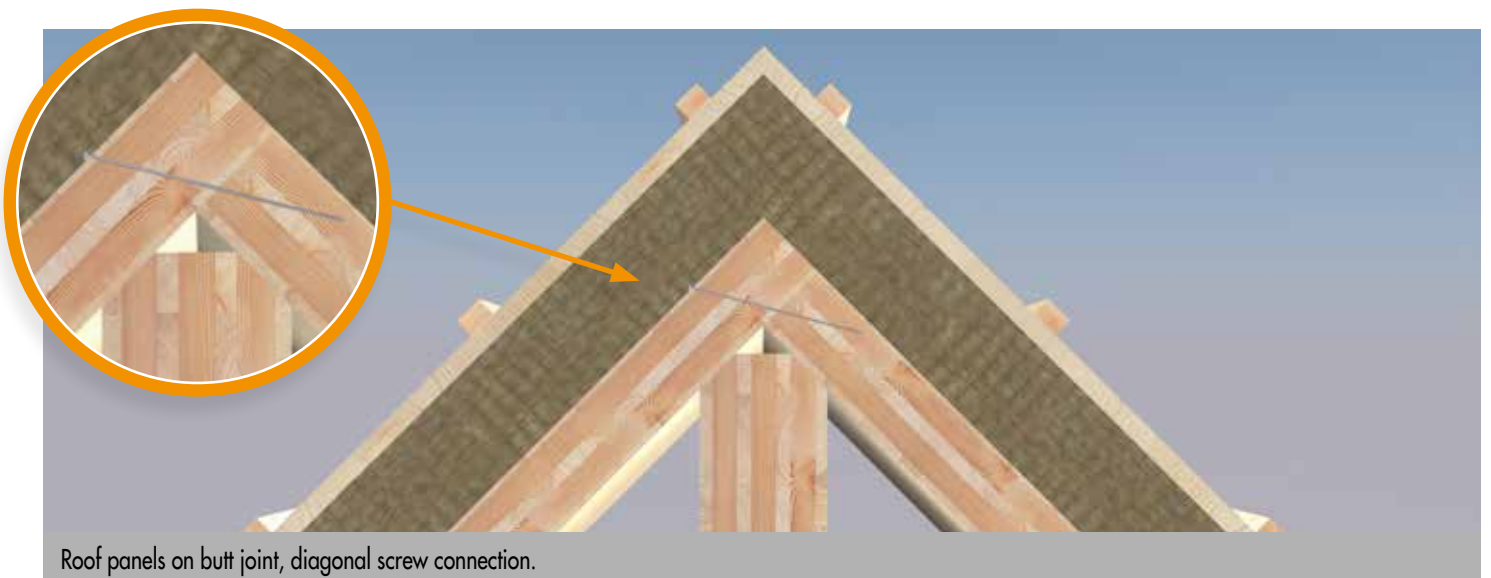
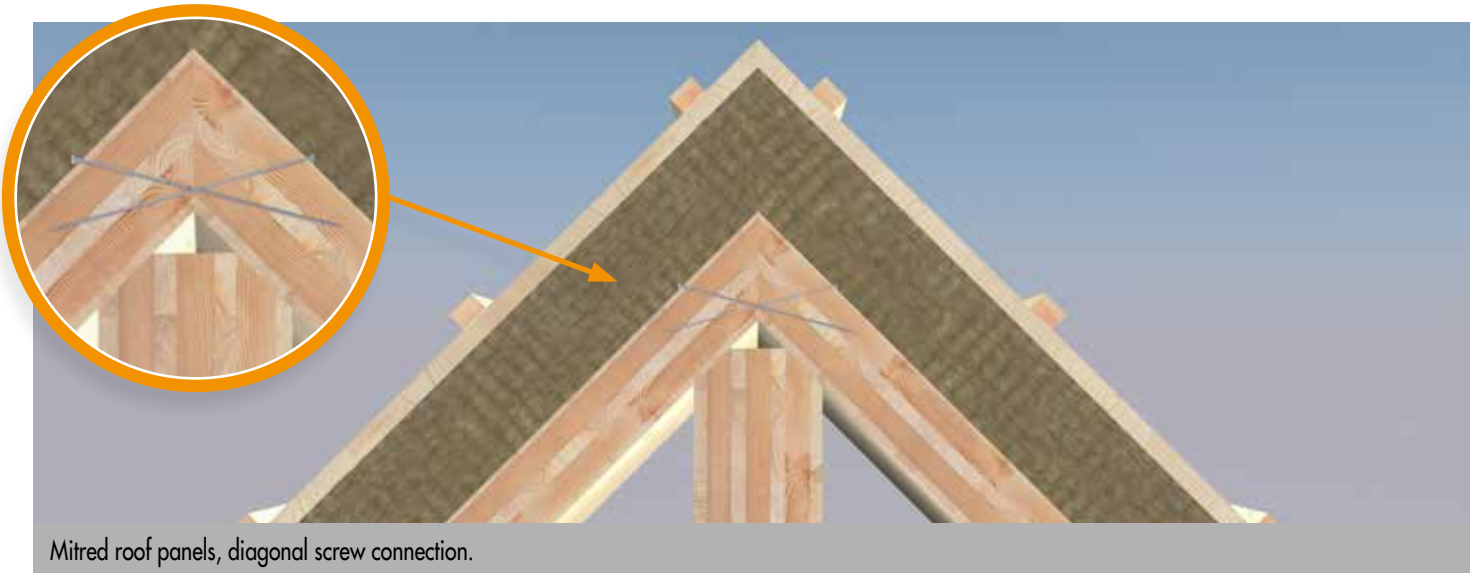
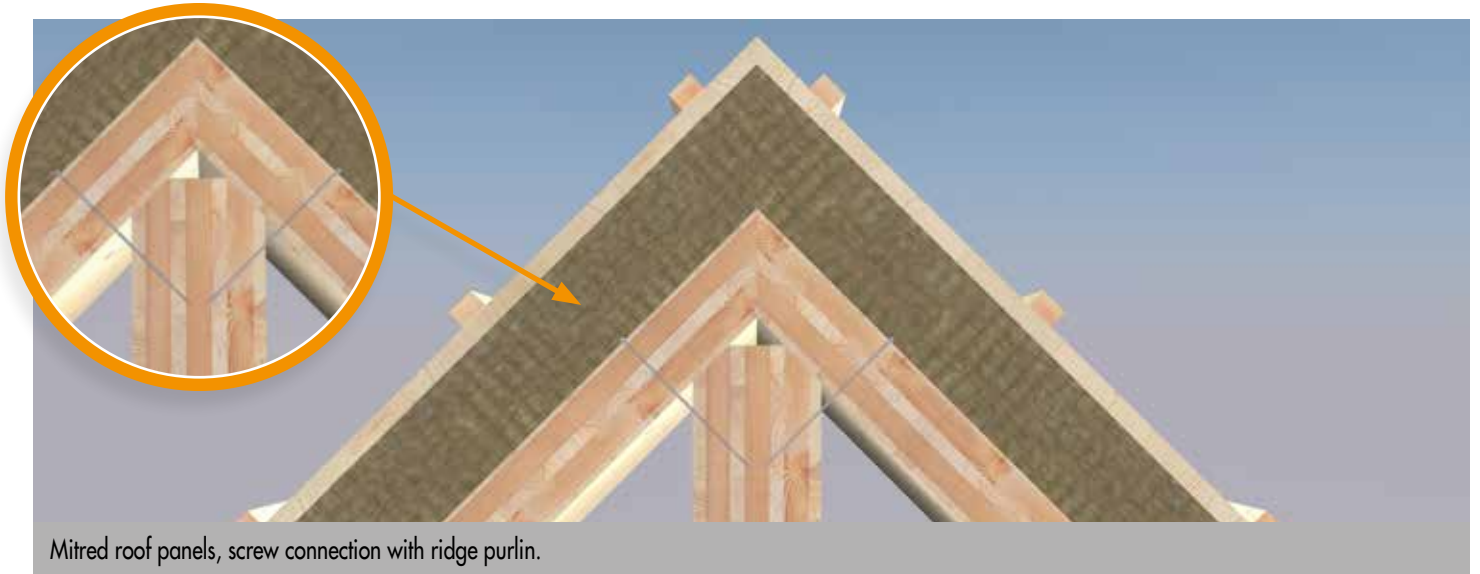

STAIRCASE CONSTRUCTION WITH CLT AND KONSTRUX

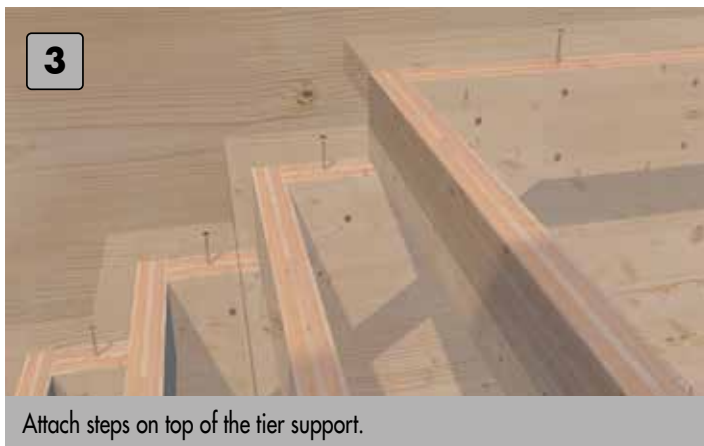
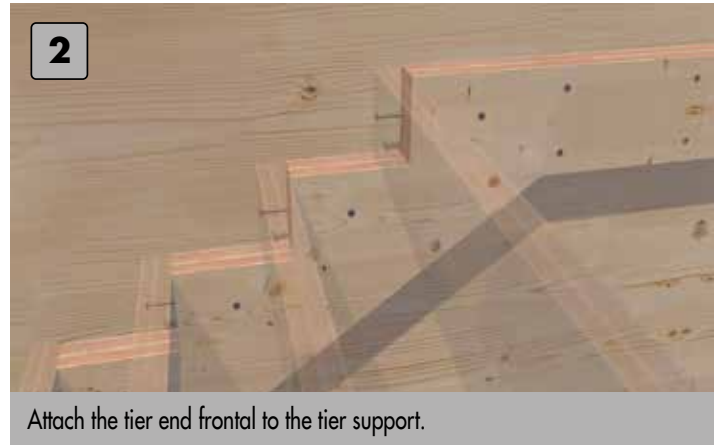



KonstruX ST fully threaded screw

Cylinder head, galvanised



BENEFITS OF DRILL POINT

- Reduced screwing torque
- High extraction resistance



Art. no.	Dimensions [mm]	Drive	PU
904808	6,5 x 80	TX30 ●	100
904809	6,5 x 100	TX30 ●	100
904810	6,5 x 120	TX30 ●	100
904811	6,5 x 140	TX30 ●	100
904812	6,5 x 160	TX30 ●	100
904813	6,5 x 195	TX30 ●	100
904825	8,0 x 155	TX40 ●	50
904826	8,0 x 195	TX40 ●	50
904827	8,0 x 220	TX40 ●	50
904828	8,0 x 245	TX40 ●	50
904834	8,0 x 270	TX40 ●	50
904829	8,0 x 295	TX40 ●	50
904830	8,0 x 330	TX40 ●	50
904831	8,0 x 375	TX40 ●	50
904832	8,0 x 400	TX40 ●	50
944804	8,0 x 430	TX40 ●	50
944805	8,0 x 480	TX40 ●	50
944806	8,0 x 530	TX40 ●	50
944807	8,0 x 580	TX40 ●	50
904815	10,0 x 300	TX50 ●	25
904816	10,0 x 330	TX50 ●	25
904817	10,0 x 360	TX50 ●	25
904818	10,0 x 400	TX50 ●	25
904819	10,0 x 450	TX50 ●	25
904820	10,0 x 500	TX50 ●	25
904821	10,0 x 550	TX50 ●	25
904822	10,0 x 600	TX50 ●	25

KonstruX ST threaded screw

Countersunk head, galvanised



BENEFITS OF DRILL POINT

- Reduced screwing torque
- High extraction resistance



Art. no.	Dimensions [mm]	Drive	PU
904857	6,5 x 80	TX30 ●	100
904858	6,5 x 100	TX30 ●	100
904859	6,5 x 120	TX30 ●	100
904860	6,5 x 140	TX30 ●	100
904790	8,0 x 95	TX40 ●	50
904791	8,0 x 125	TX40 ●	50
904792	8,0 x 155	TX40 ●	50
904793	8,0 x 195	TX40 ●	50
904794	8,0 x 220	TX40 ●	50
904795	8,0 x 245	TX40 ●	50
904796	8,0 x 270	TX40 ●	50
904797	8,0 x 295	TX40 ●	50
904798	8,0 x 330	TX40 ●	50
904799	8,0 x 375	TX40 ●	50
904800	8,0 x 400	TX40 ●	50
904801	8,0 x 430	TX40 ●	50
904802	8,0 x 480	TX40 ●	50
904803	8,0 x 545	TX40 ●	50
904770	10,0 x 125	TX50 ●	25
904771	10,0 x 155	TX50 ●	25
904772	10,0 x 195	TX50 ●	25
904773	10,0 x 220	TX50 ●	25
904774	10,0 x 245	TX50 ●	25
904775	10,0 x 270	TX50 ●	25
904776	10,0 x 300	TX50 ●	25
904777	10,0 x 330	TX50 ●	25
904778	10,0 x 360	TX50 ●	25
904779	10,0 x 400	TX50 ●	25
904780	10,0 x 450	TX50 ●	25
904781	10,0 x 500	TX50 ●	25
904782	10,0 x 550	TX50 ●	25
904783	10,0 x 600	TX50 ●	25

KonstruX threaded screw

Countersunk head, galvanised



ADVANTAGES SCREW TIP

- Faster and easier screwing
- Reduced splitting effect



Art. no.	Dimensions [mm]	Drive	PU
905737	11,3 x 300	TX50 •	20
905738	11,3 x 340	TX50 •	20
905739	11,3 x 380	TX50 •	20
905740	11,3 x 420	TX50 •	20
905741	11,3 x 460	TX50 •	20
905742	11,3 x 500	TX50 •	20
905743	11,3 x 540	TX50 •	20
905744	11,3 x 580	TX50 •	20
905745	11,3 x 620	TX50 •	20
905746	11,3 x 660	TX50 •	20
905747	11,3 x 700	TX50 •	20
905748	11,3 x 750	TX50 •	20
905749	11,3 x 800	TX50 •	20
904750	11,3 x 900	TX50 •	20
904751	11,3 x 1000	TX50 •	20

KonstruX threaded screw

Countersunk head, Stainless steel A4



Art. no.	Dimensions [mm]	Drive	PU
905750	10,0 x 160	TX50 •	25
905751	10,0 x 200	TX50 •	25
905752	10,0 x 220	TX50 •	25
905753	10,0 x 240	TX50 •	25
905754	10,0 x 260	TX50 •	25
905755	10,0 x 280	TX50 •	25
905756	10,0 x 300	TX50 •	25
905757	10,0 x 350	TX50 •	25
905758	10,0 x 400	TX50 •	25



ECS SOFTWARE FOR KONSTRUX

This user-friendly software allows pre-calculation of main/secondary beam connections, joist doubling and reinforcements of supports. Verifiable calculation aid in accordance with EN 1995 (Eurocode 5) and DIN 1052.

Download now www.eurotec.team/service

- **Ease of use**
- **Reliable planning**
- **Optimisation**

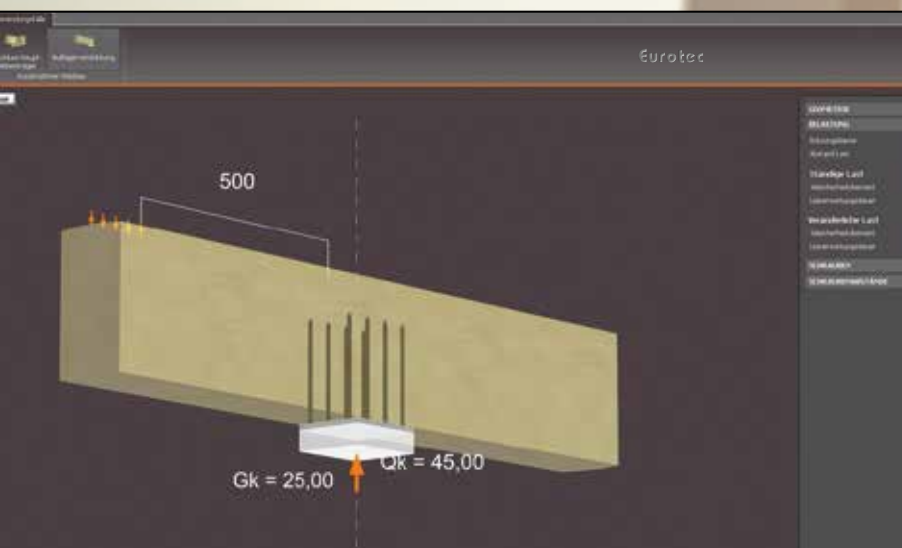
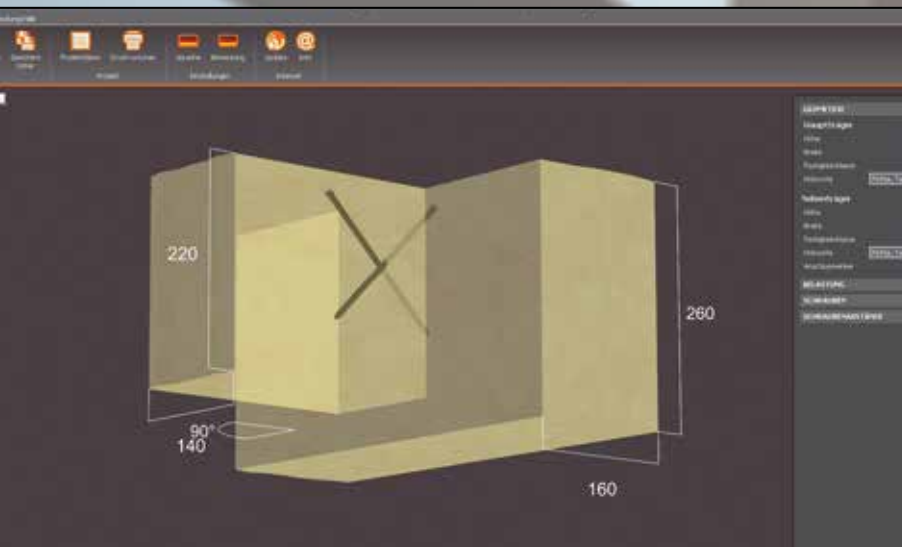

THE FAST AND SECURE TIMBER-JOINT SYSTEM

KONSTRUX CYLINDER-HEAD/COUNTERSUNK-HEAD SCREWS

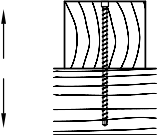
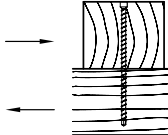
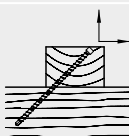
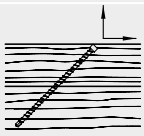
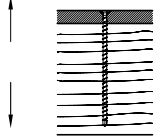
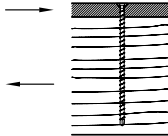
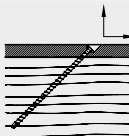
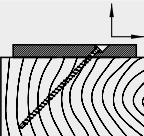
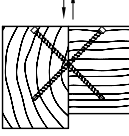
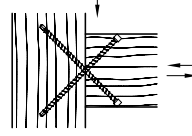
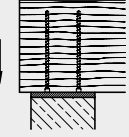
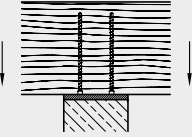
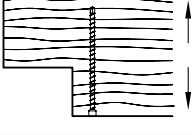
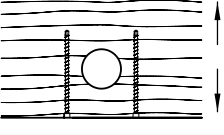
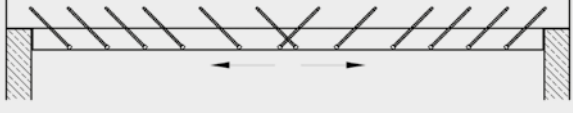
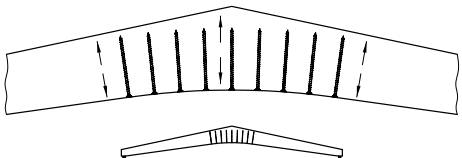
Application examples		Cylinder head			Countersunk head			
		Ø 6,5 [mm]	Ø 8,0 [mm]	Ø 10,0 [mm]	Ø 6,5 [mm]	Ø 8,0 [mm]	Ø 10,0 [mm]	Ø 11,3 [mm]
 <p>Timber-timber tensile loading</p>	 <p>Timber-timber shearing</p>	X	X	X	X	X	X	X
 <p>Timber-timber under tension at 45°</p>	 <p>Timber-timber under tension at 45°</p>	X	X	X	X	X	X	X
 <p>Steel-timber tensile loading</p>	 <p>Steel-timber shearing</p>	—	—	—	X	X	X	X
 <p>Steel-timber under tension at 45°</p>	 <p>Steel-timber under tension at 45°</p>	—	—	—	X	X	X	X
 <p>Main-secondary beam connection</p>	 <p>Post-crosspiece connection</p>	X	X	X	X	X	X	—
 <p>Support reinforcement</p>	 <p>Support reinforcement</p>	X	X	X	X	X	X	X
 <p>Transverse-shear reinforcement at notch</p>	 <p>Transverse-shear reinforcement at hole</p>	X	X	X	X	X	X	X
 <p>Joist doubling</p>		—	X	X	—	X	X	X
 <p>Transverse-shear reinforcement of building trusses</p>		—	—	X	—	—	X	X

KONSTRUX FULLY THREADED SCREW

TECHNICAL INFORMATION



KONSTRUX ST WITH CYLINDER HEAD AND DRILL POINT 6,5 TO 10,0 MM: TIMBER-TIMBER JOINTS

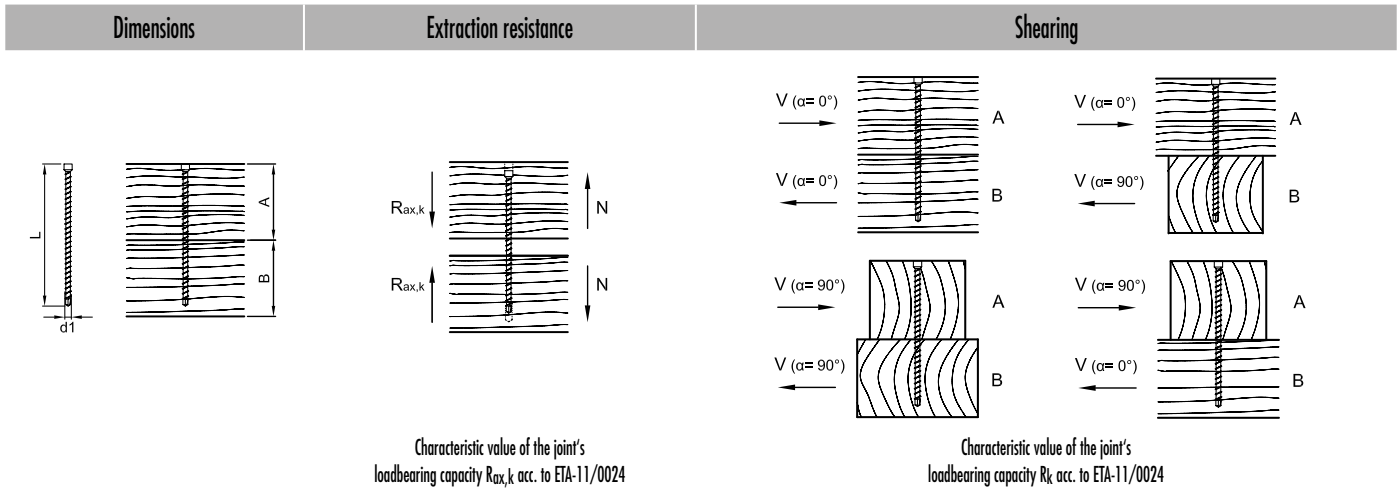

Characteristic value of the joint's loadbearing capacity $R_{ax,k}$ acc. to ETA-11/0024

Characteristic value of the joint's loadbearing capacity R_k acc. to ETA-11/0024

$d_1 \times L$ [mm]	A [mm]	B [mm]	$R_{ax,k}^{a)}$ - [kN]	$R_k^{a)}$ - [kN]			
				$\alpha = 0^\circ$	$\alpha = 90^\circ$	$\alpha_A = 0^\circ$	
						$\alpha_B = 90^\circ$	$\alpha_B = 0^\circ$
6,5 x 120	60	80	4,75	3,93	3,47	3,93	3,47
6,5 x 140	80	80	4,75	3,93	3,47	3,47	3,93
6,5 x 160	80	100	6,33	4,32	3,86	4,32	3,86
6,5 x 195	100	100	7,52	4,62	4,16	4,16	4,62
8,0 x 155	80	80	7,11	5,67	4,99	4,99	5,67
8,0 x 195	100	100	9,01	6,15	5,46	5,46	6,15
8,0 x 220	120	120	9,48	6,27	5,58	5,58	6,27
8,0 x 245	120	140	11,38	6,74	6,06	6,74	6,06
8,0 x 295	140	160	13,28	7,21	6,42	7,21	6,42
8,0 x 330	160	180	15,17	7,69	6,42	7,69	6,42
8,0 x 375	180	200	17,07	7,79	6,42	7,79	6,42
8,0 x 400	200	220	18,97	7,79	6,42	7,79	6,42
8,0 x 430	220	220	19,92	7,79	6,42	6,42	7,79
8,0 x 480	240	260	22,76	7,79	6,42	7,79	6,42
10,0 x 300	160	160	16,15	9,48	8,48	8,48	9,48
10,0 x 330	160	180	18,46	10,06	8,90	10,06	8,90
10,0 x 360	180	200	20,76	10,64	8,90	10,64	8,90
10,0 x 400	200	220	23,07	10,89	8,90	10,89	8,90
10,0 x 450	220	240	25,38	10,89	8,90	10,89	8,90
10,0 x 500	240	280	27,68	10,89	8,90	10,89	8,90
10,0 x 550	260	300	29,99	10,89	8,90	10,89	8,90
10,0 x 600	300	320	33,00	10,89	8,90	10,89	8,90

Calculation according to ETA-11/0024. Wood density $\rho_k = 380 \text{ kg/m}^3$. All mechanical values provided should be viewed as subject to the assumptions that have been made and represent example calculations.

All values are calculated minimum values and are subject to typographical and printing errors.

a) The characteristic values of the load-bearing capacity R_k cannot be treated as equivalent to the max. possible load (the max. force). Characteristic values of the load-bearing capacity R_k should be reduced to dimensioning values R_d with regard to the usage class and class of the load duration: $R_d = R_k \cdot k_{mod} / \gamma_M$. The dimensioning values of the load-bearing capacity R_d should be contrasted with the dimensioning values of the loads ($R_d \geq E_d$).

Example:

Characteristic value for constant load (dead weight) $G_k = 2,00 \text{ kN}$ and variable load (e. g. snow load) $Q_k = 3,00 \text{ kN}$. $k_{mod} = 0,9$. $\gamma_M = 1,3$.

→ Dimensioning value of the load $E_d = 2,00 \cdot 1,35 + 3,00 \cdot 1,5 = 7,20 \text{ kN}$.

The load-bearing capacity of the joint is therefore considered to have been demonstrated if $R_d \geq E_d$. → $\min R_k = R_d \cdot \gamma_M / k_{mod}$

i.e. the characteristic minimum value is calculated based on: $\min R_k = R_d \cdot \gamma_M / k_{mod} \rightarrow R_k = 7,20 \text{ kN} \cdot 1,3 / 0,9 = 10,40 \text{ kN}$ → comparison with table values.

Please note: These are planning aids. Projects must only be calculated by authorised persons.

KONSTRUX ST WITH CYLINDER HEAD AND DRILL POINT 6,5 TO 10,0 MM: TIMBER-TIMBER JOINTS

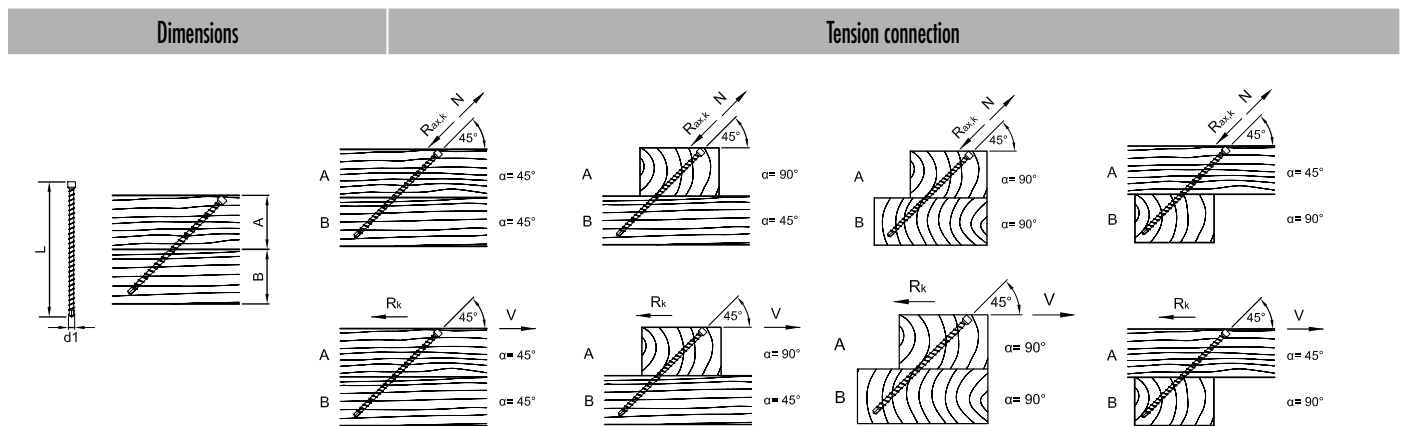

Characteristic value of the joint's load-bearing capacity $R_{\alpha x, k}$ or R_k acc. to ETA-11/0024

d1 x L [mm]	A [mm]	B [mm]	$\alpha = 45^\circ$		$\alpha_A = 90^\circ$ $\alpha_B = 45^\circ$		$\alpha_A = 90^\circ$ $\alpha_B = 90^\circ$		$\alpha_A = 45^\circ$ $\alpha_B = 90^\circ$	
			$R_{\alpha x, k}^a)$ - [kN]	$R_k^a)$ - [kN]	$R_{\alpha x, k}^a)$ - [kN]	$R_k^a)$ - [kN]	$R_{\alpha x, k}^a)$ - [kN]	$R_k^a)$ - [kN]	$R_{\alpha x, k}^a)$ - [kN]	$R_k^a)$ - [kN]
6,5 x 160	60	80	5,95	4,21	5,95	4,21	5,95	4,21	5,95	4,21
6,5 x 195	80	80	6,48	4,58	6,48	4,58	6,48	4,58	6,48	4,58
8,0 x 155	60	60	6,65	4,70	6,65	4,70	6,65	4,70	6,65	4,70
8,0 x 195	80	80	7,76	5,49	7,76	5,49	7,76	5,49	7,76	5,49
8,0 x 220	80	100	10,13	7,17	10,13	7,17	10,13	7,17	10,13	7,17
8,0 x 245	100	100	9,82	6,95	9,82	6,95	9,82	6,95	9,82	6,95
8,0 x 295	120	100	11,88	8,40	11,88	8,40	11,88	8,40	11,88	8,40
8,0 x 330	120	140	15,20	10,75	15,20	10,75	15,20	10,75	15,20	10,75
8,0 x 375	140	140	16,79	11,87	16,79	11,87	16,79	11,87	16,79	11,87
8,0 x 400	160	140	16,48	11,65	16,48	11,65	16,48	11,65	16,48	11,65
8,0 x 430	160	160	19,32	13,66	19,32	13,66	19,32	13,66	19,32	13,66
8,0 x 480	180	180	21,38	15,12	21,38	15,12	21,38	15,12	21,38	15,12
10,0 x 300	120	120	15,03	10,63	15,03	10,63	15,03	10,63	15,03	10,63
10,0 x 330	120	140	18,49	13,07	18,49	13,07	18,49	13,07	18,49	13,07
10,0 x 360	140	140	18,69	13,21	18,69	13,21	18,69	13,21	18,69	13,21
10,0 x 400	160	140	20,04	14,17	20,04	14,17	20,04	14,17	20,04	14,17
10,0 x 450	160	180	25,81	18,25	25,81	18,25	25,81	18,25	25,81	18,25
10,0 x 500	180	200	28,31	20,02	28,31	20,02	28,31	20,02	28,31	20,02
10,0 x 550	200	200	30,82	21,79	30,82	21,79	30,82	21,79	30,82	21,79
10,0 x 600	220	220	33,00	23,33	33,00	23,33	33,00	23,33	33,00	23,33

Calculation according to ETA-11/0024. Wood density $\rho_k = 380 \text{ kg/m}^3$. All mechanical values provided should be viewed as subject to the assumptions that have been made and represent example calculations.

All values are calculated minimum values and are subject to typographical and printing errors.

a) The characteristic values of the load-bearing capacity R_k cannot be treated as equivalent to the max. possible load (the max. force). Characteristic values of the load-bearing capacity R_k should be reduced to dimensioning values R_d with regard to the usage class and class of the load duration: $R_d = R_k \cdot k_{mod} / \gamma_M$. The dimensioning values of the load-bearing capacity R_d should be contrasted with the dimensioning values of the loads ($R_d \geq E_d$).

Example:

Characteristic value for constant load (dead weight) $G_k = 2,00 \text{ kN}$ and variable load (e. g. snow load) $Q_k = 3,00 \text{ kN}$. $k_{mod} = 0,9$. $\gamma_M = 1,3$.

→ Dimensioning value of the load $E_d = 2,00 \cdot 1,35 + 3,00 \cdot 1,5 = 7,20 \text{ kN}$.

The load-bearing capacity of the joint is therefore considered to have been demonstrated if $R_d \geq E_d$. → $\min R_k = R_d \cdot \gamma_M / k_{mod}$

i.e. the characteristic minimum value is calculated based on: $\min R_k = R_d \cdot \gamma_M / k_{mod} \rightarrow R_k = 7,20 \text{ kN} \cdot 1,3 / 0,9 = 10,40 \text{ kN}$ → comparison with table values.

Please note: These are planning aids. Projects must only be calculated by authorised persons.

Please note: Verify the assumptions made. The stated values, and type and number of joining devices are based on preliminary measurements. Projects are to be dimensioned exclusively by authorised persons in accordance with the State Building Code. As per LBauO, please contact a qualified structural engineer for a paid proof of stability. We will be happy to refer you to someone.

KONSTRUX ST WITH COUNTERSUNK HEAD AND DRILL POINT 6,5 TO 10,0 MM: TIMBER-TIMBER JOINTS

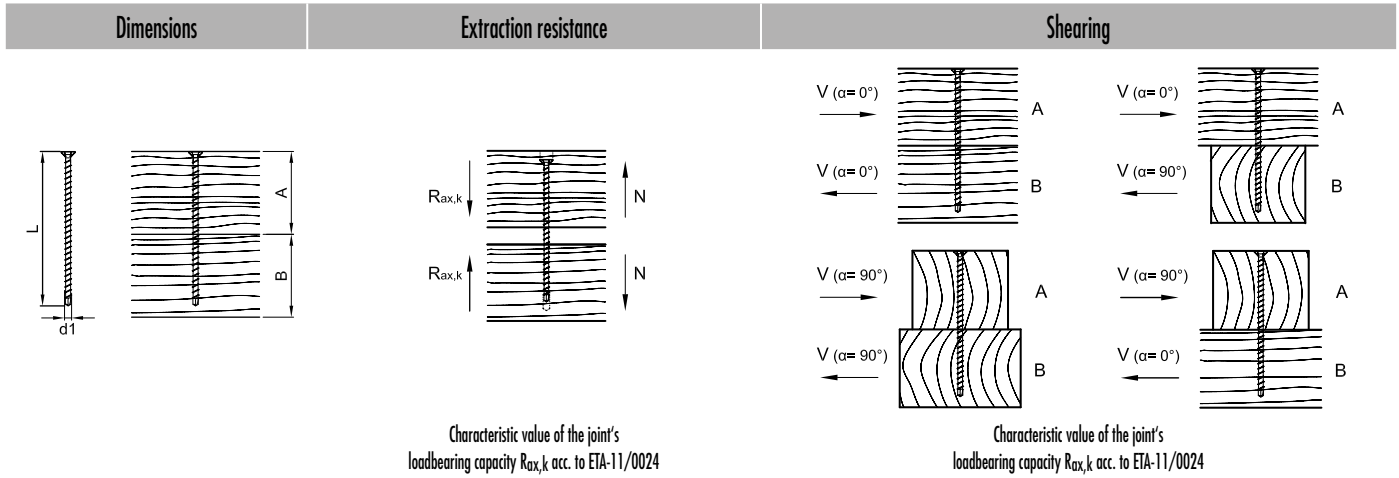

Characteristic value of the joint's
loadbearing capacity $R_{ax,k}$ acc. to ETA-11/0024

Characteristic value of the joint's
loadbearing capacity $R_{ax,k}$ acc. to ETA-11/0024

$d_1 \times L$ [mm]	A [mm]	B [mm]	$R_{ax,k}^{a)}$ - [kN]	$R_k^{a)}$ - [kN]		$R_k^{a)}$ - [kN]	
				$\alpha = 0^\circ$	$\alpha = 90^\circ$	$\alpha_A = 0^\circ$ $\alpha_B = 90^\circ$	$\alpha_A = 90^\circ$ $\alpha_B = 0^\circ$
6,5 x 120	60	80	4,75	3,93	3,47	3,93	3,47
6,5 x 140	80	80	4,75	3,93	3,47	3,47	3,93
8,0 x 95	40	60	3,08	4,61	3,57	4,61	3,57
8,0 x 125	60	80	4,61	5,05	4,37	5,05	4,37
8,0 x 155	80	80	7,11	5,67	4,99	4,99	5,67
8,0 x 195	100	100	9,01	6,15	5,46	5,46	6,15
8,0 x 220	120	120	9,48	6,27	5,58	5,58	6,27
8,0 x 245	120	140	11,38	6,74	6,06	6,74	6,06
8,0 x 270	140	140	12,33	6,98	6,29	6,29	6,98
8,0 x 295	140	160	13,28	7,21	6,42	7,21	6,42
8,0 x 330	160	180	15,17	7,69	6,42	7,69	6,42
8,0 x 375	180	200	17,07	7,79	6,42	7,79	6,42
8,0 x 400	200	220	18,97	7,79	6,42	7,79	6,42
8,0 x 430	220	220	19,92	7,79	6,42	6,42	7,79
8,0 x 480	240	260	22,76	7,79	6,42	7,79	6,42
10,0 x 125	60	80	6,92	7,18	6,18	7,18	6,18
10,0 x 155	80	80	8,65	7,61	6,61	6,61	7,61
10,0 x 195	100	100	10,96	8,19	7,19	7,19	8,19
10,0 x 220	120	120	11,53	8,33	7,33	7,33	8,33
10,0 x 245	120	140	13,84	8,91	7,91	8,91	7,91
10,0 x 270	140	140	14,99	9,20	8,20	8,20	9,20
10,0 x 300	160	160	16,15	9,48	8,48	8,48	9,48
10,0 x 330	160	180	18,46	10,06	8,90	10,06	8,90
10,0 x 360	180	200	20,76	10,64	8,90	10,64	8,90
10,0 x 400	200	220	23,07	10,89	8,90	10,89	8,90
10,0 x 450	220	240	25,38	10,89	8,90	10,89	8,90
10,0 x 500	240	280	27,68	10,89	8,90	10,89	8,90
10,0 x 550	260	300	29,99	10,89	8,90	10,89	8,90
10,0 x 600	300	320	33,00	10,89	8,90	10,89	8,90

Calculation according to ETA-11/0024. Wood density $\rho_k = 380 \text{ kg/m}^3$. All mechanical values provided should be viewed as subject to the assumptions that have been made and represent example calculations.

All values are calculated minimum values and are subject to typographical and printing errors.

a) The characteristic values of the load-bearing capacity R_k cannot be treated as equivalent to the max. possible load (the max. force). Characteristic values of the load-bearing capacity R_k should be reduced to dimensioning values R_d with regard to the usage class and class of the load duration: $R_d = R_k \cdot k_{mod} / \gamma_M$. The dimensioning values of the load-bearing capacity R_d should be contrasted with the dimensioning values of the loads ($R_d \geq E_d$).

Example:

Characteristic value for constant load (dead weight) $G_k = 2,00 \text{ kN}$ and variable load (e. g. snow load) $Q_k = 3,00 \text{ kN}$. $k_{mod} = 0,9$. $\gamma_M = 1,3$. \rightarrow Dimensioning value of the load $E_d = 2,00 \cdot 1,35 + 3,00 \cdot 1,5 = 7,20 \text{ kN}$. The load-bearing capacity of the joint is therefore considered to have been demonstrated if $R_d \geq E_d$. $\rightarrow \min R_k = R_d \cdot \gamma_M / k_{mod}$. i.e. the characteristic minimum value is calculated based on: $\min R_k = R_d \cdot \gamma_M / k_{mod} \rightarrow R_k = 7,20 \text{ kN} \cdot 1,3 / 0,9 = 10,40 \text{ kN} \rightarrow$ comparison with table values.

Please note: These are planning aids. Projects must only be calculated by authorised persons.

KONSTRUX ST WITH COUNTERSUNK HEAD AND DRILL POINT

8,0 AND 10,0 MM: TIMBER-TIMBER JOINTS

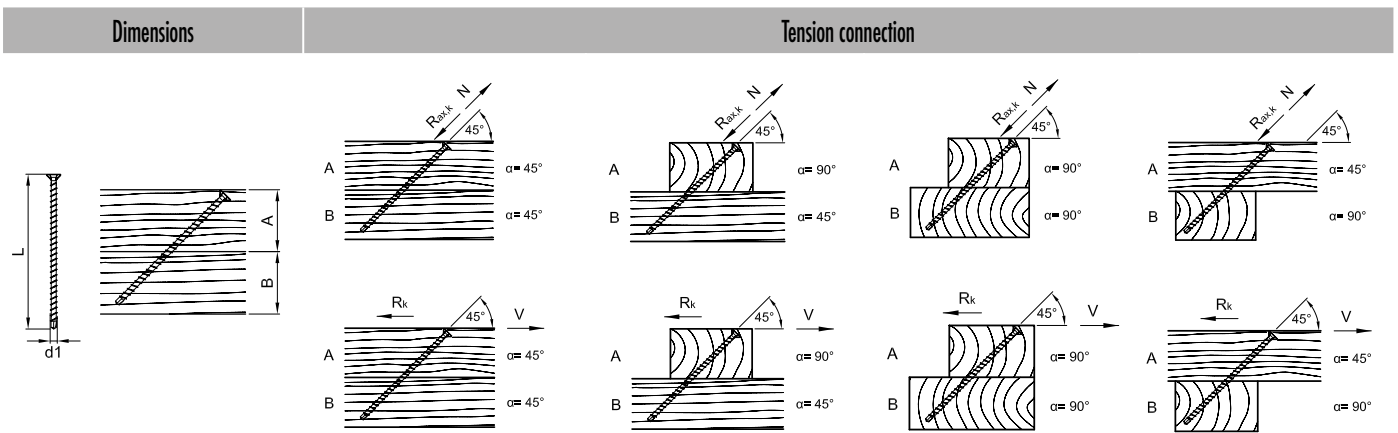

Characteristic value of the joint's loadbearing capacity $R_{ax,k}$ bzw. R_k acc. to ETA-11/0024

d1 x L [mm]	A [mm]	B [mm]	$\alpha = 45^\circ$		$\alpha_A = 90^\circ$ $\alpha_B = 45^\circ$		$\alpha_A = 90^\circ$ $\alpha_B = 90^\circ$		$\alpha_A = 45^\circ$ $\alpha_B = 90^\circ$	
			$R_{ax,k}^{a)}$ - [kN]	$R_k^{a)}$ - [kN]	$R_{ax,k}^{a)}$ - [kN]	$R_k^{a)}$ - [kN]	$R_{ax,k}^{a)}$ - [kN]	$R_k^{a)}$ - [kN]	$R_{ax,k}^{a)}$ - [kN]	$R_k^{a)}$ - [kN]
8,0 x 155	60	60	6,65	4,70	6,65	4,70	6,65	4,70	6,65	4,70
8,0 x 195	80	80	7,76	5,49	7,76	5,49	7,76	5,49	7,76	5,49
8,0 x 220	80	100	10,13	7,17	10,13	7,17	10,13	7,17	10,13	7,17
8,0 x 245	100	100	9,82	6,95	9,82	6,95	9,82	6,95	9,82	6,95
8,0 x 270	100	120	12,19	8,62	12,19	8,62	12,19	8,62	12,19	8,62
8,0 x 295	120	100	11,88	8,40	11,88	8,40	11,88	8,40	11,88	8,40
8,0 x 330	120	140	15,20	10,75	15,20	10,75	15,20	10,75	15,20	10,75
8,0 x 375	140	140	16,79	11,87	16,79	11,87	16,79	11,87	16,79	11,87
8,0 x 400	160	140	16,48	11,65	16,48	11,65	16,48	11,65	16,48	11,65
8,0 x 430	160	160	19,32	13,66	19,32	13,66	19,32	13,66	19,32	13,66
8,0 x 480	180	180	21,38	15,12	21,38	15,12	21,38	15,12	21,38	15,12
10,0 x 220	80	100	12,33	8,72	12,33	8,72	12,33	8,72	12,33	8,72
10,0 x 245	100	100	11,95	8,45	11,95	8,45	11,95	8,45	11,95	8,45
10,0 x 270	100	120	14,83	10,49	14,83	10,49	14,83	10,49	14,83	10,49
10,0 x 300	120	120	15,03	10,63	15,03	10,63	15,03	10,63	15,03	10,63
10,0 x 330	120	140	18,49	13,07	18,49	13,07	18,49	13,07	18,49	13,07
10,0 x 360	140	140	18,69	13,21	18,69	13,21	18,69	13,21	18,69	13,21
10,0 x 400	160	140	20,04	14,17	20,04	14,17	20,04	14,17	20,04	14,17
10,0 x 450	160	180	25,81	18,25	25,81	18,25	25,81	18,25	25,81	18,25
10,0 x 500	180	200	28,31	20,02	28,31	20,02	28,31	20,02	28,31	20,02
10,0 x 550	200	200	30,82	21,79	30,82	21,79	30,82	21,79	30,82	21,79
10,0 x 600	220	220	33,00	23,33	33,00	23,33	33,00	23,33	33,00	23,33

Calculation according to ETA-11/0024. Wood density $\rho_k = 380 \text{ kg/m}^3$. All mechanical values provided should be viewed as subject to the assumptions that have been made and represent example calculations.

All values are calculated minimum values and are subject to typographical and printing errors.

a) The characteristic values of the load-bearing capacity R_k cannot be treated as equivalent to the max. possible load (the max. force). Characteristic values of the load-bearing capacity R_k should be reduced to dimensioning values R_d with regard to the usage class and class of the load duration: $R_d = R_k \cdot k_{mod} / \gamma_M$. The dimensioning values of the load-bearing capacity R_d should be contrasted with the dimensioning values of the loads ($R_d \geq E_d$).

Example:

Characteristic value for constant load (dead weight) $G_k = 2,00 \text{ kN}$ and variable load (e. g. snow load) $Q_k = 3,00 \text{ kN}$. $k_{mod} = 0,9$. $\gamma_M = 1,3$.

→ Dimensioning value of the load $E_d = 2,00 \cdot 1,35 + 3,00 \cdot 1,5 = 7,20 \text{ kN}$.

The load-bearing capacity of the joint is therefore considered to have been demonstrated if $R_d \geq E_d$. → $\min R_k = R_d \cdot \gamma_M / k_{mod}$

i.e. the characteristic minimum value is calculated based on: $\min R_k = R_d \cdot \gamma_M / k_{mod} \rightarrow R_k = 7,20 \text{ kN} \cdot 1,3 / 0,9 = 10,40 \text{ kN}$ → comparison with table values.

Please note: These are planning aids. Projects must only be calculated by authorised persons.

KONSTRUX WITH COUNTERSUNK HEAD AND DRILL POINT OR AG TIP 11,3 MM: TIMBER-TIMBER CONNECTION

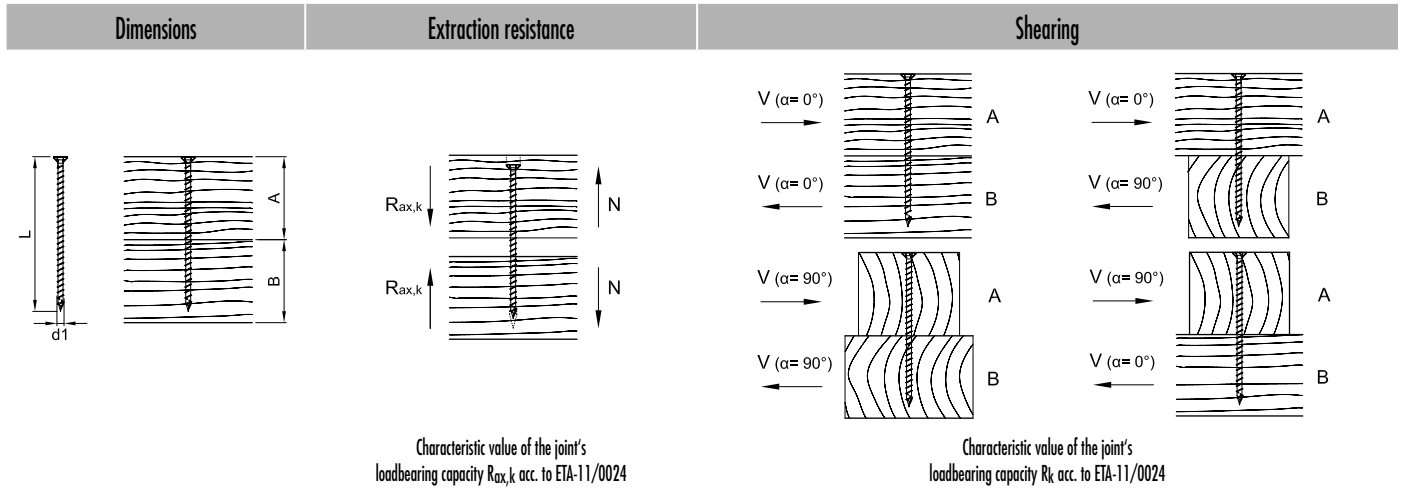

d1 x L [mm]	A [mm]	B [mm]	$R_{ax,k}^{a)}$ - [kN]	$R_k^{a)}$ - [kN]		$R_k^{a)}$ - [kN]	
				$\alpha=0^\circ$	$\alpha=90^\circ$	$\alpha_A=0^\circ$	$\alpha_A=90^\circ$
						$\alpha_B=90^\circ$	$\alpha_B=0^\circ$
11,3 x 300	160	160	18,25	12,17	10,73	10,73	12,17
11,3 x 340	180	180	20,85	12,82	11,38	11,38	12,82
11,3 x 380	200	200	23,46	13,47	12,03	12,03	13,47
11,3 x 420	220	220	26,07	14,12	12,34	12,34	14,12
11,3 x 460	240	240	26,67	14,77	12,34	12,34	14,77
11,3 x 500	260	260	31,28	15,21	12,34	12,34	15,21
11,3 x 540	280	280	33,89	15,21	12,34	12,34	15,21
11,3 x 580	300	300	36,49	15,21	12,34	12,34	15,21
11,3 x 620	320	320	39,10	15,21	12,34	12,34	15,21
11,3 x 660	340	340	41,71	15,21	12,34	12,34	15,21
11,3 x 700	360	360	44,32	15,21	12,34	12,34	15,21
11,3 x 750	380	380	48,23	15,21	12,34	12,34	15,21
11,3 x 800	400	420	50,00	15,21	12,34	15,21	12,34
11,3 x 900	460	460	50,00	15,21	12,34	12,34	15,21
11,3 x 1000	500	520	50,00	15,21	12,34	15,21	12,34

Calculation according to ETA-11/0024. Wood density $\rho_k=380 \text{ kg/m}^3$. All mechanical values provided should be viewed as subject to the assumptions that have been made and represent example calculations.

All values are calculated minimum values and are subject to typographical and printing errors.

a) The characteristic values of the load-bearing capacity R_k cannot be treated as equivalent to the max. possible load (the max. force). Characteristic values of the load-bearing capacity R_k should be reduced to dimensioning values R_d with regard to the usage class and class of the load duration: $R_d=R_k \cdot k_{mod} / \gamma_M$. The dimensioning values of the load-bearing capacity R_d should be contrasted with the dimensioning values of the loads ($R_d \geq E_d$).

Example:

Characteristic value for constant load (dead weight) $G_k=2,00 \text{ kN}$ and variable load (e. g. snow load) $Q_k=3,00 \text{ kN}$. $k_{mod}=0,9$. $\gamma_M=1,3$.

→ Dimensioning value of the load $E_d=2,00 \cdot 1,35 + 3,00 \cdot 1,5=7,20 \text{ kN}$.

The load-bearing capacity of the joint is therefore considered to have been demonstrated if $R_d \geq E_d$. → $\min R_k=R_d \cdot \gamma_M / k_{mod}$

i.e. the characteristic minimum value is calculated based on: $\min R_k=R_d \cdot \gamma_M / k_{mod} \rightarrow R_k=7,20 \text{ kN} \cdot 1,3/0,9=10,40 \text{ kN}$ → comparison with table values.

Please note: These are planning aids. Projects must only be calculated by authorised persons.

KONSTRUX WITH COUNTERSUNK HEAD AND DRILL POINT OR AG TIP 11,3 MM: TIMBER-TIMBER CONNECTION

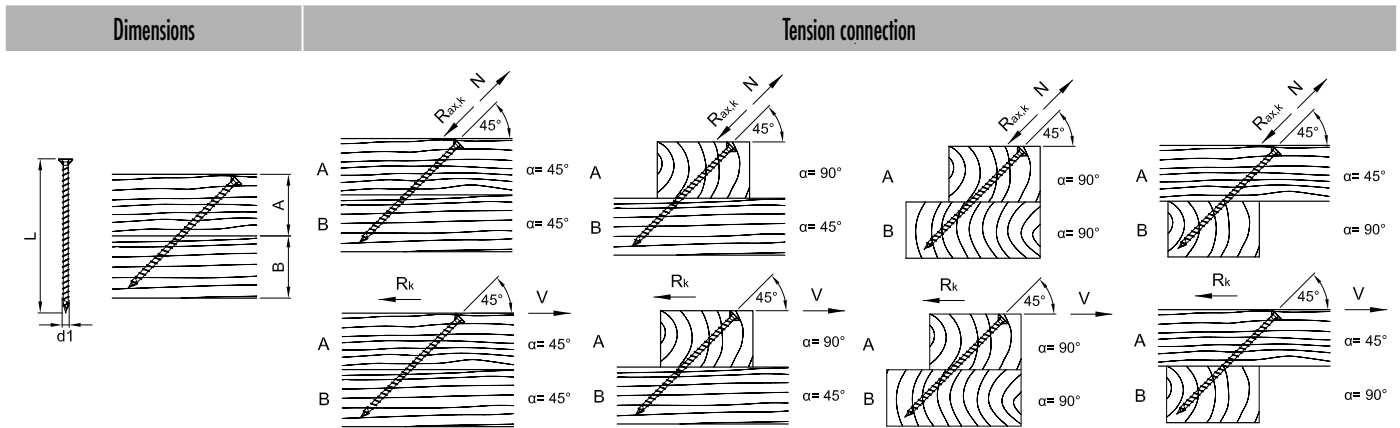

Characteristic value of the joint's load-bearing capacity $R_{ax,k}$ or R_k acc. to ETA-11/0024

d1 x L [mm]	A [mm]	B [mm]	$R_{ax,k}^{a)}$ - [kN]	$R_k^{a)}$ - [kN]	$R_{ax,k}^{a)}$ - [kN]	$R_k^{a)}$ - [kN]	$R_{ax,k}^{a)}$ - [kN]	$R_k^{a)}$ - [kN]	$R_{ax,k}^{a)}$ - [kN]	$R_k^{a)}$ - [kN]
			$\alpha = 45^\circ$		$\alpha_A = 90^\circ$ $\alpha_B = 45^\circ$		$\alpha_A = 90^\circ$ $\alpha_B = 90^\circ$		$\alpha_A = 45^\circ$ $\alpha_B = 90^\circ$	
11,3 x 300	120	120	16,98	12,01	16,98	12,01	16,98	12,01	16,98	12,01
11,3 x 340	140	120	18,51	13,09	18,51	13,09	18,51	13,09	18,51	13,09
11,3 x 380	140	140	23,72	16,77	23,72	16,77	23,72	16,77	23,72	16,77
11,3 x 420	160	160	25,25	17,85	25,25	17,85	25,25	17,85	25,25	17,85
11,3 x 460	180	160	26,78	18,93	26,78	18,93	26,78	18,93	26,78	18,93
11,3 x 500	180	200	31,99	22,62	31,99	22,62	31,99	22,62	31,99	22,62
11,3 x 540	200	200	33,52	23,70	33,52	23,70	33,52	23,70	33,52	23,70
11,3 x 580	220	220	35,04	24,78	35,04	24,78	35,04	24,78	35,04	24,78
11,3 x 620	220	240	40,26	28,47	40,26	28,47	40,26	28,47	40,26	28,47
11,3 x 660	240	240	41,79	29,55	41,79	29,55	41,79	29,55	41,79	29,55
11,3 x 700	260	260	43,31	30,63	43,31	30,63	43,31	30,63	43,31	30,63
11,3 x 750	280	280	46,14	32,63	46,14	32,63	46,14	32,63	46,14	32,63
11,3 x 800	300	280	48,97	34,63	48,97	34,63	48,97	34,63	48,97	34,63
11,3 x 900	320	340	50,00	35,36	50,00	35,36	50,00	35,36	50,00	35,36
11,3 x 1000	360	360	50,00	35,36	50,00	35,36	50,00	35,36	50,00	35,36

Calculation according to ETA-11/0024. Wood density $\rho_k = 380 \text{ kg/m}^3$. All mechanical values provided should be viewed as subject to the assumptions that have been made and represent example calculations.

All values are calculated minimum values and are subject to typographical and printing errors.

a) The characteristic values of the load-bearing capacity R_k cannot be treated as equivalent to the max. possible load (the max. force). Characteristic values of the load-bearing capacity R_k should be reduced to dimensioning values R_d with regard to the usage class and class of the load duration: $R_d = R_k \cdot k_{mod} / \gamma_M$. The dimensioning values of the load-bearing capacity R_d should be contrasted with the dimensioning values of the loads ($R_d \geq E_d$).

Example:

Characteristic value for constant load (dead weight) $G_k = 2,00 \text{ kN}$ and variable load (e. g. snow load) $Q_k = 3,00 \text{ kN}$. $k_{mod} = 0,9$. $\gamma_M = 1,3$.

→ Dimensioning value of the load $E_d = 2,00 \cdot 1,35 + 3,00 \cdot 1,5 = 7,20 \text{ kN}$.

The load-bearing capacity of the joint is therefore considered to have been demonstrated if $R_d \geq E_d$. → $\min R_k = R_d \cdot \gamma_M / k_{mod}$

i.e. the characteristic minimum value is calculated based on: $\min R_k = R_d \cdot \gamma_M / k_{mod} \rightarrow R_k = 7,20 \text{ kN} \cdot 1,3/0,9 = 10,40 \text{ kN}$ → comparison with table values.

Please note: These are planning aids. Projects must only be calculated by authorised persons.

KONSTRUX ST WITH COUNTERSUNK HEAD AND DRILL POINT 6,5 TO 10,0 MM: STEEL-TIMBER JOINTS

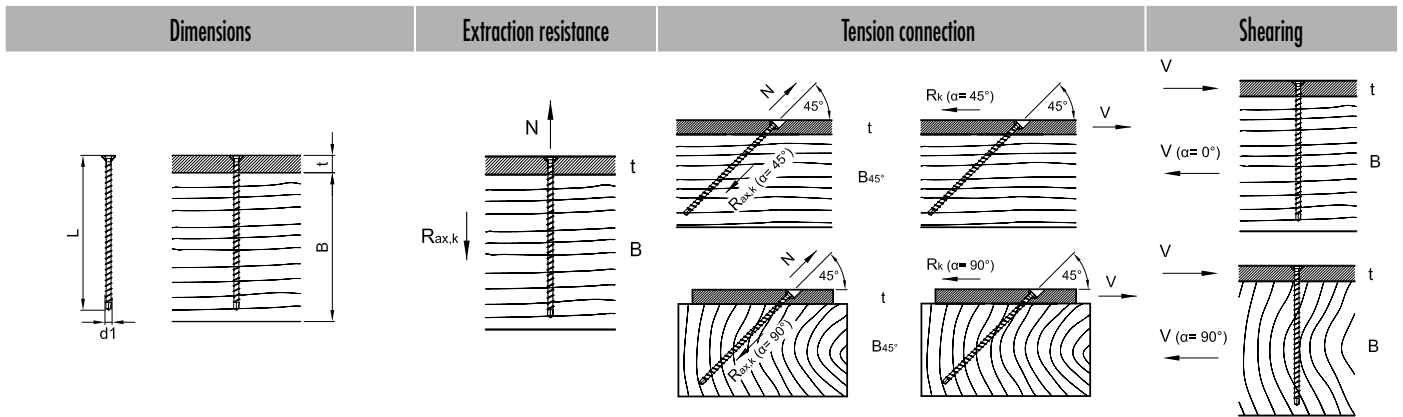

Characteristic value of the joint's loadbearing capacity $R_{ax,k}$ acc. to ETA-11/0024

Characteristic value of the joint's loadbearing capacity $R_{ax,k}$ bzw. R_k acc. to ETA-11/0024

Characteristic value of the joint's loadbearing capacity R_k acc. to ETA-11/0024

$d1 \times L$ [mm]	t [mm]	B [mm]	B_{45° [mm]	$R_{ax,k}^{a)}$ - [kN]	$R_{ax,k}^{a)}$ - [kN]		$R_k^{a)}$ - [kN]		$R_k^{a)}$ - [kN]	
					$\alpha=45^\circ$	$\alpha=90^\circ$	$\alpha=45^\circ$	$\alpha=90^\circ$	$\alpha=0^\circ$	$\alpha=90^\circ$
6,5 x 80	15	80	60	5,14	4,65	4,65	3,29	3,29	4,17	3,52
6,5 x 100	15	100	80	6,73	6,24	6,24	4,41	4,41	4,17	3,52
6,5 x 120	15	120	80	8,31	7,82	7,82	5,53	5,53	4,17	3,52
6,5 x 140	15	140	100	9,89	9,40	9,40	6,65	6,65	4,17	3,52
8,0 x 95	15	100	80	7,59	7,00	7,00	4,95	4,95	6,18	5,22
8,0 x 125	15	120	100	10,43	9,84	9,84	6,96	6,96	6,18	5,22
8,0 x 155	15	160	120	13,28	12,69	12,69	8,97	8,97	6,18	5,22
8,0 x 195	15	200	140	17,07	16,48	16,48	11,65	11,65	6,18	5,22
8,0 x 220	15	220	160	19,44	18,85	18,85	13,33	13,33	6,18	5,22
8,0 x 245	15	240	180	21,81	21,22	21,22	15,01	15,01	6,18	5,22
8,0 x 270	15	280	200	24,18	23,59	23,59	16,68	16,68	6,18	5,22
8,0 x 295	15	300	220	25,00	25,00	25,00	17,68	17,68	6,18	5,22
8,0 x 330	15	340	240	25,00	25,00	25,00	17,68	17,68	6,18	5,22
8,0 x 375	15	380	280	25,00	25,00	25,00	17,68	17,68	6,18	5,22
8,0 x 400	15	400	280	25,00	25,00	25,00	17,68	17,68	6,18	5,22
8,0 x 430	15	440	300	25,00	25,00	25,00	17,68	17,68	6,18	5,22
8,0 x 480	15	480	340	25,00	25,00	25,00	17,68	17,68	6,18	5,22
10,0 x 125	15	120	100	12,69	11,97	11,97	8,46	8,46	8,72	7,30
10,0 x 155	15	160	120	16,15	15,43	15,43	10,91	10,91	8,72	7,30
10,0 x 195	15	200	140	20,76	20,05	20,05	14,17	14,17	8,72	7,30
10,0 x 220	15	220	160	23,65	22,93	22,93	16,21	16,21	8,72	7,30
10,0 x 245	15	240	180	26,53	25,81	25,81	18,25	18,25	8,72	7,30
10,0 x 270	15	280	200	29,41	28,70	28,70	20,29	20,29	8,72	7,30
10,0 x 300	15	300	220	32,87	32,16	32,16	22,74	22,74	8,72	7,30
10,0 x 330	15	340	240	33,00	33,00	33,00	23,33	23,33	8,72	7,30
10,0 x 360	15	360	260	33,00	33,00	33,00	23,33	23,33	8,72	7,30
10,0 x 400	15	400	280	33,00	33,00	33,00	23,33	23,33	8,72	7,30
10,0 x 450	15	460	320	33,00	33,00	33,00	23,33	23,33	8,72	7,30
10,0 x 500	15	500	360	33,00	33,00	33,00	23,33	23,33	8,72	7,30
10,0 x 550	15	560	400	33,00	33,00	33,00	23,33	23,33	8,72	7,30
10,0 x 600	15	600	420	33,00	33,00	33,00	23,33	23,33	8,72	7,30

Calculation according to ETA-11/0024. Wood density $\rho_k=380 \text{ kg/m}^3$. All mechanical values provided should be viewed as subject to the assumptions that have been made and represent example calculations.

All values are calculated minimum values and are subject to typographical and printing errors.

a) The characteristic values of the load-bearing capacity R_k cannot be treated as equivalent to the max. possible load (the max. force). Characteristic values of the load-bearing capacity R_k should be reduced to dimensioning values R_d with regard to the usage class and class of the load duration: $R_d=R_k \cdot k_{mod} / \gamma_M$. The dimensioning values of the load-bearing capacity R_d should be contrasted with the dimensioning values of the loads ($R_d \geq E_d$).

Example:

Characteristic value for constant load (dead weight) $G_k=2,00 \text{ kN}$ and variable load (e. g. snow load) $Q_k=3,00 \text{ kN}$. $k_{mod}=0,9$. $\gamma_M=1,3$. \rightarrow Dimensioning value of the load $E_d=2,00 \cdot 1,35 + 3,00 \cdot 1,5=7,20 \text{ kN}$. The load-bearing capacity of the joint is therefore considered to have been demonstrated if $R_d \geq E_d$. $\rightarrow \min R_k=R_d \cdot \gamma_M / k_{mod}$. i.e. the characteristic minimum value is calculated based on: $\min R_k=R_d \cdot \gamma_M / k_{mod} \rightarrow R_k=7,20 \text{ kN} \cdot 1,3/0,9=10,40 \text{ kN}$ \rightarrow comparison with table values.

Please note: These are planning aids. Projects must only be calculated by authorised persons.

KONSTRUX WITH COUNTERSUNK HEAD AND DRILL POINT OR AG TIP 11,3 MM: STEEL-TIMBER CONNECTION

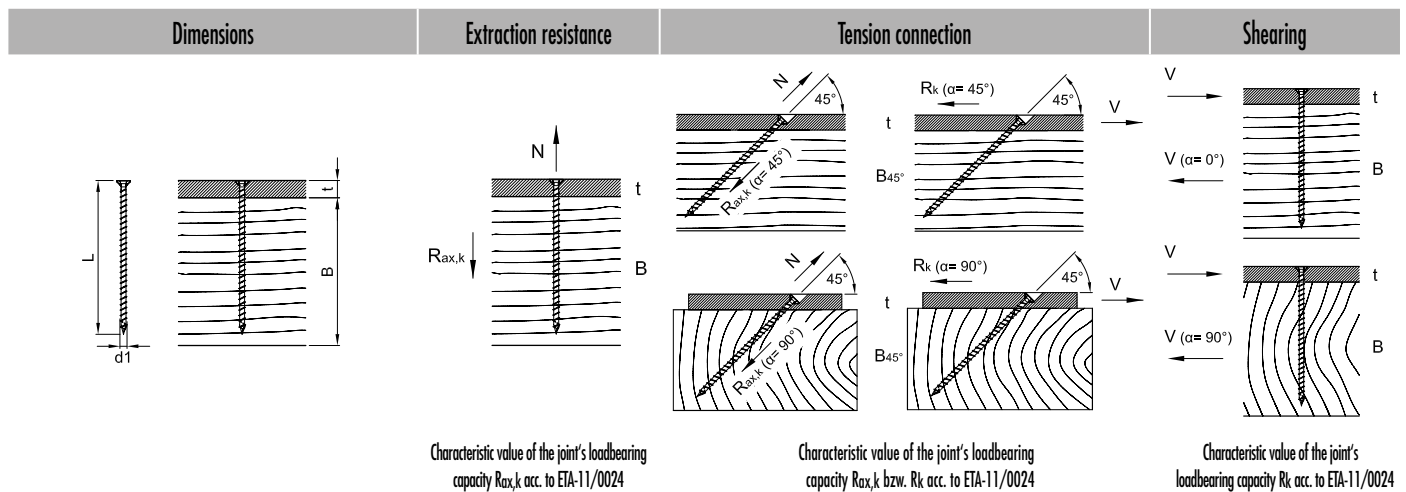

Characteristic value of the joint's loadbearing capacity $R_{ax,k}$ acc. to ETA-11/0024

Characteristic value of the joint's loadbearing capacity $R_{ax,k}$ bzw. R_k acc. to ETA-11/0024

Characteristic value of the joint's loadbearing capacity R_k acc. to ETA-11/0024

d1 x L [mm]	t [mm]	B [mm]	B45° [mm]	$R_{ax,k}^{a)}$ - [kN]	$R_{ax,k}^{a)}$ - [kN]		$R_k^{a)}$ - [kN]		$R_k^{a)}$ - [kN]	
					$\alpha=45^\circ$	$\alpha=90^\circ$	$\alpha=45^\circ$	$\alpha=90^\circ$	$\alpha=0^\circ$	$\alpha=90^\circ$
11,3 x 300	20	300	220	36,49	35,42	35,42	25,04	25,04	11,79	9,76
11,3 x 340	20	340	240	41,71	40,63	40,63	28,73	28,73	11,79	9,76
11,3 x 380	20	380	260	46,92	45,84	45,84	32,42	32,42	11,79	9,76
11,3 x 420	20	420	300	50,00	50,00	50,00	35,36	35,36	11,79	9,76
11,3 x 460	20	460	320	50,00	50,00	50,00	35,36	35,36	11,79	9,76
11,3 x 500	20	500	360	50,00	50,00	50,00	35,36	35,36	11,79	9,76
11,3 x 540	20	540	380	50,00	50,00	50,00	35,36	35,36	11,79	9,76
11,3 x 580	20	580	420	50,00	50,00	50,00	35,36	35,36	11,79	9,76
11,3 x 620	20	620	440	50,00	50,00	50,00	35,36	35,36	11,79	9,76
11,3 x 660	20	660	460	50,00	50,00	50,00	35,36	35,36	11,79	9,76
11,3 x 700	20	700	500	50,00	50,00	50,00	35,36	35,36	11,79	9,76
11,3 x 750	20	740	540	50,00	50,00	50,00	35,36	35,36	11,79	9,76
11,3 x 800	20	800	560	50,00	50,00	50,00	35,36	35,36	11,79	9,76
11,3 x 900	20	900	640	50,00	50,00	50,00	35,36	35,36	11,79	9,76
11,3 x 1000	20	1000	700	50,00	50,00	50,00	35,36	35,36	11,79	9,76

Calculation according to ETA-11/0024. Wood density $\rho_k=380 \text{ kg/m}^3$. All mechanical values provided should be viewed as subject to the assumptions that have been made and represent example calculations.

All values are calculated minimum values and are subject to typographical and printing errors.

a) The characteristic values of the load-bearing capacity R_k cannot be treated as equivalent to the max. possible load (the max. force). Characteristic values of the load-bearing capacity R_k should be reduced to dimensioning values R_d with regard to the usage class and class of the load duration: $R_d=R_k \cdot k_{mod} / \gamma_M$. The dimensioning values of the load-bearing capacity R_d should be contrasted with the dimensioning values of the loads ($R_d \geq E_d$).

Example:

Characteristic value for constant load (dead weight) $G_k=2,00 \text{ kN}$ and variable load (e. g. snow load) $Q_k=3,00 \text{ kN}$. $k_{mod}=0,9$. $\gamma_M=1,3$.

→ Dimensioning value of the load $E_d=2,00 \cdot 1,35 + 3,00 \cdot 1,5=7,20 \text{ kN}$.

The load-bearing capacity of the joint is therefore considered to have been demonstrated if $R_d \geq E_d$. → $\min R_k=R_d \cdot \gamma_M / k_{mod}$

i.e. the characteristic minimum value is calculated based on: $\min R_k=R_d \cdot \gamma_M / k_{mod} \rightarrow R_k=7,20 \text{ kN} \cdot 1,3/0,9=10,40 \text{ kN}$ → comparison with table values.

Please note: These are planning aids. Projects must only be calculated by authorised persons.

KONSTRUX ST WITH CYLINDER HEAD AND DRILL POINT 6,5 MM: MAIN-SECONDARY BEAM JOINTS

Dimensions **Main / secondary beam connection**

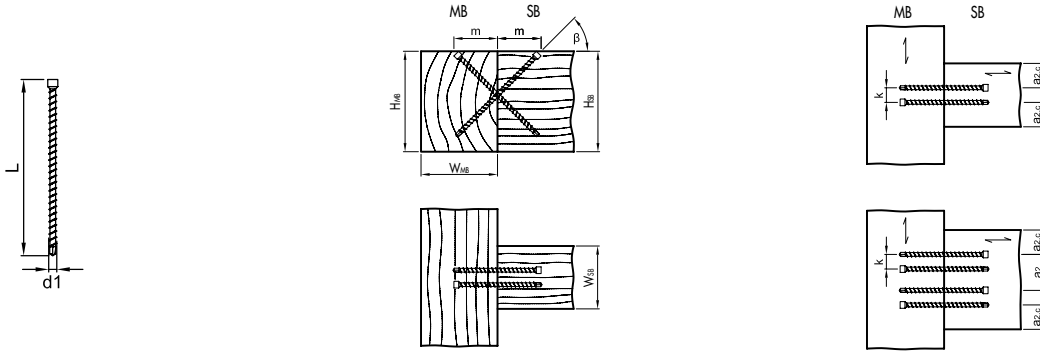

$a_2 = \text{min. } 33 \text{ mm}, a_{2c} = \text{min. } 20 \text{ mm}, k = \text{min. } 10 \text{ mm}$

Characteristic value of the joint's loadbearing capacity R_k acc. to ETA-11/0024

$d1 \times L$ [mm]	min. W_{MB} [mm]	min. H_{SB} [mm]	min. W_{MB} [mm]	min. H_{MB} [mm]	m [mm]	β °	$R_{v,k}$ a) b) - [kN]	Pair (n)
6,5 x 195	60						10,91	1
	100						20,36	2
	120	160	80	160	69	45	29,33	3
	160						38,00	4

Calculation according to ETA-11/0024. Wood density $\rho_k = 380 \text{ kg/m}^3$. All mechanical values provided should be viewed as subject to the assumptions that have been made and represent example calculations. All values are calculated minimum values and are subject to typographical and printing errors.

a) The characteristic values of the load-bearing capacity R_k cannot be treated as equivalent to the max. possible load (the max. force). Characteristic values of the load-bearing capacity R_k should be reduced to dimensioning values R_d with regard to the usage class and class of the load duration: $R_d = R_k \cdot k_{mod} / \gamma_M$. The dimensioning values of the load-bearing capacity R_d should be contrasted with the dimensioning values of the loads ($R_d \geq E_d$).

Example:

Characteristic value for constant load (dead weight) $G_k = 2,00 \text{ kN}$ and variable load (e. g. snow load) $Q_k = 3,00 \text{ kN}$. $k_{mod} = 0,9$. $\gamma_M = 1,3$.

→ Dimensioning value of the load $E_d = 2,00 \cdot 1,35 + 3,00 \cdot 1,5 = 7,20 \text{ kN}$.

The load-bearing capacity of the joint is therefore considered to have been demonstrated if $R_d \geq E_d$. → $\text{min } R_k = R_d \cdot \gamma_M / k_{mod}$

i.e. the characteristic minimum value is calculated based on: $\text{min } R_k = R_d \cdot \gamma_M / k_{mod} \rightarrow R_k = 7,20 \text{ kN} \cdot 1,3 / 0,9 = 10,40 \text{ kN}$ → comparison with table values.

b) estimated with an efficient quantity of pairs of screws: $n = 0,9$.

Please note: These are planning aids. Projects must only be calculated by authorised persons.

KONSTRUX ST WITH CYLINDER HEAD AND DRILL POINT 8,0 MM: MAIN-SECONDARY BEAM JOINTS

Dimensions

Main / secondary beam connection

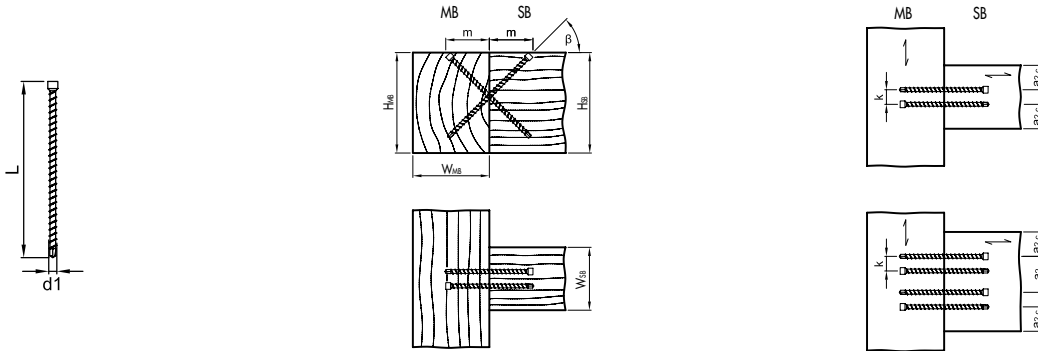

$a_2 = \text{min. } 40 \text{ mm}, a_{2,c} = \text{min. } 24 \text{ mm}, k = \text{min. } 12 \text{ mm}$

Characteristic value of the joint's loadbearing capacity R_k acc. to ETA-11/0024

$d1 \times L$ [mm]	min. W_{SB} [mm]	min. H_{SB} [mm]	min. W_{MB} [mm]	min. H_{MB} [mm]	m [mm]	β °	$R_{v,k}$ a) b) - [kN]	Pair (n)
8,0 x 245	80	200	100	200	87	45	16,43	1
	100						30,66	2
	140						44,16	3
	180						57,21	4
8,0 x 295	80	220	120	220	104	45	17,44	1
	100						32,55	2
	140						46,88	3
	180						60,74	4
8,0 x 330	80	260	140	260	117	45	17,44	1
	100						32,55	2
	140						46,88	3
	180						60,74	4
8,0 x 375	80	280	160	280	133	45	17,44	1
	100						32,55	2
	140						46,88	3
	180						60,74	4
8,0 x 400	80	300	160	300	141	45	17,44	1
	100						32,55	2
	140						46,88	3
	180						60,74	4
8,0 x 430	80	320	180	320	152	45	17,44	1
	100						32,55	2
	140						46,88	3
	180						60,74	4
8,0 x 480	80	360	180	360	170	45	17,44	1
	100						32,55	2
	140						46,88	3
	180						60,74	4

Calculation according to ETA-11/0024. Wood density $\rho_k = 380 \text{ kg/m}^3$. All mechanical values provided should be viewed as subject to the assumptions that have been made and represent example calculations.

All values are calculated minimum values and are subject to typographical and printing errors.

a) The characteristic values of the load-bearing capacity R_k cannot be treated as equivalent to the max. possible load (the max. force). Characteristic values of the load-bearing capacity R_k should be reduced to dimensioning values R_d with regard to the usage class and class of the load duration: $R_d = R_k \cdot k_{mod} / \gamma_M$. The dimensioning values of the load-bearing capacity R_d should be contrasted with the dimensioning values of the loads ($R_d \geq E_d$).

Example:

Characteristic value for constant load (dead weight) $G_k = 2,00 \text{ kN}$ and variable load (e. g. snow load) $Q_k = 3,00 \text{ kN}$. $k_{mod} = 0,9$. $\gamma_M = 1,3$.

→ Dimensioning value of the load $E_d = 2,00 \cdot 1,35 + 3,00 \cdot 1,5 = 7,20 \text{ kN}$.

The load-bearing capacity of the joint is therefore considered to have been demonstrated if $R_d \geq E_d$. → $\text{min } R_k = R_d \cdot \gamma_M / k_{mod}$

i.e. the characteristic minimum value is calculated based on: $\text{min } R_k = R_d \cdot \gamma_M / k_{mod} \rightarrow R_k = 7,20 \text{ kN} \cdot 1,3 / 0,9 = 10,40 \text{ kN}$ → comparison with table values.

b) estimated with an efficient quantity of pairs of screws: $n^{0,9}$.

Please note: These are planning aids. Projects must only be calculated by authorised persons.

KONSTRUX ST WITH CYLINDER HEAD AND DRILL POINT 10,0 MM: MAIN-SECONDARY BEAM JOINTS

Dimensions **Main / secondary beam connection**

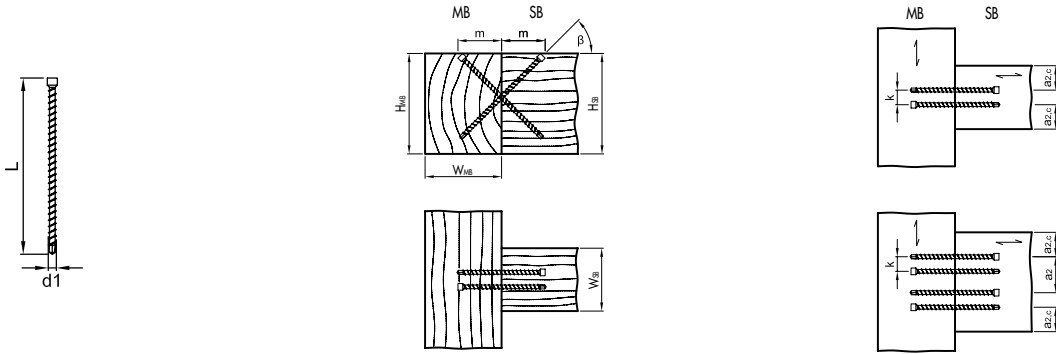

$a_2 = \text{min. } 50 \text{ mm}, a_{2,c} = \text{min. } 30 \text{ mm}, k = \text{min. } 15 \text{ mm}$

Characteristic value of the joint's loadbearing capacity R_k acc. to ETA-11/0024

d1 x L [mm]	min. W _{MB} [mm]	min. H _{SB} [mm]	min. W _{MB} [mm]	min. H _{MB} [mm]	m [mm]	β °	R _{v,k} a) b) - [kN]	Pair (n)
10,0 x 300	80	240	120	240	106	45	23,67	1
	140						44,18	2
	180						63,63	3
	240						82,44	4
10,0 x 330	80	260	140	260	117	45	23,67	1
	140						44,18	2
	180						63,63	3
	240						82,44	4
10,0 x 360	80	280	140	280	127	45	23,67	1
	140						44,18	2
	180						63,63	3
	240						82,44	4
10,0 x 400	80	300	160	300	141	45	23,67	1
	140						44,18	2
	180						63,63	3
	240						82,44	4
10,0 x 450	80	340	180	340	159	45	23,67	1
	140						44,18	2
	180						63,63	3
	240						82,44	4
10,0 x 500	80	380	200	380	177	45	23,67	1
	140						44,18	2
	180						63,63	3
	240						82,44	4
10,0 x 550	80	400	220	400	194	45	23,67	1
	140						44,18	2
	180						63,63	3
	240						82,44	4
10,0 x 600	80	440	240	440	212	45	23,67	1
	140						44,18	2
	180						63,63	3
	240						82,44	4

Calculation according to ETA-11/0024. Wood density $\rho_k = 380 \text{ kg/m}^3$. All mechanical values provided should be viewed as subject to the assumptions that have been made and represent example calculations.

All values are calculated minimum values and are subject to typographical and printing errors.

a) The characteristic values of the load-bearing capacity R_k cannot be treated as equivalent to the max. possible load (the max. force). Characteristic values of the load-bearing capacity R_k should be reduced to dimensioning values R_d with regard to the usage class and class of the load duration: $R_d = R_k \cdot k_{mod} / \gamma_M$. The dimensioning values of the load-bearing capacity R_d should be contrasted with the dimensioning values of the loads ($R_d \geq E_d$).

Example:

Characteristic value for constant load (dead weight) $G_k = 2,00 \text{ kN}$ and variable load (e. g. snow load) $Q_k = 3,00 \text{ kN}$. $k_{mod} = 0,9$. $\gamma_M = 1,3$.

→ Dimensioning value of the load $E_d = 2,00 \cdot 1,35 + 3,00 \cdot 1,5 = 7,20 \text{ kN}$.

The load-bearing capacity of the joint is therefore considered to have been demonstrated if $R_d \geq E_d$. → $\text{min } R_k = R_d \cdot \gamma_M / k_{mod}$

i.e. the characteristic minimum value is calculated based on: $\text{min } R_k = R_d \cdot \gamma_M / k_{mod} \rightarrow R_k = 7,20 \text{ kN} \cdot 1,3 / 0,9 = 10,40 \text{ kN}$ → comparison with table values.

b) estimated with an efficient quantity of pairs of screws: $n^{0,9}$.

Please note: These are planning aids. Projects must only be calculated by authorised persons.

KONSTRUX ST WITH CYLINDER HEAD 6,5 MM

GEOMETRY AND MECHANICAL PROPERTIES

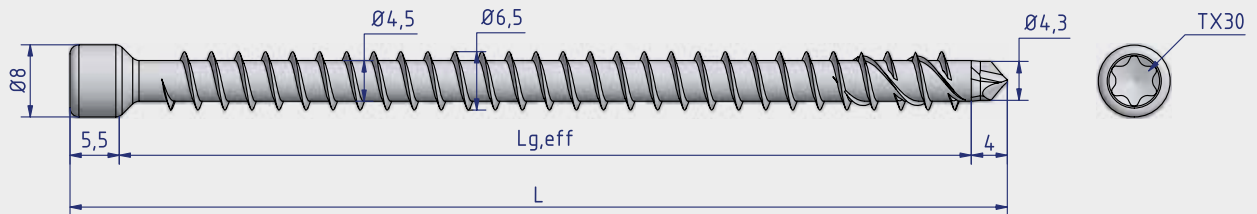

KonstruX ST-ZK Ø6,5xL -TX30

Art. no.	L [mm]	L _{g,eff} [mm]	PU	Pre-drilling diameter Ød _v [mm]	Characteristic pull-out resistance value f _{ax,k} [N/mm ²]	Characteristic tensile strength value f _{tens,k} [kN]	Characteristic yield moment M _{y,k} [Nmm]	Characteristic yield strength f _{y,k} [N/mm ²]
904808	80	71	100	4,5	11,4	17,0	15000	1000
904809	100	91	100	4,5	11,4	17,0	15000	1000
904810	120	111	100	4,5	11,4	17,0	15000	1000
904811	140	131	100	4,5	11,4	17,0	15000	1000
904812	160	151	100	4,5	11,4	17,0	15000	1000
904813	195	186	100	4,5	11,4	17,0	15000	1000

Please note: Verify the assumptions made. The stated values, and type and number of joining devices are based on preliminary measurements. Projects are to be dimensioned exclusively by authorised persons in accordance with the State Building Code. As per LBauO, please contact a qualified structural engineer for a paid proof of stability. We will be happy to refer you to someone.

Axial and edge distances

The minimum distances for KonstruX loaded exclusively in the axial direction in pre-drilled and non-pre-drilled holes in components measuring min. $t = 65$ thick and min. 60 mm wide must be selected as follows

Axial distance parallel to the direction of the grain	a_1	[mm]	$5 \cdot d$	33
Axial distance perpendicular to the direction of the grain	a_2	[mm]	$5 \cdot d$	33
Distance from the centre of gravity of the screw area driven into the wood from the end grain surface	$a_{1,c}$	[mm]	$5 \cdot d$	33
Distance from the centre of gravity of the screw area driven into the wood from the side grain surface	$a_{2,c}$	[mm]	$3 \cdot d$	20
Axial distance between a crossing pair of screws	$a_{2,k}$	[mm]	$1,5 \cdot d$	10
Reduced axial distance a_2 perpendicular to the direction of the grain, if $a_1 \cdot a_2 \geq 25 \cdot d^2$	$a_{2,red}$	[mm]	$2,5 \cdot d$	16

The axial and edge distances are minimum distances according to DIN EN 1995:2014 (EC5) and generally apply to fasteners subjected to transverse loads

a_1 Distance from the fasteners within a row in the direction of the grain

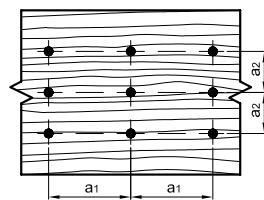

a_2 Distance from the fasteners perpendicular to the direction of the grain

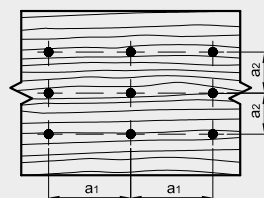

$a_{3,c}$ Distance between the fastener and the unloaded end of the end grain $90^\circ \leq \alpha \leq 270^\circ$

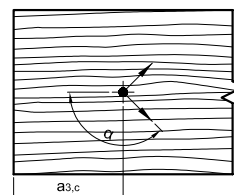

$a_{3,t}$ Distance between the fastener and the loaded end of the end grain $-90^\circ \leq \alpha \leq 90^\circ$

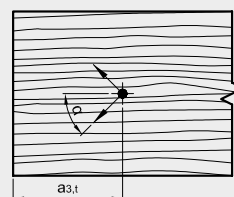

$a_{4,c}$ Distance between the fastener and the unloaded edge $180^\circ \leq \alpha \leq 360^\circ$

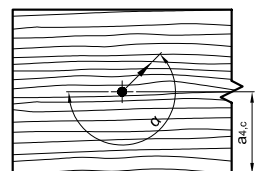

$a_{4,t}$ Distance between the fastener and the loaded edge $0^\circ \leq \alpha \leq 180^\circ$

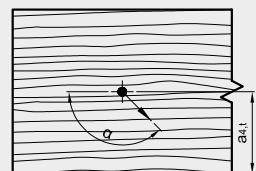

When analysed, the minimum distances for KonstruX screws in pre-drilled holes that are loaded in a crosswise direction are as follows according to the position of the direction of the grain

Minimum distances for KonstruX screws in pre-drilled holes that are loaded in a crosswise direction with a force / fibre angle of 0° and 90°

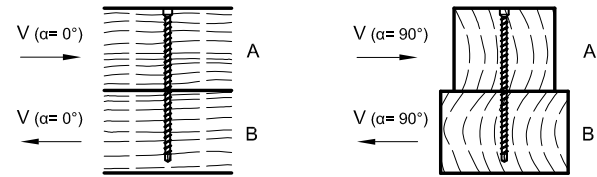

			Force / fibre angle $\alpha = 0^\circ$		Force / fibre angle $\alpha = 90^\circ$	
Axial distance parallel to the direction of the grain	a_1	[mm]	$5 \cdot d$	33	$4 \cdot d$	33
Axial distance perpendicular to the direction of the grain	a_2	[mm]	$3 \cdot d$	20	$4 \cdot d$	33
Distance from the centre of gravity of the screw area driven into the wood from the unloaded end of the end grain	$a_{3,c}$	[mm]	$7 \cdot d$	46	$7 \cdot d$	46
Distance from the centre of gravity of the screw area driven into the wood from the loaded end of the end grain	$a_{3,t}$	[mm]	$12 \cdot d$	78	$7 \cdot d$	46
Axial distance perpendicular to the unloaded edge	$a_{4,c}$	[mm]	$3 \cdot d$	20	$3 \cdot d$	20
Axial distance from the loaded edge	$a_{4,t}$	[mm]	$3 \cdot d$	20	$7 \cdot d$	46

When analysed, the minimum distances for KonstruX in non-pre-drilled holes, loaded in a crosswise direction, are as follows according to the position of the direction of the grain

Minimum distances for KonstruX screws in non-pre-drilled holes that are loaded in a crosswise direction with a force / fibre angle of 0° and 90°

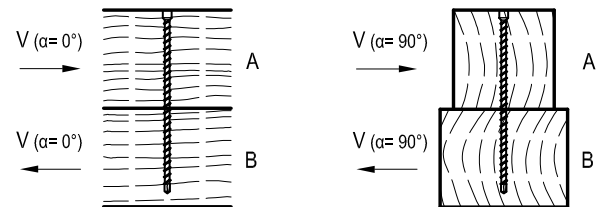

			Force / fibre angle $\alpha = 0^\circ$		Force / fibre angle $\alpha = 90^\circ$	
Axial distance parallel to the direction of the grain	a_1	[mm]	$12 \cdot d$	78	$5 \cdot d$	33
Axial distance perpendicular to the direction of the grain	a_2	[mm]	$5 \cdot d$	33	$5 \cdot d$	33
Distance from the centre of gravity of the screw area driven into the wood from the unloaded end of the end grain	$a_{3,c}$	[mm]	$10 \cdot d$	65	$10 \cdot d$	65
Distance from the centre of gravity of the screw area driven into the wood from the loaded end of the end grain	$a_{3,t}$	[mm]	$15 \cdot d$	98	$10 \cdot d$	65
Axial distance perpendicular to the unloaded edge	$a_{4,c}$	[mm]	$5 \cdot d$	33	$5 \cdot d$	33
Axial distance from the loaded edge	$a_{4,t}$	[mm]	$5 \cdot d$	33	$10 \cdot d$	65

Please note: Verify the assumptions made. The stated values, and type and number of joining devices are based on preliminary measurements. Projects are to be dimensioned exclusively by authorised persons in accordance with the State Building Code. As per LBauO, please contact a qualified structural engineer for a paid proof of stability. We will be happy to refer you to someone.

KONSTRUX ST WITH CYLINDER HEAD AND DRILL POINT 6,5 MM: SHEARING STRENGTH RATIO WITHOUT PRE-DRILLING

Dimensionsen Axial pull-out load capacity Shearing strength ratio without pre-drilling

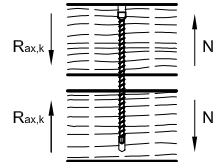
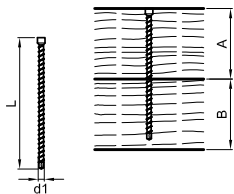

Characteristic value of the joint's loadbearing capacity $R_{ax,k}$ nach ETA-11/0024

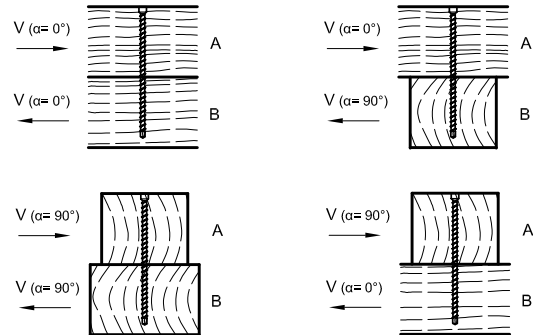

Characteristic value of the joint's loadbearing capacity R_k to ETA-11/0024

Ød1 x L [mm]	A [mm]	B [mm]	$R_{ax,k}^{a)}$ - [kN]	$R_k^{a)}$ - [kN]		$R_k^{a)}$ - [kN]		$R_k^{a)}$ - [kN]	
				$\alpha=0^\circ$	$\alpha=90^\circ$	$\alpha_A=0^\circ$ $\alpha_B=90^\circ$	$\alpha_A=90^\circ$ $\alpha_B=0^\circ$		
6,5 x 120	60	80	4,35	3,83	3,37	3,83	3,37	3,83	3,37
6,5 x 140	80	80	4,43	3,85	3,39	3,39	3,85	3,39	3,85
6,5 x 160	80	100	5,94	4,22	3,76	4,22	3,76	4,22	3,76
6,5 x 195	100	100	7,20	4,54	4,08	4,08	4,54	4,08	4,54

Calculation according to ETA-11/0024. Wood density $\rho_k=380 \text{ kg/m}^3$. All mechanical values provided should be viewed as subject to the assumptions that have been made and represent example calculations.

All values are calculated minimum values and are subject to typographical and printing errors.

a) The characteristic values of the load-bearing capacity R_k cannot be treated as equivalent to the max. possible load (the max. force). Characteristic values of the load-bearing capacity R_k should be reduced to dimensioning values R_d with regard to the usage class and class of the load duration: $R_d = R_k \cdot k_{mod} / \gamma_M$. The dimensioning values of the load-bearing capacity R_d should be contrasted with the dimensioning values of the loads ($R_d \geq E_d$).

KONSTRUX ST WITH CYLINDER HEAD AND DRILL POINT 6,5 MM: AXIAL PULL-OUT LOAD CAPACITY WITHOUT PRE-DRILLING

Dimensions Axial pull-out load capacity without pre-drilling

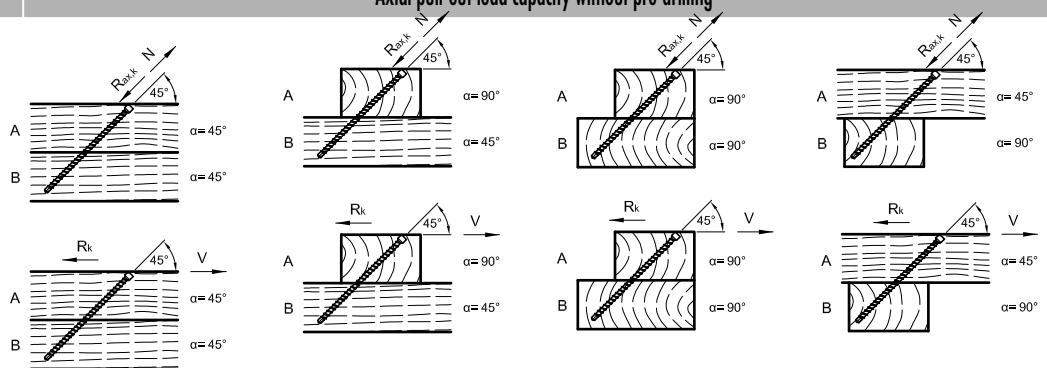
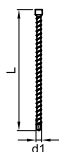

Characteristic value of the joint's loadbearing capacity R_k acc. to ETA-11/0024

Ød1 x L [mm]	A [mm]	B [mm]	$R_{ax,k}^{a)}$ - [kN]		$R_k^{a)}$ - [kN]		$R_{ax,k}^{a)}$ - [kN]		$R_k^{a)}$ - [kN]	
			$\alpha=45^\circ$	$\alpha=45^\circ$	$\alpha_A=90^\circ$ $\alpha_B=45^\circ$	$\alpha_A=90^\circ$ $\alpha_B=90^\circ$	$\alpha_A=45^\circ$ $\alpha_B=90^\circ$	$\alpha_A=45^\circ$ $\alpha_B=90^\circ$		
6,5 x 160	60	80	5,51	3,90	5,51	3,90	5,51	3,90	5,51	3,90
6,5 x 195	80	80	6,04	4,27	6,04	4,27	6,04	4,27	6,04	4,27

Calculation according to ETA-11/0024. Wood density $\rho_k=380 \text{ kg/m}^3$. All mechanical values provided should be viewed as subject to the assumptions that have been made and represent example calculations.

All values are calculated minimum values and are subject to typographical and printing errors.

a) The characteristic values of the load-bearing capacity R_k cannot be treated as equivalent to the max. possible load (the max. force). Characteristic values of the load-bearing capacity R_k should be reduced to dimensioning values R_d with regard to the usage class and class of the load duration: $R_d = R_k \cdot k_{mod} / \gamma_M$. The dimensioning values of the load-bearing capacity R_d should be contrasted with the dimensioning values of the loads ($R_d \geq E_d$).

KONSTRUX ST WITH CYLINDER HEAD AND DRILL POINT 6,5 MM: MAIN-SECONDARY BEAM JOINTS

Dimensions

Main/secondary beam connection

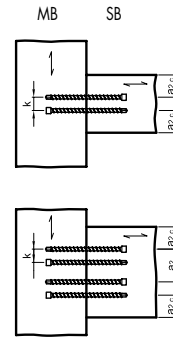
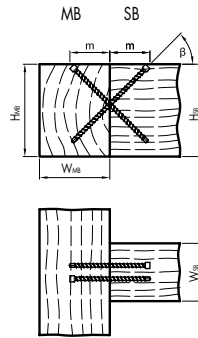
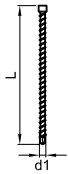

$a_2 = \text{min. } 33 \text{ mm}$, $a_{2,c} = \text{min. } 20 \text{ mm}$, $k = \text{min. } 10 \text{ mm}$

Characteristic value of the joint's
loadbearing capacity $R_{v,k}$ acc. to ETA-11/0024

$d1 \times L$ [mm]	min. W_{SB} [mm]	min. H_{SB} [mm]	min. W_{MB} [mm]	min. H_{MB} [mm]	m [mm]	β °	$R_{v,k}$ a) b) - [kN]	Pair (n)
6,5 x 195	60	160	80	160	69	45	10,91	1
	100						20,36	2
	120						29,33	3
	160						38,00	4

Calculation according to ETA-11/0024. Wood density $\rho_k = 380 \text{ kg/m}^3$. All mechanical values provided should be viewed as subject to the assumptions that have been made and represent example calculations. All values are calculated minimum values and are subject to typographical and printing errors.

a) The characteristic values of the load-bearing capacity R_k cannot be treated as equivalent to the max. possible load (the max. force). Characteristic values of the load-bearing capacity R_k should be reduced to dimensioning values R_d with regard to the usage class and class of the load duration: $R_d = R_k \cdot k_{mod} / \gamma_M$. The dimensioning values of the load-bearing capacity R_d should be contrasted with the dimensioning values of the loads ($R_d \geq E_d$).

Please note: Verify the assumptions made. The stated values, and type and number of joining devices are based on preliminary measurements. Projects are to be dimensioned exclusively by authorised persons in accordance with the State Building Code. As per LBau0, please contact a qualified structural engineer for a paid proof of stability. We will be happy to refer you to someone.

ANGLE-BRACKET SCREW (ABS)



ADVANTAGES

- Quick and easy screwing-in
- Reduced splitting effect
- National and international approvals

DESCRIPTION

The Eurotec Angle-bracket screw (ABS) is made of hardened carbon steel and is specially designed for joints between steel sheet and wood. The splitting effect in the wood is reduced by the geometry of the screw tip. In addition, the screw is characterized, among other things, by the smooth shank under the head, which allows load transfer during shearing.

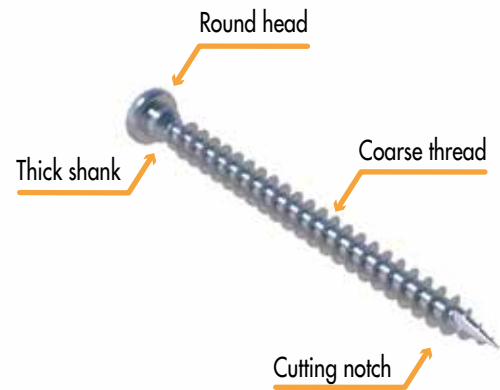

Angle-bracket mounted in CLT system angle.

Angle-bracket screw

Blue galvanised



Art. no.	Dimensions [mm]	Drive	PU
945343	5,0 x 25	TX20	250
945232	5,0 x 35	TX20	250
945241	5,0 x 40	TX20	250
945233	5,0 x 50	TX20	250
945344	5,0 x 60	TX20	250
945345	5,0 x 70	TX20	250

TECHNICAL INFORMATIONS

ANGLE-BRACKET SCREW, STEEL BLUE GALVANISED

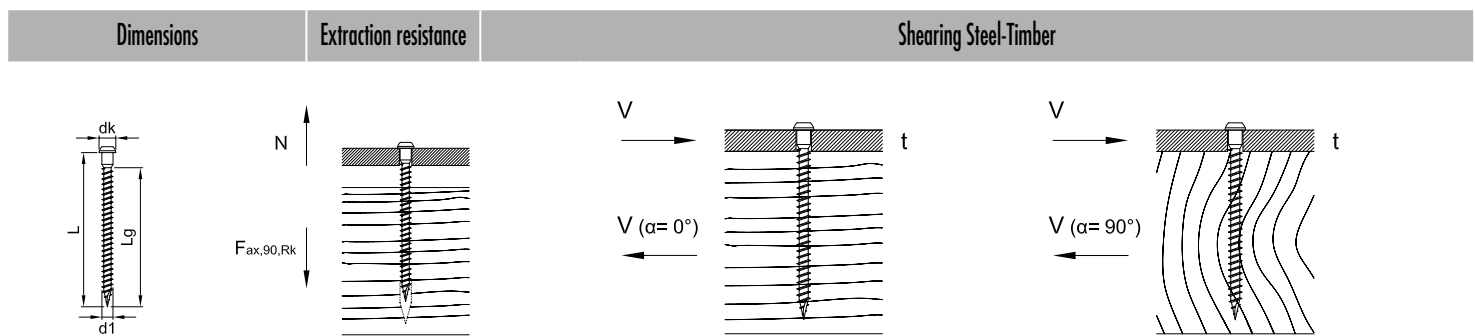

d1 x L [mm]	dk [mm]	Lg [mm]	F _{ax,90,Rk} [kN]	t [mm]	R _k [kN]	t [mm]	R _k [kN]	t [mm]	R _k [kN]	t [mm]	R _k [kN]	t [mm]	R _k [kN]
			t ≤ 9,0 [mm]		α=0°		α=0°		α=0°		α=0°		α=0°
					α=90°		α=90°		α=90°		α=90°		α=90°
5,0 x 25		16	0,97		0,89		0,87		0,85		0,96		1,18
5,0 x 35		26	1,57		1,27		1,25		1,23		1,35		1,59
5,0 x 40	7,2	31	1,88	1,5	1,46	2,0	1,44	2,5	1,42	3,0	1,55	4,0	1,81
5,0 x 50		41	2,48		1,84		1,82		1,80		1,89		2,10
5,0 x 60		51	3,09		1,99		1,99		1,99		2,09		2,29
5,0 x 70		61	3,69		2,14		2,14		2,14		2,24		2,44

Calculation according to ETA-11/0024. Wood density $\rho_k = 350 \text{ kg/m}^3$. All mechanical values provided should be viewed as subject to the assumptions that have been made and represent example calculations.

All values are calculated minimum values. Typesetting and printing errors are excepted.

a) The characteristic values of the load-bearing capacity R_k should not be treated as equivalent to the max. possible load (the max. force). Characteristic values of the load-bearing capacity R_k are to be reduced to the design values R_d as regards the service class and class of the load duration: $R_d = R_k \cdot k_{mod} / \gamma_M$. The design values of the load-bearing capacity R_d should be compared to the design values of the loads ($R_d \geq E_d$).

Example:

Characteristic value for constant load (dead load) $G_k = 2,00 \text{ kN}$ and variable load (e.g. snow load) $Q_k = 3,00 \text{ kN}$. $k_{mod} = 0,9$. $\gamma_M = 1,3$.

→ Rated value of the load $E_d = 2,00 \cdot 1,35 + 3,00 \cdot 1,5 = 7,20 \text{ kN}$.

Load-bearing capacity of the connection is proved if $R_d \geq E_d$. → $\min R_k = R_d \cdot \gamma_M / k_{mod}$

That is, the characteristic minimum value of the load-bearing capacity is calculated as: $\min R_k = R_d \cdot \gamma_M / k_{mod} \rightarrow R_k = 7,20 \text{ kN} \cdot 1,3/0,9 = 10,40 \text{ kN}$ → Aligned with table values.

Please note: These are planning aids. Projects must only be calculated by authorised persons.

Please note: Verify the assumptions made. The stated values, and type and number of joining devices are based on preliminary measurements. Projects are to be dimensioned exclusively by authorised persons in accordance with the State Building Code. As per LBauO, please contact a qualified structural engineer for a paid proof of stability. We will be happy to refer you to someone.

PANELTWISTEC



ADVANTAGES

- Quick and easy screwing-in
- Reduced splitting effect
- National and international approvals
- Due to the special coating, the screw has a higher corrosion resistance than conventional galvanizing
- Can be used in service classes 1 and 2
- Free of chromium (VI) oxide
- Resistant to mechanical stress
- Prevents contact corrosion with attachments
- No hammering of the screws when screwing in due to TX-Drive

DESCRIPTION

Panelwistec wood construction screws may generally be installed in CLT without predrilling. The Panelwistec is a wood construction screw with a special screw tip and milling ribs above the thread. The cutting notch on the screw tip ensures fast gripping and less splitting effect when screwing in. The Panelwistec AG instead features a folded-down thread, which reduces the screw-in torque. Panelwistec wood construction screws are available in both countersunk head and flanged button-head variants, as well as made of coated carbon steels and various stainless steels.

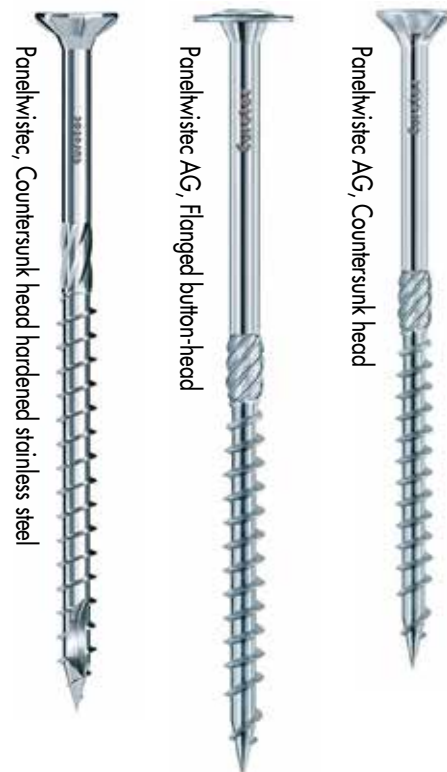
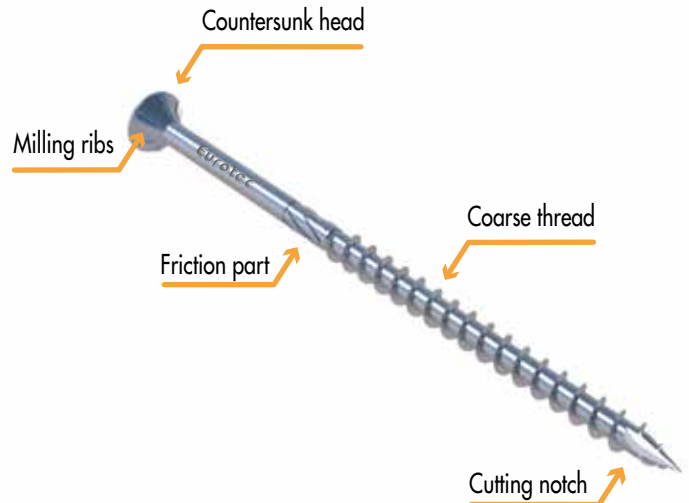

Paneltwistec AG

Countersunk head, blue galvanised



Art. no.	Dimensions [mm]	Drive	PU
945436	3,5 x 30	TX15 ●	1000
945838	3,5 x 35	TX15 ●	1000
945437	3,5 x 40	TX15 ●	1000
945490	3,5 x 50	TX15 ●	500
945491	4,0 x 30	TX20 ●	1000
945836	4,0 x 35	TX20 ●	1000
945492	4,0 x 40	TX20 ●	1000
945493	4,0 x 45	TX20 ●	500
945494	4,0 x 50	TX20 ●	500
945495	4,0 x 60	TX20 ●	200
945496	4,0 x 70	TX20 ●	200
945497	4,0 x 80	TX20 ●	200
945498	4,5 x 40	TX25 ●	500
945888	4,5 x 45	TX25 ●	500
945499	4,5 x 50	TX25 ●	500
945567	4,5 x 60	TX25 ●	200
945568	4,5 x 70	TX25 ●	200
945569	4,5 x 80	TX25 ●	200
945574	5,0 x 40	TX25 ●	200
945837	5,0 x 45	TX25 ●	200
945575	5,0 x 50	TX25 ●	200
945576	5,0 x 60	TX25 ●	200
945577	5,0 x 70	TX25 ●	200
945578	5,0 x 80	TX25 ●	200
945579	5,0 x 90	TX25 ●	200
945580	5,0 x 100	TX25 ●	200
945581	5,0 x 120	TX25 ●	200
945583	6,0 x 60	TX30 ●	200
945584	6,0 x 70	TX30 ●	200
945632	6,0 x 80	TX30 ●	200
945633	6,0 x 90	TX30 ●	100
945634	6,0 x 100	TX30 ●	100
945635	6,0 x 110	TX30 ●	100
945636	6,0 x 120	TX30 ●	100
945637	6,0 x 130	TX30 ●	100
945638	6,0 x 140	TX30 ●	100
945639	6,0 x 150	TX30 ●	100
945640	6,0 x 160	TX30 ●	100
945641	6,0 x 180	TX30 ●	100
945642	6,0 x 200	TX30 ●	100
945643	6,0 x 220	TX30 ●	100
945644	6,0 x 240	TX30 ●	100
945645	6,0 x 260	TX30 ●	100
945646	6,0 x 280	TX30 ●	100
945647	6,0 x 300	TX30 ●	100



Paneltwistec AG for fastening support battens.

Paneltwistec AG

Countersunk head, blue galvanised



Art. no.	Dimensions [mm]	Drive	PU
944715	8,0 x 80	TX40 ●	50
944716	8,0 x 100	TX40 ●	50
944717	8,0 x 120	TX40 ●	50
944718	8,0 x 140	TX40 ●	50
944719	8,0 x 160	TX40 ●	50
944720	8,0 x 180	TX40 ●	50
944721	8,0 x 200	TX40 ●	50
944722	8,0 x 220	TX40 ●	50
944723	8,0 x 240	TX40 ●	50
944724	8,0 x 260	TX40 ●	50
944725	8,0 x 280	TX40 ●	50
944726	8,0 x 300	TX40 ●	50
944727	8,0 x 320	TX40 ●	50
944728	8,0 x 340	TX40 ●	50
944729	8,0 x 360	TX40 ●	50
944730	8,0 x 380	TX40 ●	50
944731	8,0 x 400	TX40 ●	50
944732	8,0 x 420	TX40 ●	25
944733	8,0 x 440	TX40 ●	25
944734	8,0 x 460	TX40 ●	25
944735	8,0 x 480	TX40 ●	25
944736	8,0 x 500	TX40 ●	25
944737	8,0 x 550	TX40 ●	25
944739	8,0 x 600	TX40 ●	25
945687	10 x 100	TX50 ●	50
945688	10 x 120	TX50 ●	50
945689	10 x 140	TX50 ●	50
945690	10 x 160	TX50 ●	50
945691	10 x 180	TX50 ●	50
945692	10 x 200	TX50 ●	50
945693	10 x 220	TX50 ●	50
945694	10 x 240	TX50 ●	50
945695	10 x 260	TX50 ●	50
945696	10 x 280	TX50 ●	50
945697	10 x 300	TX50 ●	50
945698	10 x 320	TX50 ●	50
945699	10 x 340	TX50 ●	50
945703	10 x 360	TX50 ●	50
945709	10 x 380	TX50 ●	50
945711	10 x 400	TX50 ●	50



Klimax for fastening insulation material.

TECHNICAL INFORMATION

PANELTWISTEC AG, COUNTERSUNK-HEAD, BLUE GALVANISED

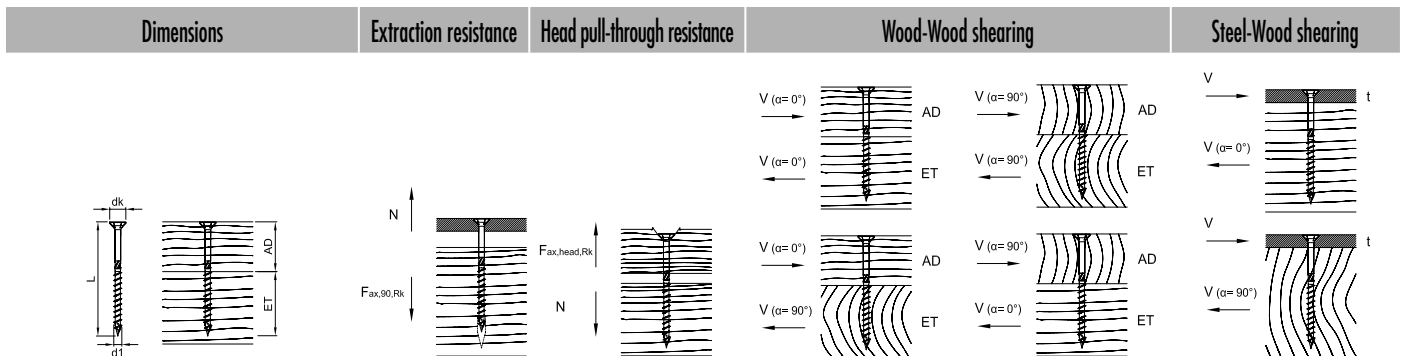

d1 x L [mm]	dk [mm]	AD [mm]	ET [mm]	F _{ax,90,Rk} [kN]	F _{ax,head,Rk} [kN]	Wood-Wood shearing				Steel-Wood shearing	
						F _{l0,Rk} [kN]	F _{l90,Rk} [kN]	F _{l0,Rk} [kN]	F _{l90,Rk} [kN]	t [mm]	F _{l0,Rk} [kN]
						α=0°		αAD=0° αET=90°			
						α=90°		αAD=90° αET=0°			
3,5 x 30	7,0	12	18	0,84	0,59			0,62		1	0,86
3,5 x 35	7,0	14	21	0,98	0,59			0,67		1	0,92
3,5 x 40	7,0	16	24	1,12	0,59			0,70		1	0,95
3,5 x 45	7,0	18	27	1,26	0,59			0,74		1	0,99
3,5 x 50	7,0	20	30	1,40	0,59			0,78		1	1,02
4,0 x 30	8,0	12	18	0,93	0,77			0,71		2	0,91
4,0 x 35	8,0	14	21	1,08	0,77			0,80		2	1,07
4,0 x 40	8,0	16	24	1,24	0,77			0,84		2	1,15
4,0 x 45	8,0	18	27	1,39	0,77			0,88		2	1,19
4,0 x 50	8,0	20	30	1,55	0,77			0,92		2	1,23
4,0 x 60	8,0	24	36	1,86	0,77			1,01		2	1,31
4,0 x 70	8,0	28	42	2,17	0,77			1,03		2	1,38
4,0 x 80	8,0	32	48	2,48	0,77			1,03		2	1,46
4,5 x 40	9,0	16	24	1,35	0,97			1,00		2	1,34
4,5 x 45	9,0	18	27	1,52	0,97			1,03		2	1,40
4,5 x 50	9,0	20	30	1,69	0,97			1,08		2	1,44
4,5 x 60	9,0	24	36	2,03	0,97			1,17		2	1,53
4,5 x 70	9,0	28	42	2,36	0,97			1,26		2	1,61
4,5 x 80	9,0	32	48	2,70	0,97			1,26		2	1,70
5,0 x 40	10,0	16	24	1,45	1,20			1,11		2	1,44
5,0 x 45	10,0	18	27	1,63	1,20			1,20		2	1,62
5,0 x 50	10,0	20	30	1,82	1,20			1,24		2	1,67
5,0 x 60	10,0	24	36	2,18	1,20			1,34		2	1,76
5,0 x 70	10,0	28	42	2,54	1,20			1,44		2	1,85
5,0 x 80	10,0	32	48	2,90	1,20			1,52		2	1,94
5,0 x 90	10,0	36	54	3,27	1,20			1,52		2	2,03
5,0 x 100	10,0	40	60	3,63	1,20			1,52		2	2,12
5,0 x 120	10,0	50	70	4,24	1,20			1,52		2	2,27

Calculation according to ETA-11/0024. Wood density $\rho_k = 350 \text{ kg/m}^3$. All mechanical values provided should be viewed as subject to the assumptions that have been made and represent example calculations.

All values are calculated minimum values and are subject to typographical and printing errors.

a) The characteristic values of the load-bearing capacity R_k cannot be treated as equivalent to the max. possible load (the max. force). Characteristic values of the load-bearing capacity R_k should be reduced to dimensioning values R_d with regard to the usage class and class of the load duration: $R_d = R_k \cdot k_{mod} / \gamma_M$. The dimensioning values of the load-bearing capacity R_d should be contrasted with the dimensioning values of the loads ($R_d \geq E_d$).

Example:

Characteristic value for constant load (dead weight) $G_k = 2,00 \text{ kN}$ and variable load (e. g. snow load) $Q_k = 3,00 \text{ kN}$. $k_{mod} = 0,9$. $\gamma_M = 1,3$.

→ Dimensioning value of the load $E_d = 2,00 \cdot 1,35 + 3,00 \cdot 1,5 = 7,20 \text{ kN}$.

The load-bearing capacity of the joint is therefore considered to have been demonstrated if $R_d \geq E_d$. → $\min R_k = R_d \cdot \gamma_M / k_{mod}$

i.e. the characteristic minimum value is calculated based on: $\min R_k = R_d \cdot \gamma_M / k_{mod} \rightarrow R_k = 7,20 \text{ kN} \cdot 1,3 / 0,9 = 10,40 \text{ kN}$ → comparison with table values.

Please note: These are planning aids. Projects must only be calculated by authorised persons.

Please note: Verify the assumptions made. The stated values, and type and number of joining devices are based on preliminary measurements. Projects are to be dimensioned exclusively by authorised persons in accordance with the State Building Code. As per LBauO, please contact a qualified structural engineer for a paid proof of stability. We will be happy to refer you to someone.

Dimensions	Extraction resistance	Head pull-through resistance	Wood-Wood shearing				Steel-Wood shearing	
------------	-----------------------	------------------------------	--------------------	--	--	--	---------------------	--

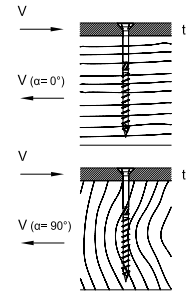
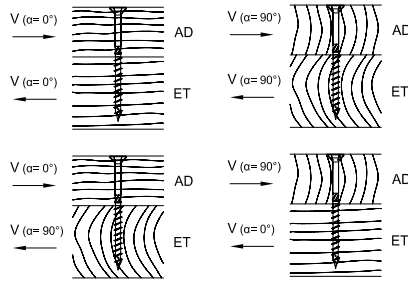
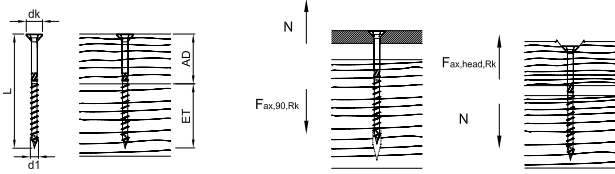

d1 x L [mm]	dk [mm]	AD [mm]	ET [mm]	Fax,90,Rk [kN]	Fax,head,Rk [kN]	Fla,Rk [kN]		Fla,Rk [kN]		t [mm]	Fla,Rk [kN]	
						alpha=0°	alpha=90°	alphaAD=0°			alpha=0°	alpha=90°
								alphaET=90°	alphaET=0°			
6,0 x 60	12,0	24	36	2,46	1,73			1,71		2	2,26	
6,0 x 70	12,0	28	42	2,87	1,73			1,82		2	2,36	
6,0 x 80	12,0	32	48	3,28	1,73			1,93		2	2,46	
6,0 x 90	12,0	36	54	3,69	1,73			2,05		2	2,57	
6,0 x 100	12,0	40	60	4,10	1,73			2,07		2	2,67	
6,0 x 110	12,0	40	70	4,79	1,73			2,07		2	2,84	
6,0 x 120	12,0	50	70	4,79	1,73			2,07		2	2,84	
6,0 x 130	12,0	60	70	4,79	1,73			2,07		2	2,84	
6,0 x 140	12,0	70	70	4,79	1,73			2,07		2	2,84	
6,0 x 150	12,0	80	70	4,79	1,73			2,07		2	2,84	
6,0 x 160	12,0	90	70	4,79	1,73			2,07		2	2,84	
6,0 x 180	12,0	110	70	4,79	1,73			2,07		2	2,84	
6,0 x 200	12,0	130	70	4,79	1,73			2,07		2	2,84	
6,0 x 220	12,0	150	70	4,79	1,73			2,07		2	2,84	
6,0 x 240	12,0	170	70	4,79	1,73			2,07		2	2,84	
6,0 x 260	12,0	190	70	4,79	1,73			2,07		2	2,84	
6,0 x 280	12,0	210	70	4,79	1,73			2,07		2	2,84	
6,0 x 300	12,0	230	70	4,79	1,73			2,07		2	2,84	
8,0 x 80	14,5	30	50	4,26	2,52	3,71	2,90	3,71	2,90	3	4,56	3,94
8,0 x 100	14,5	40	60	5,33	2,52	4,13	3,30	4,13	3,30	3	4,83	4,20
8,0 x 120	14,5	50	70	5,86	2,52	4,13	3,50	4,13	3,50	3	4,96	4,34
8,0 x 140	14,5	40	100	8,44	2,52	4,13	3,30	4,13	3,30	3	5,60	4,98
8,0 x 160	14,5	60	100	8,44	2,52	4,13	3,50	4,13	3,50	3	5,60	4,98
8,0 x 180	14,5	80	100	8,44	2,52	4,13	3,50	4,13	3,50	3	5,60	4,98
8,0 x 200	14,5	100	100	8,44	2,52	4,13	3,50	3,50	4,13	3	5,60	4,98
8,0 x 220	14,5	120	100	8,44	2,52	4,13	3,50	3,50	4,13	3	5,60	4,98
8,0 x 240	14,5	140	100	8,44	2,52	4,13	3,50	3,50	4,13	3	5,60	4,98
8,0 x 260	14,5	160	100	8,44	2,52	4,13	3,50	3,50	4,13	3	5,60	4,98
8,0 x 280	14,5	180	100	8,44	2,52	4,13	3,50	3,50	4,13	3	5,60	4,98
8,0 x 300	14,5	200	100	8,44	2,52	4,13	3,50	3,50	4,13	3	5,60	4,98
8,0 x 320	14,5	220	100	8,44	2,52	4,13	3,50	3,50	4,13	3	5,60	4,98
8,0 x 340	14,5	240	100	8,44	2,52	4,13	3,50	3,50	4,13	3	5,60	4,98
8,0 x 360	14,5	260	100	8,44	2,52	4,13	3,50	3,50	4,13	3	5,60	4,98
8,0 x 380	14,5	280	100	8,44	2,52	4,13	3,50	3,50	4,13	3	5,60	4,98
8,0 x 400	14,5	300	100	8,44	2,52	4,13	3,50	3,50	4,13	3	5,60	4,98

Calculation according to ETA-11/0024. Wood density $\rho_k = 350 \text{ kg/m}^3$. All mechanical values provided should be viewed as subject to the assumptions that have been made and represent example calculations.

All values are calculated minimum values and are subject to typographical and printing errors.

a) The characteristic values of the load-bearing capacity R_k cannot be treated as equivalent to the max. possible load (the max. force). Characteristic values of the load-bearing capacity R_k should be reduced to dimensioning values R_d with regard to the usage class and class of the load duration: $R_d = R_k \cdot k_{mod} / \gamma_M$. The dimensioning values of the load-bearing capacity R_d should be contrasted with the dimensioning values of the loads ($R_d \geq E_d$).

Example:

Characteristic value for constant load (dead weight) $G_k = 2,00 \text{ kN}$ and variable load (e. g. snow load) $Q_k = 3,00 \text{ kN}$. $k_{mod} = 0,9$. $\gamma_M = 1,3$.

→ Dimensioning value of the load $E_d = 2,00 \cdot 1,35 + 3,00 \cdot 1,5 = 7,20 \text{ kN}$.

The load-bearing capacity of the joint is therefore considered to have been demonstrated if $R_d \geq E_d$. → $\min R_k = R_d \cdot \gamma_M / k_{mod}$

i.e. the characteristic minimum value is calculated based on: $\min R_k = R_d \cdot \gamma_M / k_{mod} \rightarrow R_k = 7,20 \text{ kN} \cdot 1,3 / 0,9 = 10,40 \text{ kN}$ → comparison with table values.

Please note: These are planning aids. Projects must only be calculated by authorised persons.

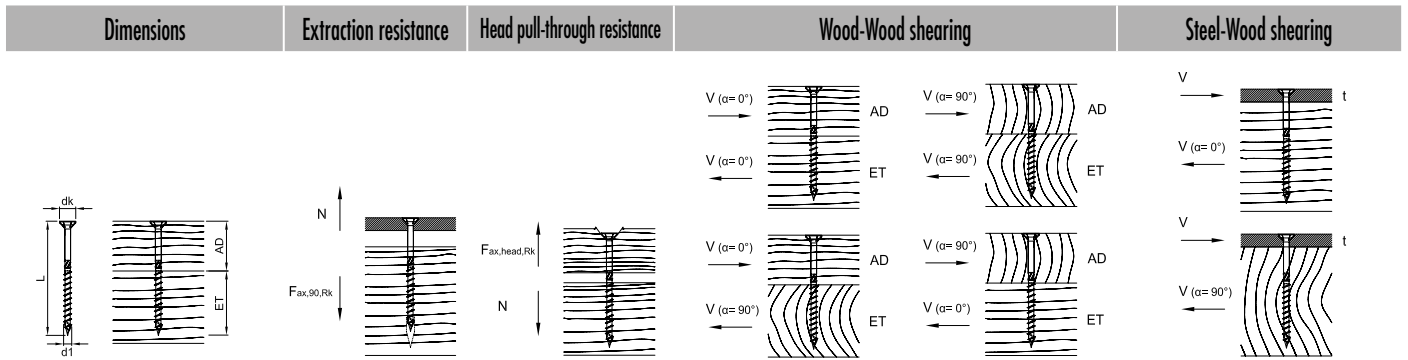

d1 x L [mm]	dk [mm]	AD [mm]	ET [mm]	F _{ax,90,Rk} [kN]	F _{ax,head,Rk} [kN]	F _{la,Rk} [kN]				t [mm]	F _{la,Rk} [kN]	
						alpha = 0°	alpha = 90°	alpha AD = 0°			alpha = 0°	alpha = 90°
								alpha ET = 90°	alpha ET = 0°			
8,0 x 420	14,5	300	100	8,44	2,52	4,13	3,50	3,50	4,13	3	5,60	4,98
8,0 x 440	14,5	300	100	8,44	2,52	4,13	3,50	3,50	4,13	3	5,60	4,98
8,0 x 460	14,5	300	100	8,44	2,52	4,13	3,50	3,50	4,13	3	5,60	4,98
8,0 x 480	14,5	300	100	8,44	2,52	4,13	3,50	3,50	4,13	3	5,60	4,98
8,0 x 500	14,5	300	100	8,44	2,52	4,13	3,50	3,50	4,13	3	5,60	4,98
8,0 x 550	14,5	300	100	8,44	2,52	4,13	3,50	3,50	4,13	3	5,60	4,98
8,0 x 600	14,5	300	100	8,44	2,52	4,13	3,50	3,50	4,13	3	5,60	4,98
10,0 x 100	17,8	40	60	6,48	3,63	5,73	4,37	5,73	4,37	3	6,78	5,81
10,0 x 120	17,8	50	70	7,13	3,63	6,07	4,87	6,07	4,87	3	6,94	5,97
10,0 x 140	17,8	40	100	10,26	3,63	5,73	4,37	5,73	4,37	3	7,72	6,76
10,0 x 160	17,8	60	100	10,26	3,63	6,07	5,10	6,07	5,10	3	7,72	6,76
10,0 x 180	17,8	80	100	10,26	3,63	6,07	5,10	6,07	5,10	3	7,72	6,76
10,0 x 200	17,8	100	100	10,26	3,63	6,07	5,10	5,10	6,07	3	7,72	6,76
10,0 x 220	17,8	120	100	10,26	3,63	6,07	5,10	5,10	6,07	3	7,72	6,76
10,0 x 240	17,8	140	100	10,26	3,63	6,07	5,10	5,10	6,07	3	7,72	6,76
10,0 x 260	17,8	160	100	10,26	3,63	6,07	5,10	5,10	6,07	3	7,72	6,76
10,0 x 280	17,8	180	100	10,26	3,63	6,07	5,10	5,10	6,07	3	7,72	6,76
10,0 x 300	17,8	200	100	10,26	3,63	6,07	5,10	5,10	6,07	3	7,72	6,76
10,0 x 320	17,8	220	100	10,26	3,63	6,07	5,10	5,10	6,07	3	7,72	6,76
10,0 x 340	17,8	240	100	10,26	3,63	6,07	5,10	5,10	6,07	3	7,72	6,76
10,0 x 360	17,8	260	100	10,26	3,63	6,07	5,10	5,10	6,07	3	7,72	6,76
10,0 x 380	17,8	280	100	10,26	3,63	6,07	5,10	5,10	6,07	3	7,72	6,76
10,0 x 400	17,8	300	100	10,26	3,63	6,07	5,10	5,10	6,07	3	7,72	6,76

Calculation according to ETA-11/0024. Wood density $\rho_k = 350 \text{ kg/m}^3$. All mechanical values provided should be viewed as subject to the assumptions that have been made and represent example calculations.

All values are calculated minimum values and are subject to typographical and printing errors.

a) The characteristic values of the load-bearing capacity R_k cannot be treated as equivalent to the max. possible load (the max. force). Characteristic values of the load-bearing capacity R_k should be reduced to dimensioning values R_d with regard to the usage class and class of the load duration: $R_d = R_k \cdot k_{mod} / \gamma_M$. The dimensioning values of the load-bearing capacity R_d should be contrasted with the dimensioning values of the loads ($R_d \geq E_d$).

Example:

Characteristic value for constant load (dead weight) $G_k = 2,00 \text{ kN}$ and variable load (e. g. snow load) $Q_k = 3,00 \text{ kN}$. $k_{mod} = 0,9$. $\gamma_M = 1,3$.

→ Dimensioning value of the load $E_d = 2,00 \cdot 1,35 + 3,00 \cdot 1,5 = 7,20 \text{ kN}$.

The load-bearing capacity of the joint is therefore considered to have been demonstrated if $R_d \geq E_d$. → $\min R_k = R_d \cdot \gamma_M / k_{mod}$

i.e. the characteristic minimum value is calculated based on: $\min R_k = R_d \cdot \gamma_M / k_{mod} \rightarrow R_k = 7,20 \text{ kN} \cdot 1,3 / 0,9 = 10,40 \text{ kN}$ → comparison with table values.

Please note: These are planning aids. Projects must only be calculated by authorised persons.

Please note: Verify the assumptions made. The stated values, and type and number of joining devices are based on preliminary measurements. Projects are to be dimensioned exclusively by authorised persons in accordance with the State Building Code. As per LBauO, please contact a qualified structural engineer for a paid proof of stability. We will be happy to refer you to someone.

Paneltwistec AG

Flanged button-head screw, blue galvanised



ADVANTAGES

- The larger head diameter allows for considerably higher torque and head pull-through capacity
- This makes for better use of the screw's tensile load-bearing strength

Art. no.	Dimensions [mm]	Drive	PU
946158	4,0 x 40	TX20 ●	500
946159	4,0 x 50	TX20 ●	500
946160	4,0 x 60	TX20 ●	500
946161	4,5 x 50	TX20 ●	200
946162	4,5 x 60	TX20 ●	200
946163	4,5 x 70	TX20 ●	200
946037	5,0 x 50	TX25 ●	200
946038	5,0 x 60	TX25 ●	200
946039	5,0 x 70	TX25 ●	200
946040	5,0 x 80	TX25 ●	200
946042	5,0 x 100	TX25 ●	200
945947	6,0 x 30	TX30 ●	100
945948	6,0 x 40	TX30 ●	100
945712	6,0 x 50	TX30 ●	100
945713	6,0 x 60	TX30 ●	100
945716	6,0 x 70	TX30 ●	100
945717	6,0 x 80	TX30 ●	100
945718	6,0 x 90	TX30 ●	100
945719	6,0 x 100	TX30 ●	100
945720	6,0 x 110	TX30 ●	100
945721	6,0 x 120	TX30 ●	100
945722	6,0 x 130	TX30 ●	100
945723	6,0 x 140	TX30 ●	100
945724	6,0 x 150	TX30 ●	100
945725	6,0 x 160	TX30 ●	100
945726	6,0 x 180	TX30 ●	100
945727	6,0 x 200	TX30 ●	100
945728	6,0 x 220	TX30 ●	100
945729	6,0 x 240	TX30 ●	100
945730	6,0 x 260	TX30 ●	100
945731	6,0 x 280	TX30 ●	100
945732	6,0 x 300	TX30 ●	100

Paneltwistec AG

Flanged button-head screw, blue galvanised



ADVANTAGES

- The larger head diameter allows for considerably higher torque and head pull-through capacity
- This makes for better use of the screw's tensile load-bearing strength

Art. no.	Dimensions [mm]	Drive	PU
945806	8,0 x 60	TX40 ●	50
944588	8,0 x 80	TX40 ●	50
944589	8,0 x 100	TX40 ●	50
944590	8,0 x 120	TX40 ●	50
944591	8,0 x 140	TX40 ●	50
944592	8,0 x 160	TX40 ●	50
944593	8,0 x 180	TX40 ●	50
944594	8,0 x 200	TX40 ●	50
944595	8,0 x 220	TX40 ●	50
944596	8,0 x 240	TX40 ●	50
944597	8,0 x 260	TX40 ●	50
944598	8,0 x 280	TX40 ●	50
944599	8,0 x 300	TX40 ●	50
944600	8,0 x 320	TX40 ●	50
944601	8,0 x 340	TX40 ●	50
944602	8,0 x 360	TX40 ●	50
944603	8,0 x 380	TX40 ●	50
944604	8,0 x 400	TX40 ●	50
944605	8,0 x 420	TX40 ●	25
944606	8,0 x 440	TX40 ●	25
944607	8,0 x 460	TX40 ●	25
944608	8,0 x 480	TX40 ●	25
944609	8,0 x 500	TX40 ●	25
944610	8,0 x 550	TX40 ●	25
944611	8,0 x 600	TX40 ●	25

Paneltwistec AG

Flanged button-head screw, blue galvanised



ADVANTAGES

- The larger head diameter allows for considerably higher torque and head pull-through capacity
- This makes for better use of the screw's tensile load-bearing strength

Art. no.	Dimensions [mm]	Drive	PU
945750	10 x 80	TX50 •	50
945751	10 x 100	TX50 •	50
945752	10 x 120	TX50 •	50
945753	10 x 140	TX50 •	50
945754	10 x 160	TX50 •	50
945755	10 x 180	TX50 •	50
945756	10 x 200	TX50 •	50
945757	10 x 220	TX50 •	50
945758	10 x 240	TX50 •	50
945759	10 x 260	TX50 •	50
945760	10 x 280	TX50 •	50
945761	10 x 300	TX50 •	50
945762	10 x 320	TX50 •	50
945763	10 x 340	TX50 •	50
945764	10 x 360	TX50 •	50
945765	10 x 380	TX50 •	50
945766	10 x 400	TX50 •	50



Paneltwistec flanged button-head used for the installation of a wall.

TECHNICAL INFORMATION PANELTWISTEC AG, FLANGE BUTTON HEAD, BLUE GALVANISED

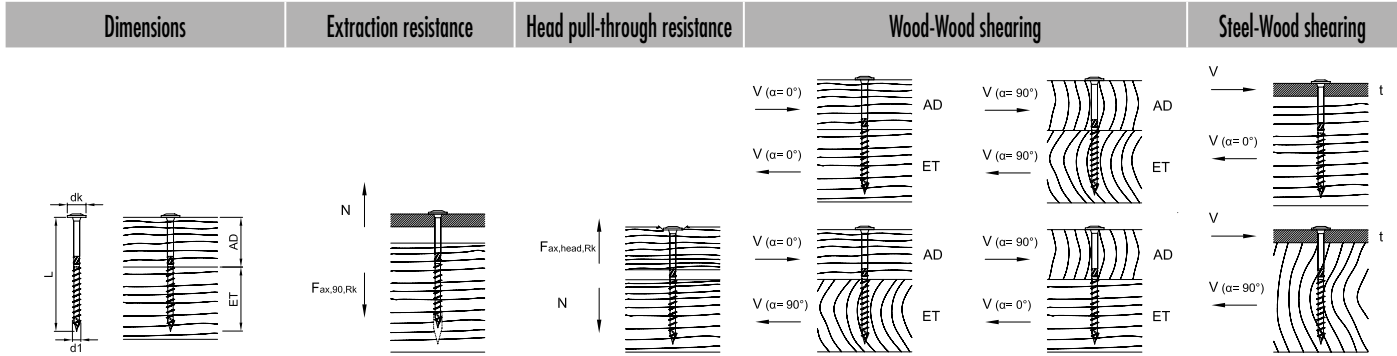

d1 x L [mm]	dk [mm]	AD [mm]	ET [mm]	F _{ax,90,Rk} [kN]	F _{ax,head,Rk} [kN]	F _{l0,Rk} [kN]				t [mm]	F _{l0,Rk} [kN]	
						α=0°	α=90°	α _{AD} =0° α _{ET} =90°	α _{AD} =90° α _{ET} =0°		α=0°	α=90°
4,0 x 40	10,0	16	24	1,24	1,20			0,95		2	1,15	
4,0 x 50	10,0	20	30	1,55	1,20			1,03		2	1,23	
4,0 x 60	10,0	24	36	1,86	1,20			1,12		2	1,31	
4,5 x 50	11,0	20	30	1,69	1,45			1,20		2	1,44	
4,5 x 60	11,0	24	36	2,03	1,45			1,29		2	1,53	
4,5 x 70	11,0	28	42	2,36	1,45			1,38		2	1,61	
5,0 x 50	12,0	20	30	1,82	1,73			1,37		2	1,67	
5,0 x 60	12,0	24	36	2,18	1,73			1,47		2	1,76	
5,0 x 70	12,0	28	42	2,54	1,73			1,57		2	1,85	
5,0 x 80	12,0	32	48	2,90	1,73			1,65		2	1,94	
5,0 x 100	12,0	40	60	3,63	1,73			1,65		2	2,12	
6,0 x 30	14,0	6	24	1,64	2,35			0,65		2	1,20	
6,0 x 40	14,0	16	24	1,64	2,35			1,33		2	1,63	
6,0 x 50	14,0	20	30	2,05	2,35			1,66		2	2,06	
6,0 x 60	14,0	24	36	2,46	2,35			1,87		2	2,26	
6,0 x 70	14,0	28	42	2,87	2,35			1,97		2	2,36	
6,0 x 80	14,0	32	48	3,28	2,35			2,09		2	2,46	
6,0 x 90	14,0	36	54	3,69	2,35			2,21		2	2,57	
6,0 x 100	14,0	40	60	4,10	2,35			2,23		2	2,67	
6,0 x 110	14,0	44	66	4,79	2,35			2,23		2	2,77	
6,0 x 120	14,0	50	70	4,79	2,35			2,23		2	2,84	
6,0 x 130	14,0	60	70	4,79	2,35			2,23		2	2,84	
6,0 x 140	14,0	70	70	4,79	2,35			2,23		2	2,84	
6,0 x 150	14,0	80	70	4,79	2,35			2,23		2	2,84	
6,0 x 160	14,0	90	70	4,79	2,35			2,23		2	2,84	
6,0 x 180	14,0	110	70	4,79	2,35			2,23		2	2,84	
6,0 x 200	14,0	130	70	4,79	2,35			2,23		2	2,84	
6,0 x 220	14,0	150	70	4,79	2,35			2,23		2	2,84	
6,0 x 240	14,0	170	70	4,79	2,35			2,23		2	2,84	
6,0 x 260	14,0	190	70	4,79	2,35			2,23		2	2,84	
6,0 x 280	14,0	210	70	4,79	2,35			2,23		2	2,84	
6,0 x 300	14,0	230	70	4,79	2,35			2,23		2	2,84	

Calculation according to ETA-11/0024. Wood density ρ_k= 350 kg/m³. All mechanical values provided should be viewed as subject to the assumptions that have been made and represent example calculations.

All values are calculated minimum values and are subject to typographical and printing errors.

a) The characteristic values of the load-bearing capacity R_k cannot be treated as equivalent to the max. possible load (the max. force). Characteristic values of the load-bearing capacity R_k should be reduced to dimensioning values R_d with regard to the usage class and class of the load duration: R_d= R_k · k_{mod} / γ_M. The dimensioning values of the load-bearing capacity R_d should be contrasted with the dimensioning values of the loads (R_d ≥ E_d).

Example:

Characteristic value for constant load (dead weight) G_k= 2,00 kN and variable load (e. g. snow load) Q_k= 3,00 kN. k_{mod}= 0,9. γ_M= 1,3.

→ Dimensioning value of the load E_d= 2,00 · 1,35 + 3,00 · 1,5= 7,20 kN.

The load-bearing capacity of the joint is therefore considered to have been demonstrated if R_d ≥ E_d. → min R_k= R_d · γ_M / k_{mod}

i.e. the characteristic minimum value is calculated based on: min R_k= R_d · γ_M / k_{mod} → R_k= 7,20 kN · 1,3/0,9= 10,40 kN → comparison with table values.

Please note: These are planning aids. Projects must only be calculated by authorised persons.

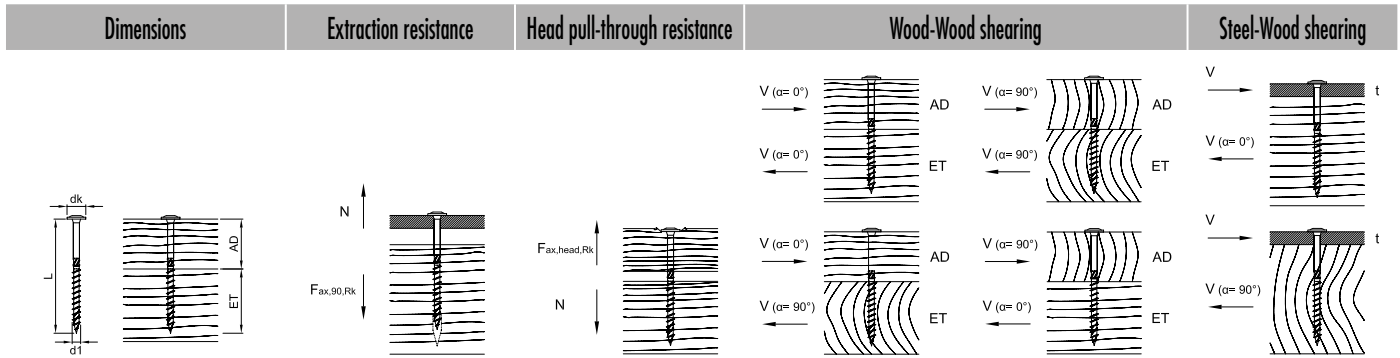

d1 x L [mm]	dk [mm]	AD [mm]	ET [mm]	Fax,90,Rk [kN]	Fax,head,Rk [kN]	F1a,Rk [kN]				t [mm]	F1a,Rk [kN]	
						alpha=0°	alpha=90°	alphaAD=0° alphaET=90°	alphaAD=90° alphaET=0°		alpha=0°	alpha=90°
8,0 x 80	22,0	30	50	4,26	5,81	4,14	3,34	4,14	3,34	3	4,56	3,94
8,0 x 100	22,0	40	60	5,33	5,81	4,83	4,01	4,83	4,01	3	4,83	4,20
8,0 x 120	22,0	50	70	5,86	5,81	4,95	4,32	4,95	4,32	3	4,96	4,34
8,0 x 140	22,0	40	100	8,44	5,81	4,95	4,13	4,95	4,13	3	5,60	4,98
8,0 x 160	22,0	60	100	8,44	5,81	4,95	4,32	4,95	4,32	3	5,60	4,98
8,0 x 180	22,0	80	100	8,44	5,81	4,95	4,32	4,95	4,32	3	5,60	4,98
8,0 x 200	22,0	100	100	8,44	5,81	4,95	4,32	4,32	4,95	3	5,60	4,98
8,0 x 220	22,0	120	100	8,44	5,81	4,95	4,32	4,32	4,95	3	5,60	4,98
8,0 x 240	22,0	140	100	8,44	5,81	4,95	4,32	4,32	4,95	3	5,60	4,98
8,0 x 260	22,0	160	100	8,44	5,81	4,95	4,32	4,32	4,95	3	5,60	4,98
8,0 x 280	22,0	180	100	8,44	5,81	4,95	4,32	4,32	4,95	3	5,60	4,98
8,0 x 300	22,0	200	100	8,44	5,81	4,95	4,32	4,32	4,95	3	5,60	4,98
8,0 x 320	22,0	220	100	8,44	5,81	4,95	4,32	4,32	4,95	3	5,60	4,98
8,0 x 340	22,0	240	100	8,44	5,81	4,95	4,32	4,32	4,95	3	5,60	4,98
8,0 x 360	22,0	260	100	8,44	5,81	4,95	4,32	4,32	4,95	3	5,60	4,98
8,0 x 380	22,0	280	100	8,44	5,81	4,95	4,32	4,32	4,95	3	5,60	4,98
8,0 x 400	22,0	300	100	8,44	5,81	4,95	4,32	4,32	4,95	3	5,60	4,98
8,0 x 420	22,0	300	100	8,44	5,81	4,95	4,32	4,32	4,95	3	5,60	4,98
8,0 x 440	22,0	300	100	8,44	5,81	4,95	4,32	4,32	4,95	3	5,60	4,98
8,0 x 460	22,0	300	100	8,44	5,81	4,95	4,32	4,32	4,95	3	5,60	4,98
8,0 x 480	22,0	300	100	8,44	5,81	4,95	4,32	4,32	4,95	3	5,60	4,98
8,0 x 500	22,0	300	100	8,44	5,81	4,95	4,32	4,32	4,95	3	5,60	4,98
8,0 x 550	22,0	300	100	8,44	5,81	4,95	4,32	4,32	4,95	3	5,60	4,98
8,0 x 600	22,0	300	100	8,44	5,81	4,95	4,32	4,32	4,95	3	5,60	4,98

Calculation according to ETA-11/0024. Wood density $\rho_k = 350 \text{ kg/m}^3$. All mechanical values provided should be viewed as subject to the assumptions that have been made and represent example calculations.

All values are calculated minimum values and are subject to typographical and printing errors.

a) The characteristic values of the load-bearing capacity R_k cannot be treated as equivalent to the max. possible load (the max. force). Characteristic values of the load-bearing capacity R_k should be reduced to dimensioning values R_d with regard to the usage class and class of the load duration: $R_d = R_k \cdot k_{mod} / \gamma_M$. The dimensioning values of the load-bearing capacity R_d should be contrasted with the dimensioning values of the loads ($R_d \geq E_d$).

Example:

Characteristic value for constant load (dead weight) $G_k = 2,00 \text{ kN}$ and variable load (e. g. snow load) $Q_k = 3,00 \text{ kN}$. $k_{mod} = 0,9$. $\gamma_M = 1,3$.

→ Dimensioning value of the load $E_d = 2,00 \cdot 1,35 + 3,00 \cdot 1,5 = 7,20 \text{ kN}$.

The load-bearing capacity of the joint is therefore considered to have been demonstrated if $R_d \geq E_d$. → $\min R_k = R_d \cdot \gamma_M / k_{mod}$

i.e. the characteristic minimum value is calculated based on: $\min R_k = R_d \cdot \gamma_M / k_{mod} \rightarrow R_k = 7,20 \text{ kN} \cdot 1,3 / 0,9 = 10,40 \text{ kN}$ → comparison with table values.

Please note: These are planning aids. Projects must only be calculated by authorised persons.

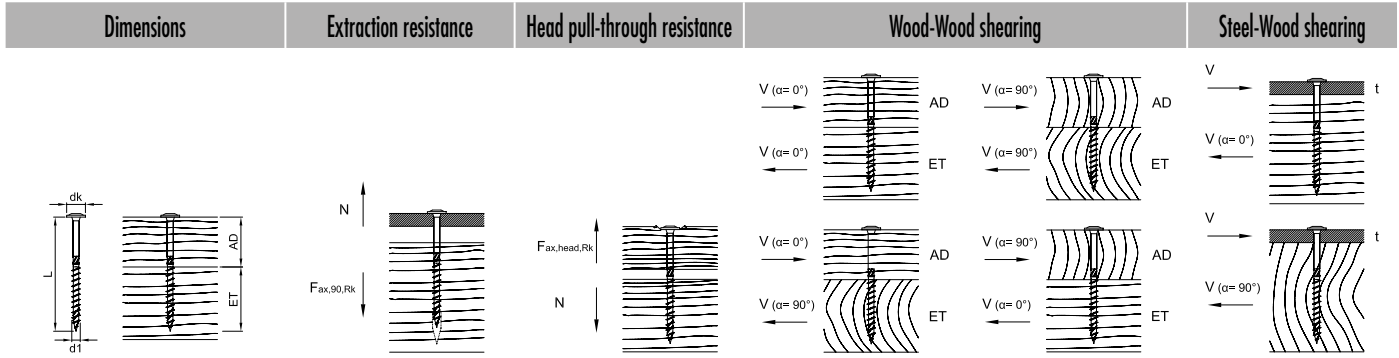

d1 x L [mm]	dk [mm]	AD [mm]	ET [mm]	Fax,90,Rk [kN]	Fax,head,Rk [kN]	F _{lα,Rk} [kN]		F _{lα,Rk} [kN]		t [mm]	F _{lα,Rk} [kN]	
						α=0°	α=90°	αAD=0°			α=0°	α=90°
								αET=90°	αET=0°			
10,0 x 100	25,0	40	60	6,48	7,50	6,44	5,08	6,44	5,08	3	6,78	5,81
10,0 x 120	25,0	50	70	7,13	7,50	6,94	5,74	6,94	5,74	3	6,94	5,97
10,0 x 140	25,0	40	100	10,26	7,50	6,70	5,34	6,70	5,34	3	7,72	6,76
10,0 x 160	25,0	60	100	10,26	7,50	7,03	6,07	7,03	6,07	3	7,72	6,76
10,0 x 180	25,0	80	100	10,26	7,50	7,03	6,07	7,03	6,07	3	7,72	6,76
10,0 x 200	25,0	100	100	10,26	7,50	7,03	6,07	6,07	7,03	3	7,72	6,76
10,0 x 220	25,0	120	100	10,26	7,50	7,03	6,07	6,07	7,03	3	7,72	6,76
10,0 x 240	25,0	140	100	10,26	7,50	7,03	6,07	6,07	7,03	3	7,72	6,76
10,0 x 260	25,0	160	100	10,26	7,50	7,03	6,07	6,07	7,03	3	7,72	6,76
10,0 x 280	25,0	180	100	10,26	7,50	7,03	6,07	6,07	7,03	3	7,72	6,76
10,0 x 300	25,0	200	100	10,26	7,50	7,03	6,07	6,07	7,03	3	7,72	6,76
10,0 x 320	25,0	220	100	10,26	7,50	7,03	6,07	6,07	7,03	3	7,72	6,76
10,0 x 340	25,0	240	100	10,26	7,50	7,03	6,07	6,07	7,03	3	7,72	6,76
10,0 x 360	25,0	260	100	10,26	7,50	7,03	6,07	6,07	7,03	3	7,72	6,76
10,0 x 380	25,0	280	100	10,26	7,50	7,03	6,07	6,07	7,03	3	7,72	6,76
10,0 x 400	25,0	300	100	10,26	7,50	7,03	6,07	6,07	7,03	3	7,72	6,76

Calculation according to ETA-11/0024. Wood density ρ_k= 350 kg/m³. All mechanical values provided should be viewed as subject to the assumptions that have been made and represent example calculations.

All values are calculated minimum values and are subject to typographical and printing errors.

a) The characteristic values of the load-bearing capacity R_k cannot be treated as equivalent to the max. possible load (the max. force). Characteristic values of the load-bearing capacity R_k should be reduced to dimensioning values R_d with regard to the usage class and class of the load duration: R_d= R_k · k_{mod} / γ_M. The dimensioning values of the load-bearing capacity R_d should be contrasted with the dimensioning values of the loads (R_d ≥ E_d).

Example:

Characteristic value for constant load (dead weight) G_k= 2,00 kN and variable load (e. g. snow load) Q_k= 3,00 kN. k_{mod}= 0,9. γ_M= 1,3.

→ Dimensioning value of the load E_d= 2,00 · 1,35 + 3,00 · 1,5= 7,20 kN.

The load-bearing capacity of the joint is therefore considered to have been demonstrated if R_d ≥ E_d. → min R_k= R_d · γ_M / k_{mod}

i.e. the characteristic minimum value is calculated based on: min R_k= R_d · γ_M / k_{mod} → R_k= 7,20 kN · 1,3/0,9= 10,40 kN → comparison with table values.

Please note: These are planning aids. Projects must only be calculated by authorised persons.

PANELTWISTEC, PANELTWISTEC AG

HARDENED STAINLESS STEEL



Paneltwistec

Countersunk-head, hardened stainless steel



ADVANTAGES

- Limited resistance to acid
- Not suitable for use with woods containing tanning agents such as cumarú, oak, merbau, robinia, etc.
- Magnetised
- Stainless steel in accordance with DIN 10088
- The screw is suitable for use in timber-timber joints in outdoor installations and is used in garden, façade and balcony construction

Art. no.	Dimensions [mm]	Drive	PU
904474	4,0 x 40	TX20 ●	500
904475	4,0 x 45	TX20 ●	500
904476	4,0 x 50	TX20 ●	500
904477	4,0 x 60	TX20 ●	500
904478	4,5 x 45	TX20 ●	200
904479	4,5 x 50	TX20 ●	200
904480	4,5 x 60	TX20 ●	200
904481	4,5 x 70	TX20 ●	200
100981	4,5 x 80	TX20 ●	200
904482	5,0 x 50	TX25 ●	200
904483	5,0 x 60	TX25 ●	200
904484	5,0 x 70	TX25 ●	200
904485	5,0 x 80	TX25 ●	200
904487	5,0 x 90	TX25 ●	100
904011	5,0 x 100	TX25 ●	100
904012	6,0 x 60	TX30 ●	100
904013	6,0 x 70	TX30 ●	100
904014	6,0 x 80	TX30 ●	100
904015	6,0 x 90	TX30 ●	100
904016	6,0 x 100	TX30 ●	100
904017	6,0 x 120	TX30 ●	100
904018	6,0 x 140	TX30 ●	100
904019	6,0 x 160	TX30 ●	100

Paneltwistec

Flanged button-head, hardened stainless steel



ADVANTAGES

- Also suitable for fastening over-rafter insulation
- The larger head diameter allows for considerably higher torque and head pull-through capacity
- This makes for better use of the screw's tensile load-bearing strength

Art. no.	Dimensions [mm]	Drive	PU
945278	8,0 x 80	TX40 ●	50
945270	8,0 x 100	TX40 ●	50
945271	8,0 x 120	TX40 ●	50
945272	8,0 x 140	TX40 ●	50
945364	8,0 x 160	TX40 ●	50
945365	8,0 x 180	TX40 ●	50
945366	8,0 x 200	TX40 ●	50
945367	8,0 x 220	TX40 ●	50
945368	8,0 x 240	TX40 ●	50
945369	8,0 x 260	TX40 ●	50
945370	8,0 x 280	TX40 ●	50
945371	8,0 x 300	TX40 ●	50
945372	8,0 x 320	TX40 ●	50
945373	8,0 x 340	TX40 ●	50
945374	8,0 x 360	TX40 ●	50
945375	8,0 x 380	TX40 ●	50
945376	8,0 x 400	TX40 ●	50

Paneltwistec AG

Flanged button-head, hardened stainless steel



Art. no.	Dimensions [mm]	Drive	PU
975772	6,0 x 60	TX30 ●	100
975773	6,0 x 80	TX30 ●	100
975774	6,0 x 100	TX30 ●	100
975775	6,0 x 120	TX30 ●	100
975776	6,0 x 140	TX30 ●	100
975777	6,0 x 160	TX30 ●	100

Paneltwistec A2

Countersunk head, Stainless steel A2



ADVANTAGES

- Limited resistance to acid
- Not suitable for atmospheres containing chlorine

Art. no.	Dimensions [mm]	Drive	PU
903230	8,0 x 80	TX40 ●	50
903231	8,0 x 100	TX40 ●	50
903232	8,0 x 120	TX40 ●	50
903233	8,0 x 140	TX40 ●	50
903234	8,0 x 160	TX40 ●	50
903235	8,0 x 180	TX40 ●	50
903236	8,0 x 200	TX40 ●	50
903237	8,0 x 220	TX40 ●	50
903238	8,0 x 240	TX40 ●	50
903239	8,0 x 260	TX40 ●	50
903240	8,0 x 280	TX40 ●	50
903241	8,0 x 300	TX40 ●	50
903242	8,0 x 320	TX40 ●	50
903243	8,0 x 340	TX40 ●	50
903244	8,0 x 360	TX40 ●	50
903245	8,0 x 380	TX40 ●	50
903246	8,0 x 400	TX40 ●	50

Paneltwistec A2

Flanged button-head, Stainless steel



ADVANTAGES

- Limited resistance to acid
- Not suitable for atmospheres containing chlorine

Art. no.	Dimensions [mm]	Drive	PU
903211	8,0 x 80	TX40 ●	50
903212	8,0 x 100	TX40 ●	50
903213	8,0 x 120	TX40 ●	50
903214	8,0 x 140	TX40 ●	50
903215	8,0 x 160	TX40 ●	50
903216	8,0 x 180	TX40 ●	50
903217	8,0 x 200	TX40 ●	50
903218	8,0 x 220	TX40 ●	50
903219	8,0 x 240	TX40 ●	50
903220	8,0 x 260	TX40 ●	50
903221	8,0 x 280	TX40 ●	50
903222	8,0 x 300	TX40 ●	50
903223	8,0 x 320	TX40 ●	50
903224	8,0 x 340	TX40 ●	50
903225	8,0 x 360	TX40 ●	50
903226	8,0 x 380	TX40 ●	50
903227	8,0 x 400	TX40 ●	50

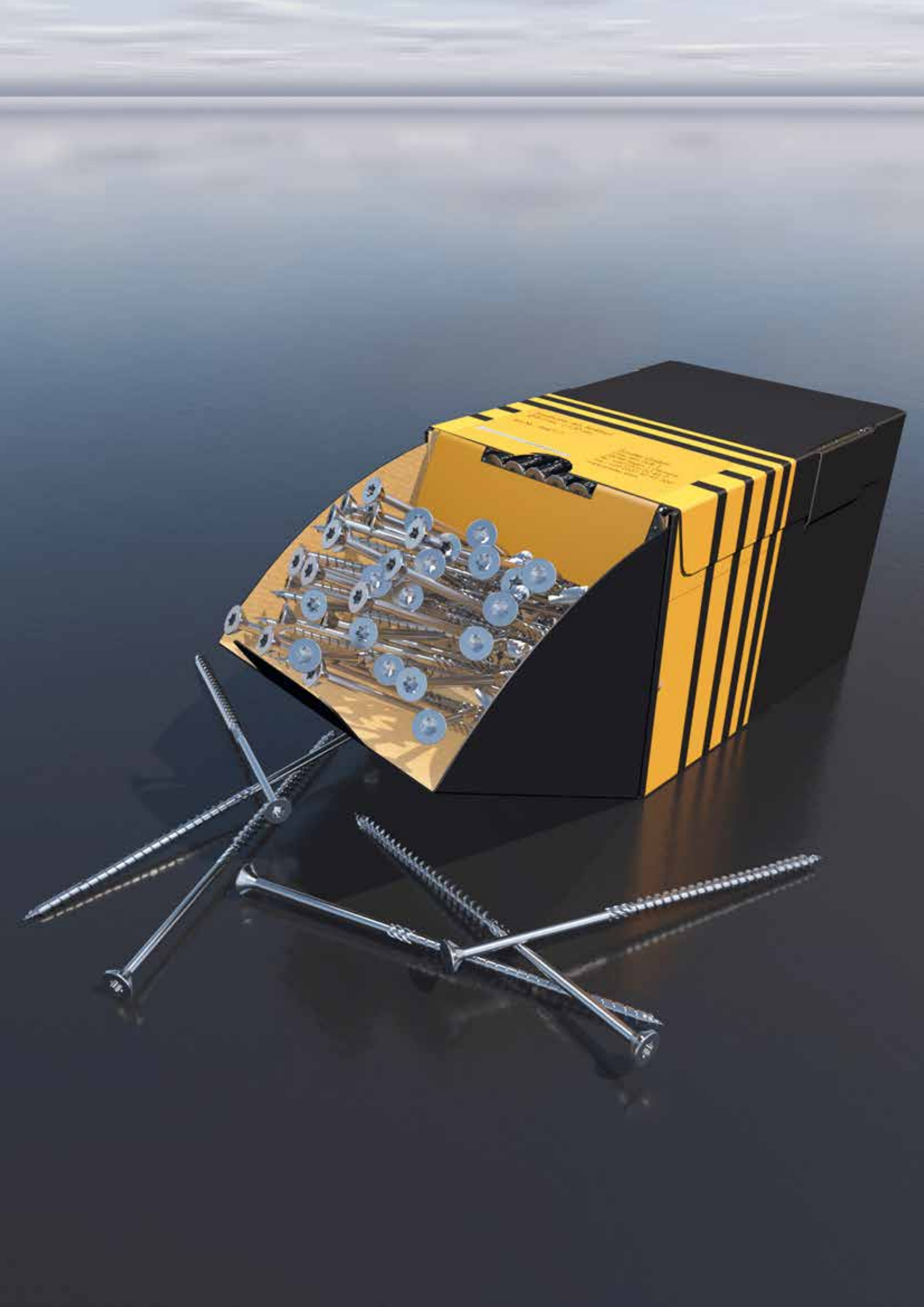

SAWTEC

WOOD CONSTRUCTION SCREW MADE OF HARDENED CARBON STEEL



ADVANTAGES OF THE SCREW HEAD

- Saw teeth under the head reduce chip placement
- No hammering of the screws when screwing in due to TX-Drive
- Low splitting effect
- Better "bite" of the screw

ADVANTAGES FRICTION PART

- Friction part creates space for the shank, thereby reduces the insertion resistance

ADVANTAGES THREAD

- The coarse thread is equipped with sharply rolled flanks to the tip
- Enables fast screwing-in

ADVANTAGES DAG TIP

- The special geometry of the DAG screw tip ensures a reduction of the screwing torque and also leads to a lower splitting effect when screwing-in

DESCRIPTION

The SawTec is a wood construction screw with a special screw tip and saw teeth below the head. The screw has a double-stage cylinder head. The special geometry of the screw tip reduces the screwing torque and also leads to a lower splitting effect when screwing in.

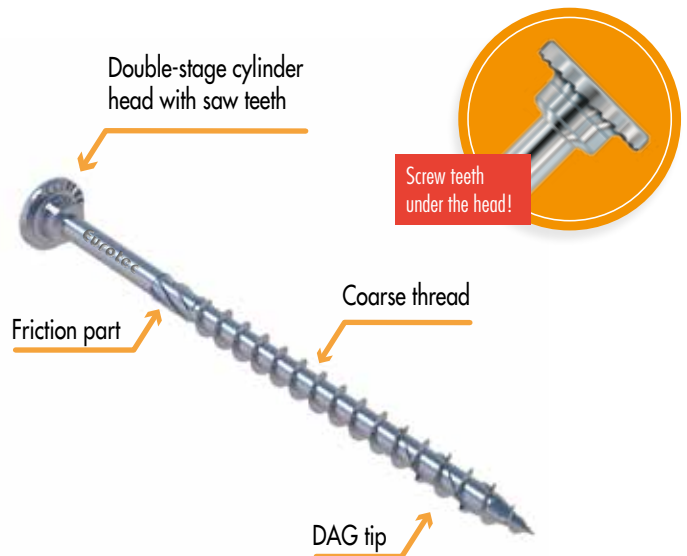

SawTec cylinder head blue Ø 8,0 x 160 mm

SawTec

Cylinder head, Steel blue galvanised



Art. no.	Dimensions [mm]	Drive	PU
954115	5,0 x 40	TX25 ●	200
954117	5,0 x 50	TX25 ●	200
954118	5,0 x 60	TX25 ●	200
954119	5,0 x 70	TX25 ●	200
954120	5,0 x 80	TX25 ●	200
954121	5,0 x 90	TX25 ●	200
954122	5,0 x 100	TX25 ●	200
954124	5,0 x 120	TX25 ●	200
954128	6,0 x 60	TX30 ●	100
954129	6,0 x 70	TX30 ●	100
954130	6,0 x 80	TX30 ●	100
954131	6,0 x 100	TX30 ●	100
954133	6,0 x 120	TX30 ●	100
954135	6,0 x 140	TX30 ●	100
954137	6,0 x 160	TX30 ●	100
954138	6,0 x 180	TX30 ●	100
954145	8,0 x 80	TX40 ●	50
954146	8,0 x 100	TX40 ●	50
954147	8,0 x 120	TX40 ●	50
954148	8,0 x 140	TX40 ●	50
954149	8,0 x 160	TX40 ●	50
954150	8,0 x 180	TX40 ●	50
954151	8,0 x 200	TX40 ●	50
954152	8,0 x 220	TX40 ●	50
954153	8,0 x 240	TX40 ●	50
954154	8,0 x 260	TX40 ●	50
954155	8,0 x 280	TX40 ●	50
954156	8,0 x 300	TX40 ●	50
954157	8,0 x 320	TX40 ●	50
954158	8,0 x 340	TX40 ●	50
954159	8,0 x 360	TX40 ●	50
954160	8,0 x 380	TX40 ●	50
954161	8,0 x 400	TX40 ●	50
954162	10,0 x 100	TX50 ●	50
954163	10,0 x 120	TX50 ●	50
954164	10,0 x 140	TX50 ●	50
954165	10,0 x 160	TX50 ●	50
954166	10,0 x 180	TX50 ●	50
954167	10,0 x 200	TX50 ●	50
954168	10,0 x 220	TX50 ●	50
954169	10,0 x 240	TX50 ●	50
954170	10,0 x 260	TX50 ●	50
954171	10,0 x 280	TX50 ●	50
954172	10,0 x 300	TX50 ●	50
954173	10,0 x 320	TX50 ●	50
954174	10,0 x 340	TX50 ●	50
954175	10,0 x 360	TX50 ●	25
954176	10,0 x 380	TX50 ●	25
954177	10,0 x 400	TX50 ●	25

TECHNICAL INFORMATION SAWTEC, CYLINDER HEAD, BLUE GALVANISED



Dimensions		Extraction resistance	Head pull-through resistance	Wood-Wood shearing				Steel-Wood shearing				
d1 x L [mm]	dk [mm]	AD [mm]	ET [mm]	F _{ax,90,Rk} [kN]	F _{ax,head,Rk} [kN]	F _{1a,Rk} [kN]	F _{1a,Rk} [kN]	F _{1a,Rk} [kN]	F _{1a,Rk} [kN]	t [mm]	F _{1a,Rk} [kN]	F _{1a,Rk} [kN]
						$\alpha=0^\circ$	$\alpha=90^\circ$	$\alpha_{AD}=0^\circ$	$\alpha_{AD}=90^\circ$		$\alpha=0^\circ$	$\alpha=90^\circ$
								$\alpha_{ET}=90^\circ$	$\alpha_{ET}=0^\circ$			
5,0 x 40	10,5	16	24	1,45	1,10			1,09		2	1,44	
5,0 x 50	10,5	20	30	1,82	1,10			1,22		2	1,67	
5,0 x 60	10,5	24	36	2,18	1,10			1,31		2	1,76	
5,0 x 70	10,5	28	42	2,54	1,10			1,41		2	1,85	
5,0 x 80	10,5	32	48	2,90	1,10			1,49		2	1,94	
5,0 x 90	10,5	36	54	3,27	1,10			1,49		2	2,03	
5,0 x 100	10,5	40	60	3,63	1,10			1,49		2	2,12	
5,0 x 120	10,5	60	60	3,63	1,10			1,49		2	2,12	
6,0 x 60	13,0	24	36	2,46	1,69			1,70		2	2,26	
6,0 x 70	13,0	28	42	2,87	1,69			1,81		2	2,36	
6,0 x 80	13,0	32	48	3,28	1,69			1,92		2	2,46	
6,0 x 90	13,0	36	54	3,69	1,69			2,04		2	2,57	
6,0 x 100	13,0	40	60	4,10	1,69			2,07		2	2,67	
6,0 x 110	13,0	50	60	4,10	1,69			2,07		2	2,67	
6,0 x 120	13,0	60	60	4,10	1,69			2,07		2	2,67	
6,0 x 130	13,0	60	70	4,79	1,69			2,07		2	2,84	
6,0 x 140	13,0	70	70	4,79	1,69			2,07		2	2,84	
6,0 x 150	13,0	80	70	4,79	1,69			2,07		2	2,84	
6,0 x 160	13,0	90	70	4,79	1,69			2,07		2	2,84	
6,0 x 180	13,0	110	70	4,79	1,69			2,07		2	2,84	

Calculation according to ETA-11/0024. Wood density $\rho_k = 350 \text{ kg/m}^3$. All mechanical values provided should be viewed as subject to the assumptions that have been made and represent example calculations.

All values are calculated minimum values and are subject to typographical and printing errors.

a) The characteristic values of the load-bearing capacity R_k cannot be treated as equivalent to the max. possible load (the max. force). Characteristic values of the load-bearing capacity R_k should be reduced to dimensioning values R_d with regard to the usage class and class of the load duration: $R_d = R_k \cdot k_{mod} / \gamma_M$. The dimensioning values of the load-bearing capacity R_d should be contrasted with the dimensioning values of the loads ($R_d \geq E_d$).

Example:

Characteristic value for constant load (dead weight) $G_k = 2,00 \text{ kN}$ and variable load (e. g. snow load) $Q_k = 3,00 \text{ kN}$. $k_{mod} = 0,9$. $\gamma_M = 1,3$.

→ Dimensioning value of the load $E_d = 2,00 \cdot 1,35 + 3,00 \cdot 1,5 = 7,20 \text{ kN}$.

The load-bearing capacity of the joint is therefore considered to have been demonstrated if $R_d \geq E_d$. → $\min R_k = R_d \cdot \gamma_M / k_{mod}$

i.e. the characteristic minimum value is calculated based on: $\min R_k = R_d \cdot \gamma_M / k_{mod} \rightarrow R_k = 7,20 \text{ kN} \cdot 1,3 / 0,9 = 10,40 \text{ kN}$ → comparison with table values.

Please note: These are planning aids. Projects must only be calculated by authorised persons.

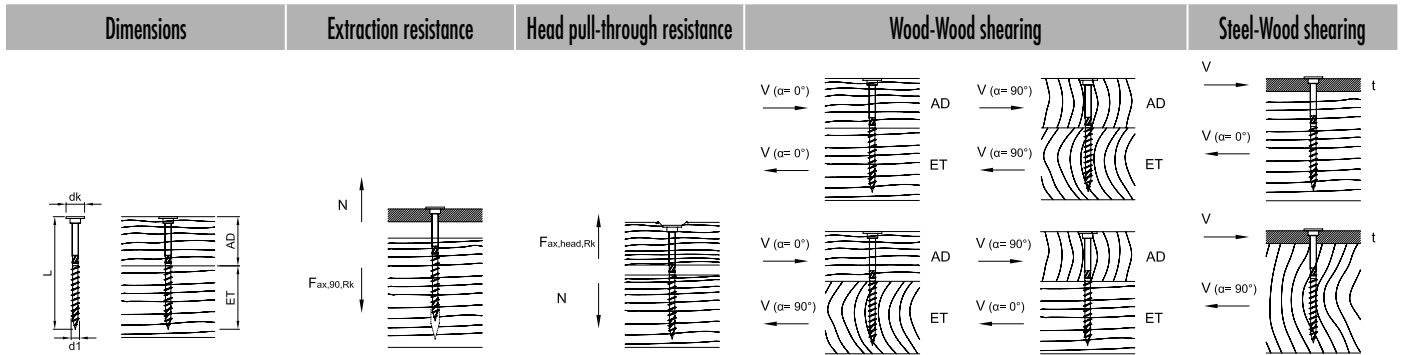

d1 x L [mm]	dk [mm]	AD [mm]	ET [mm]	F _{ax,90,Rk} [kN]	F _{ax,head,Rk} [kN]	F _{la,Rk} [kN]				t [mm]	F _{la,Rk} [kN]	
						α=0°	α=90°	α _{AD} =0° α _{ET} =90°	α _{AD} =90° α _{ET} =0°		α=0°	α=90°
8,0 x 80	18,0	30	50	4,26	3,24	3,89	3,08	3,89	3,08	3	4,61	3,94
8,0 x 100	18,0	40	60	5,33	3,24	4,31	3,48	4,31	3,48	3	4,83	4,20
8,0 x 120	18,0	60	60	5,33	3,24	4,31	3,68	4,31	3,68	3	4,83	4,20
8,0 x 140	18,0	40	100	8,44	3,24	4,31	3,48	4,31	3,48	3	5,60	4,98
8,0 x 160	18,0	60	100	8,44	3,24	4,31	3,68	4,31	3,68	3	5,60	4,98
8,0 x 180	18,0	80	100	8,44	3,24	4,31	3,68	4,31	3,68	3	5,60	4,98
8,0 x 200	18,0	100	100	8,44	3,24	4,31	3,68	3,68	4,31	3	5,60	4,98
8,0 x 220	18,0	120	100	8,44	3,24	4,31	3,68	3,68	4,31	3	5,60	4,98
8,0 x 240	18,0	140	100	8,44	3,24	4,31	3,68	3,68	4,31	3	5,60	4,98
8,0 x 260	18,0	160	100	8,44	3,24	4,31	3,68	3,68	4,31	3	5,60	4,98
8,0 x 280	18,0	180	100	8,44	3,24	4,31	3,68	3,68	4,31	3	5,60	4,98
8,0 x 300	18,0	200	100	8,44	3,24	4,31	3,68	3,68	4,31	3	5,60	4,98
8,0 x 320	18,0	220	100	8,44	3,24	4,31	3,68	3,68	4,31	3	5,60	4,98
8,0 x 340	18,0	240	100	8,44	3,24	4,31	3,68	3,68	4,31	3	5,60	4,98
8,0 x 360	18,0	260	100	8,44	3,24	4,31	3,68	3,68	4,31	3	5,60	4,98
8,0 x 380	18,0	280	100	8,44	3,24	4,31	3,68	3,68	4,31	3	5,60	4,98
8,0 x 400	18,0	300	100	8,44	3,24	4,31	3,68	3,68	4,31	3	5,60	4,98
8,0 x 420	18,0	320	100	8,44	3,24	4,31	3,68	3,68	4,31	3	5,60	4,98
8,0 x 440	18,0	340	100	8,44	3,24	4,31	3,68	3,68	4,31	3	5,60	4,98
8,0 x 460	18,0	360	100	8,44	3,24	4,31	3,68	3,68	4,31	3	5,60	4,98
8,0 x 480	18,0	380	100	8,44	3,24	4,31	3,68	3,68	4,31	3	5,60	4,98
8,0 x 500	18,0	400	100	8,44	3,24	4,31	3,68	3,68	4,31	3	5,60	4,98
8,0 x 550	18,0	450	100	8,44	3,24	4,31	3,68	3,68	4,31	3	5,60	4,98
8,0 x 600	18,0	500	100	8,44	3,24	4,31	3,68	3,68	4,31	3	5,60	4,98

Calculation according to ETA-11/0024. Wood density $\rho_k = 350 \text{ kg/m}^3$. All mechanical values provided should be viewed as subject to the assumptions that have been made and represent example calculations.

All values are calculated minimum values and are subject to typographical and printing errors.

a) The characteristic values of the load-bearing capacity R_k cannot be treated as equivalent to the max. possible load (the max. force). Characteristic values of the load-bearing capacity R_k should be reduced to dimensioning values R_d with regard to the usage class and class of the load duration: $R_d = R_k \cdot k_{mod} / \gamma_M$. The dimensioning values of the load-bearing capacity R_d should be contrasted with the dimensioning values of the loads ($R_d \geq E_d$).

Example:

Characteristic value for constant load (dead weight) $G_k = 2,00 \text{ kN}$ and variable load (e. g. snow load) $Q_k = 3,00 \text{ kN}$. $k_{mod} = 0,9$. $\gamma_M = 1,3$.

→ Dimensioning value of the load $E_d = 2,00 \cdot 1,35 + 3,00 \cdot 1,5 = 7,20 \text{ kN}$.

The load-bearing capacity of the joint is therefore considered to have been demonstrated if $R_d \geq E_d$. → $\min R_k = R_d \cdot \gamma_M / k_{mod}$

i.e. the characteristic minimum value is calculated based on: $\min R_k = R_d \cdot \gamma_M / k_{mod} \rightarrow R_k = 7,20 \text{ kN} \cdot 1,3 / 0,9 = 10,40 \text{ kN}$ → comparison with table values.

Please note: These are planning aids. Projects must only be calculated by authorised persons.

TOPDUO ROOFING SCREW

THE WOOD-CONSTRUCTION SCREW FOR ALL OVER-RAFTER INSULATION SYSTEMS



ADVANTAGES

- Double thread allows the fastening of compression-resistant and non-compression-resistant insulation materials
- Due to the high pull-out resistance, the screw is universally suitable for many applications in timber construction
- Resistant to mechanical stress
- No hammering of the screws when screwing-in due to TX-Drive

ADVANTAGES OF THE SCREW TIP

- Reduced screwing torque
- Reduced splitting effect
- Screws have a better "bite"



DESCRIPTION

The Topduo roofing screw can be used to fasten both compression-resistant and non-compression-resistant above-rafter insulation. The high pull-out resistance in both connecting timbers also makes the TopDuo roofing screw suitable for many other applications in timber construction. The screw has a double thread and is available with a flanged buttonhead and cylinder head.



Topduo flanged-button head for fastening insulation material.

Topduo roofing screw

Flanged button-head, special coated



ADVANTAGES / PROPERTIES

- Can also be used for many other applications in timber-frame construction thanks to its high extraction resistance

Art. no.	Dimensions [mm]	Length [mm] ^{a)}	Drive	PU
945870	8,0 x 165	60/80	TX40 ●	50
945871	8,0 x 195	60/100	TX40 ●	50
945813	8,0 x 225	60/100	TX40 ●	50
945814	8,0 x 235	60/100	TX40 ●	50
945815	8,0 x 255	60/100	TX40 ●	50
945816	8,0 x 275	60/100	TX40 ●	50
945817	8,0 x 302	60/100	TX40 ●	50
945818	8,0 x 335	60/100	TX40 ●	50
945819	8,0 x 365	60/100	TX40 ●	50
945820	8,0 x 397	60/100	TX40 ●	50
945821	8,0 x 435	60/100	TX40 ●	50
945843	8,0 x 472	60/100	TX40 ●	50

a) Under-head thread/drive thread

Topduo roofing screw

Cylinder head, special coated



ADVANTAGES / PROPERTIES

- Can also be used for many other applications in timber-frame construction thanks to its high extraction resistance

Art. no.	Dimensions [mm]	Length [mm] ^{a)}	Drive	PU
945956	8,0 x 225	60/100	TX40 ●	50
945965	8,0 x 235	60/100	TX40 ●	50
945957	8,0 x 255	60/100	TX40 ●	50
945958	8,0 x 275	60/100	TX40 ●	50
945960	8,0 x 302	60/100	TX40 ●	50
945961	8,0 x 335	60/100	TX40 ●	50
945962	8,0 x 365	60/100	TX40 ●	50
945963	8,0 x 397	60/100	TX40 ●	50
945964	8,0 x 435	60/100	TX40 ●	50

a) Under-head thread/drive thread

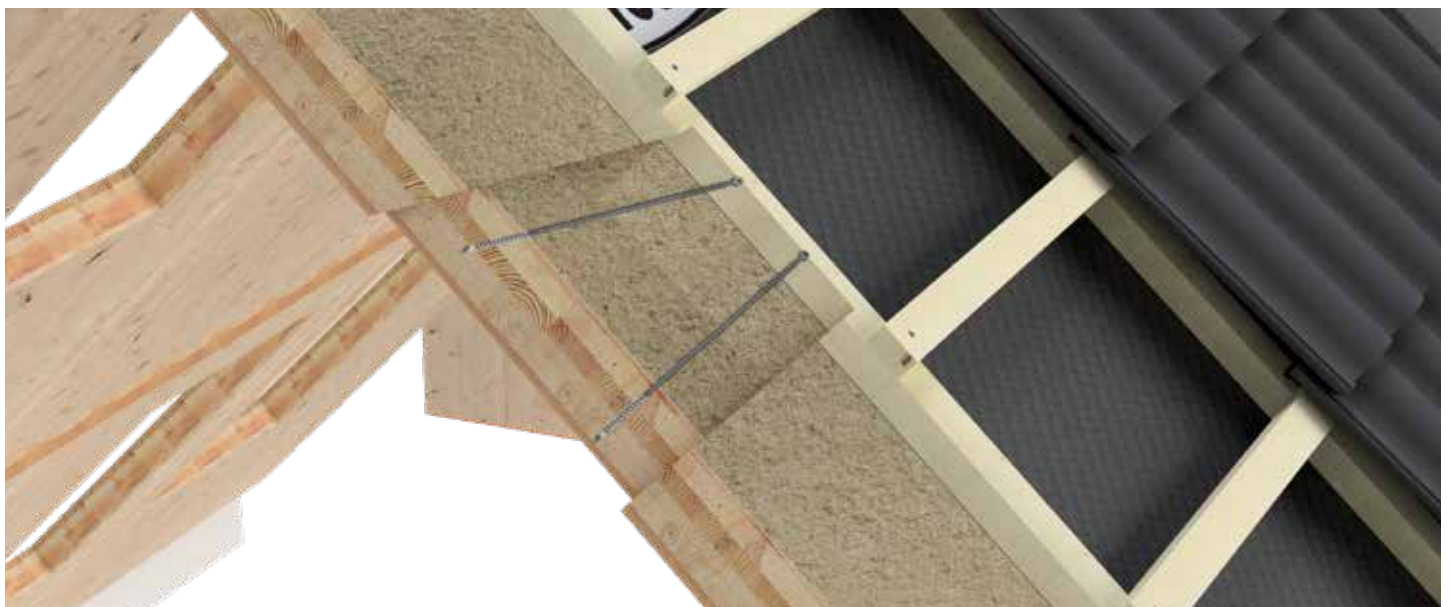

Topduo cylinder head screw for fastening insulation material.

Solely 90° screw connection
(absorption of wind suction)



Combined 65° and 90° screw connection
(absorption of shearing forces and wind suction)



Topduo roofing screw is suitable for pressure resistant (≥ 50 kPa) and non-pressure resistant insulations.
The compressive strength $\sigma_{10\%}$ can be found in the product data sheet issued by the insulating material manufacturer.

Fastening options



65° screw connection

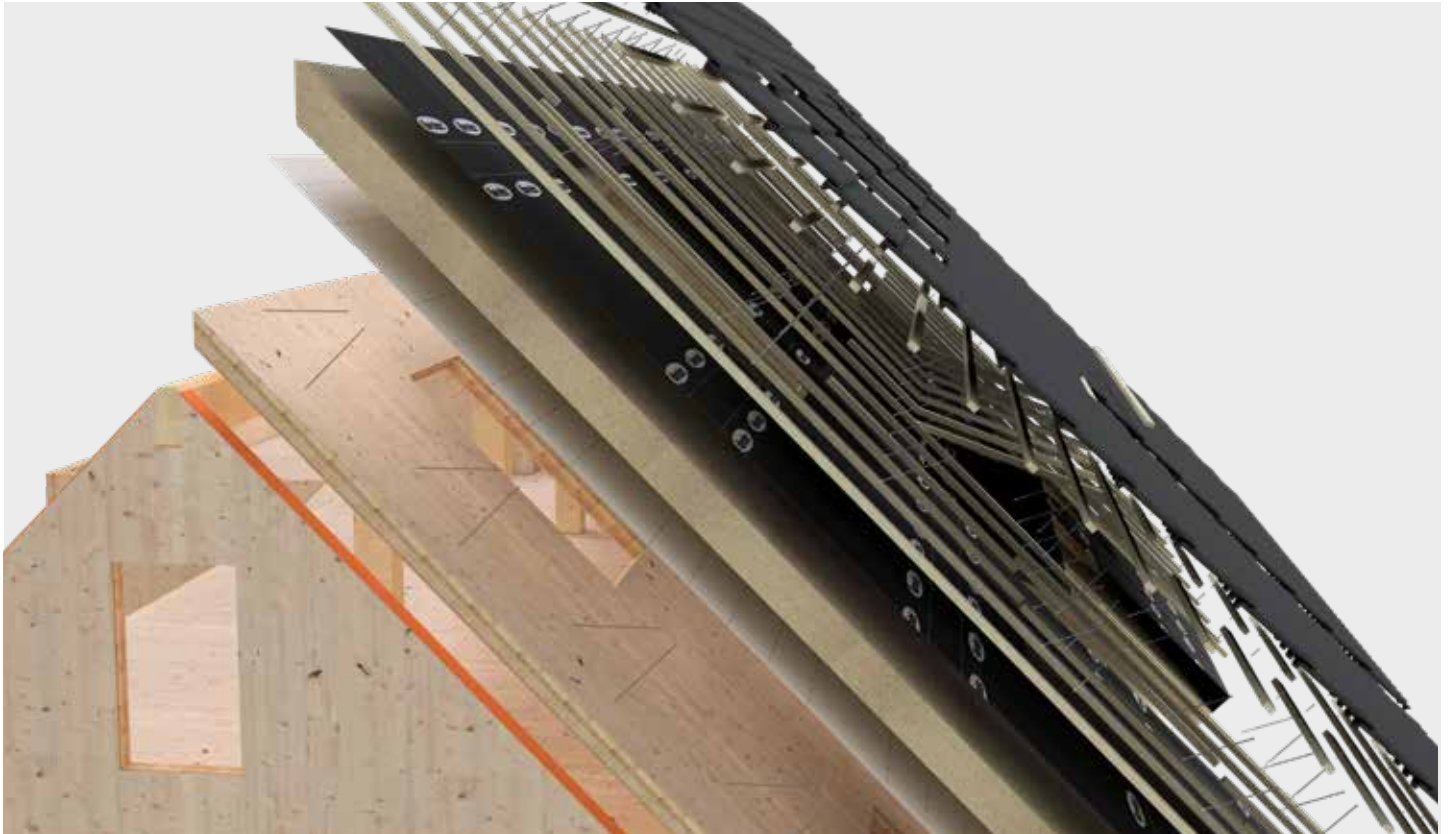

Roof construction with Topduo.

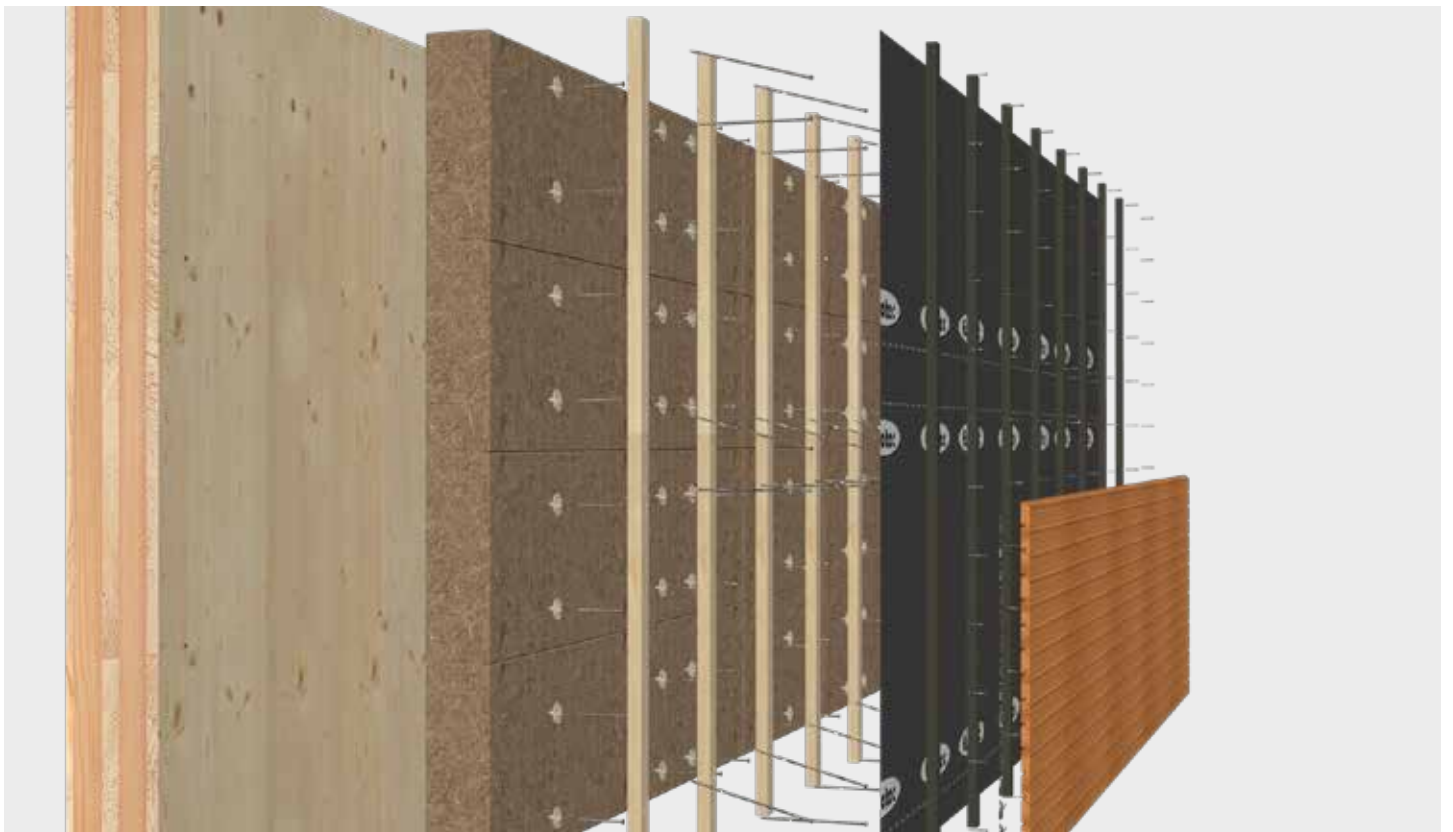

Façade construction with the Topduo roofing screw.

CALCULATING QUANTITIES FOR TOPDUO ROOFING SCREW STATICALLY NON-PRESSURE-RESISTANT INSULATING MATERIALS AT $\sigma_{10} \% < 50$ KPA

Design sample for specified assumptions, project-related design may yield significantly more favourable results

Number of Topduo screws per m²

Insulation thickness		40	60	80	100	120	140	140	160	180	200	220	240	260	280
Boarding thickness (on rafters)		24	24	24	24	24	–	24	24	24	24	24	24	24	24
Dimensions Topduo Flanged button-head acc. Cylinder-head ^{a)}		8 x 165 ^{b)}	8 x 195 ^{b)}	8 x 225	8 x 235	8 x 255	8 x 275	8 x 302	8 x 335	8 x 335	8 x 365	8 x 365	8 x 397	8 x 435	8 x 435
		[mm]	[mm]	[mm]	[mm]	[mm]	[mm]	[mm]	[mm]	[mm]	[mm]	[mm]	[mm]	[mm]	[mm]
Snow load zone 2 ^{c)} Wind zone 4 ^{d)} Altitude NN ≤ 285 m	0° < DN ≤ 10°	2,20	2,20	2,38	2,38	2,38	2,38	2,38	2,29	2,29	2,48	3,01	3,57	4,08	4,76
	10° < DN ≤ 25°	2,38	2,38	2,60	2,60	2,60	2,60	2,60	2,60	2,60	3,17	3,81	4,40	e)	e)
	25° < DN ≤ 40°	2,72	2,72	3,01	3,01	3,01	3,01	3,01	3,01	3,01	3,57	4,40	5,19	e)	e)
	40° < DN ≤ 60°	2,86	3,01	3,17	3,17	3,36	3,36	3,36	3,36	3,36	3,57	4,40	5,19	e)	e)
Snow load zone 3 ^{f)} Wind zone 2 ^{g)} Altitude NN ≤ 600 m	0° < DN ≤ 10°	1,79	1,79	1,97	2,04	2,04	2,04	2,04	2,12	2,60	3,81	4,40	5,19	e)	e)
	10° < DN ≤ 25°	2,29	2,29	2,48	2,60	2,60	2,60	2,60	2,72	3,36	4,76	e)	e)	e)	e)
	25° < DN ≤ 40°	2,38	2,48	2,72	2,72	2,72	2,86	2,86	2,86	3,57	5,19	e)	e)	e)	e)
	40° < DN ≤ 60°	2,60	2,60	2,86	2,86	2,86	2,86	2,86	3,01	3,57	5,19	e)	e)	e)	e)

a) Quantity always refers to the less favourable value from Topduo Flanged button-head and Cylinder-head

b) Topduo Flanged button-head only, c) Includes snow load zones 1, 2 and 2*, d) Includes all wind zones apart from North Sea islands

e) Use of our project assessment service is recommended. The design examples listed here represent unfavourable, i.e. statically safe, instances.

f) Includes snow load zones 1, 2 and 3, g) Includes wind zones 1 and 2 (inland)

Further assumptions:

Design with ECS design software in accordance with ETA-11/0024; screw-in angle 65°; gabled roof; ridge height above ground max. 18 m; gross density insulation 1,50 kN/m²; rafters C24 8/≥12 cm; counter batten C24 4/6 cm; rafter centre distance 0,70 m; roofing dead weight 0,55 kN/m²; snow guard available; quantity calculation regarding wind pressure after the most unfavourable roof area.

All listed values should be viewed as subject to the assumptions that have been made. They therefore represent example calculations and are subject to typographical and printing errors.

Please note: These are planning aids. Projects must only be calculated by authorised persons.

CALCULATING QUANTITIES FOR TOPDUO ROOFING SCREW STATICALLY PRESSURE-RESISTANT INSULATING MATERIALS AT $\sigma_{10} \% \geq 50$ KPA

Design sample for specified assumptions, project-related design may yield significantly more favourable results

Number of Topduo screws per m²

Insulation thickness		40	60	80	100	120	140	160	180	200	220	240	260	280	300
Boarding thickness (on rafters)		24	24	24	24	24	24	24	24	24	24	24	24	24	24
Dimensions Topduo Flanged button-head acc. Cylinder-head ^{a)}		8 x 195 ^{b)}	8 x 225	8 x 235	8 x 255	8 x 275	8 x 302	8 x 335	8 x 335	8 x 365	8 x 365	8 x 397	8 x 435	8 x 435	8 x 472 ^{b)}
		[mm]	[mm]	[mm]	[mm]	[mm]	[mm]	[mm]	[mm]	[mm]	[mm]	[mm]	[mm]	[mm]	[mm]
Snow load zone 2 ^{c)} Wind zone 4 ^{d)} Altitude NN ≤ 285 m	0° < DN ≤ 10°	1,96	2,06	2,06	2,06	2,06	2,06	2,06	2,06	2,06	2,06	2,12	1,80	2,40	2,32
	10° < DN ≤ 25°	2,11	2,05	1,97	1,94	1,97	1,90	1,85	2,14	2,01	2,74	2,57	2,38	3,23	2,93
	25° < DN ≤ 40°	2,48	2,41	2,28	2,35	2,41	2,35	2,18	2,67	2,49	3,48	3,22	2,96	4,42	3,79
	40° < DN ≤ 60°	2,31	2,30	2,56	2,65	2,74	2,65	2,42	2,96	2,74	4,00	3,70	3,48	4,87	4,47
Snow load zone 3 ^{f)} Wind zone 2 ^{g)} Altitude NN ≤ 400 m	0° < DN ≤ 10°	2,65	2,54	2,39	2,34	2,26	2,23	2,34	2,34	2,16	2,46	2,32	2,19	2,86	2,65
	10° < DN ≤ 25°	4,04	3,81	3,55	3,33	3,33	3,15	3,15	2,99	2,99	3,66	3,37	3,06	4,37	3,74
	25° < DN ≤ 40°	4,46	4,16	3,84	3,58	3,58	3,58	3,37	3,37	3,37	4,67	4,20	3,92	e)	e)
	40° < DN ≤ 60°	3,55	3,26	3,26	3,26	3,44	3,26	2,96	3,66	3,44	e)	4,67	4,27	e)	e)

a) Quantity always refers to the less favourable value from Topduo Flanged button-head and Cylinder-head

b) Topduo Flanged button-head only, c) Includes snow load zones 1, 2 and 2* each with snow guard, d) Includes all wind zones apart from North Sea islands

e) Use of our project assessment service is recommended. The design examples listed here represent unfavourable, i.e. statically safe, instances.

f) Includes snow load zones 1, 2 and 3, g) Includes wind zones 1 and 2 (inland)

Further assumptions:

Design with ECS design software in accordance with ETA-11/0024; screw-in angle roof thrust screw 65°/wind pressure screw 90°; gabled roof; ridge height above ground max. 18 m; gross density insulation 1,50 kN/m²; rafters C24 8/≥12 cm; counter batten C24 4/6 cm; rafter centre distance 0,70 m; roofing dead weight 0,55 kN/m²; snow guard available; quantity calculation with respect to wind pressure after the most unfavourable roof area.

All listed values should be viewed as subject to the assumptions that have been made. They therefore represent example calculations and are subject to typographical and printing errors.

Please note: These are planning aids. Projects must only be calculated by authorised persons.

Please note: Verify the assumptions made. The stated values, and type and number of joining devices are based on preliminary measurements. Projects are to be dimensioned exclusively by authorised persons in accordance with the State Building Code. As per LBauO, please contact a qualified structural engineer for a paid proof of stability. We will be happy to refer you to someone.

EuroTec calculation service

On-rafter insulation according to ETA-11/0024

by phone 02331 6245-444 · by fax 02331 6245-200 · by e-mail technik@eurotec.team

Please contact our technical department or use the free [calculation services](#) in the service section of our website.

Contact

Trader:	_____	Contractor:	_____
Contact person:	_____	Contact person:	_____
e-mail:	_____	Phone:	_____
Project:	_____	e-mail:	_____

Project details

Shed roof Gable roof Hip roof

Building length eave side: _____ m



Gable width: _____ m

Width counter batten: _____ mm
(min. 60 mm)

Rafter length: _____ m
(this information is optional)

Height counter batten: _____ mm
(min. 40 mm)

Ridge height: _____ m
(above ground)

Length counter batten: _____ m
(actual counter batten length to be installed)

Roof overhang: eave _____ / verge _____ m
(quantity is determined for total roof area)

Load from roofing and battens:

Roof pitch: main roof _____ / hip _____ °

Standing seam metal roofing 0,35 kN/m²

Concrete tile, clay tile 0,55 kN/m²

Insulation: _____

Flat tile roofing 0,75 kN/m²

Insulation thickness: _____ mm

or _____ kN/m²

Rafter width: _____ mm

Postcode of project: _____
(to determine the wind and snow load zone)

Rafter height: _____ mm

charact. snow load on ground sk: _____ /m²
(only for municipalities with special provision)

Rafter center distance: _____ mm

Site elevation above sea level: _____ m
(important for municipalities with complex relief)

Sheathing thickness: _____ mm

Snow guard provided? Yes No

Screw selection

Paneltwistec countersunk head* Paneltwistec washer head* Topduo flange button head screw** Topduo cylinder-head**

*only for compression-proof insulations with compression strength ≥ 50 kPa **also for non-compression-proof insulations

Eurotec[®]

Further products

Further products





Further products

Lifting anchor und ball supporting bolt	136 – 147
IdeeFix	148 – 155
SonoTec sond insulation cork	156 – 167
Bolt anchor	168 – 171
Silent EPDM decoupling profile	172 – 173
Ectec	174 – 175

LIFTING ANCHOR UND BALL SUPPORTING BOLT

FOR THE TRANSPORT OF PREFABRICATED WALL MODULES



ADVANTAGES

- Easy assembly
- Reusable corpus
- Can be used in solid structural timber and cross-laminated timber
- Especially made for transporting large loads
- 360° rotation of the load is possible



DESCRIPTION

The lifting anchor is specifically designed for use with a ball supporting bolt. The lifting anchor can be used to transport prefabricated wall modules. The fact that it is set with screws means the anchor can be used several times. 8 screws are included in delivery.

INSTRUCTIONS FOR USE

The product only works in combination with the ball supporting bolt (Ø: 20 mm, l: 50 mm) provided for this purpose.
The specifications of the product data sheet must be observed!
Please consult with our technical department and download the product data sheet from our website www.eurotec.team runter.

Please note! This product is subject to important conditions! Please observe the instructions of use. To be able to ensure the safety of transport, the screws must be replaced after use.



Application of lifting anchor to transport a wall.

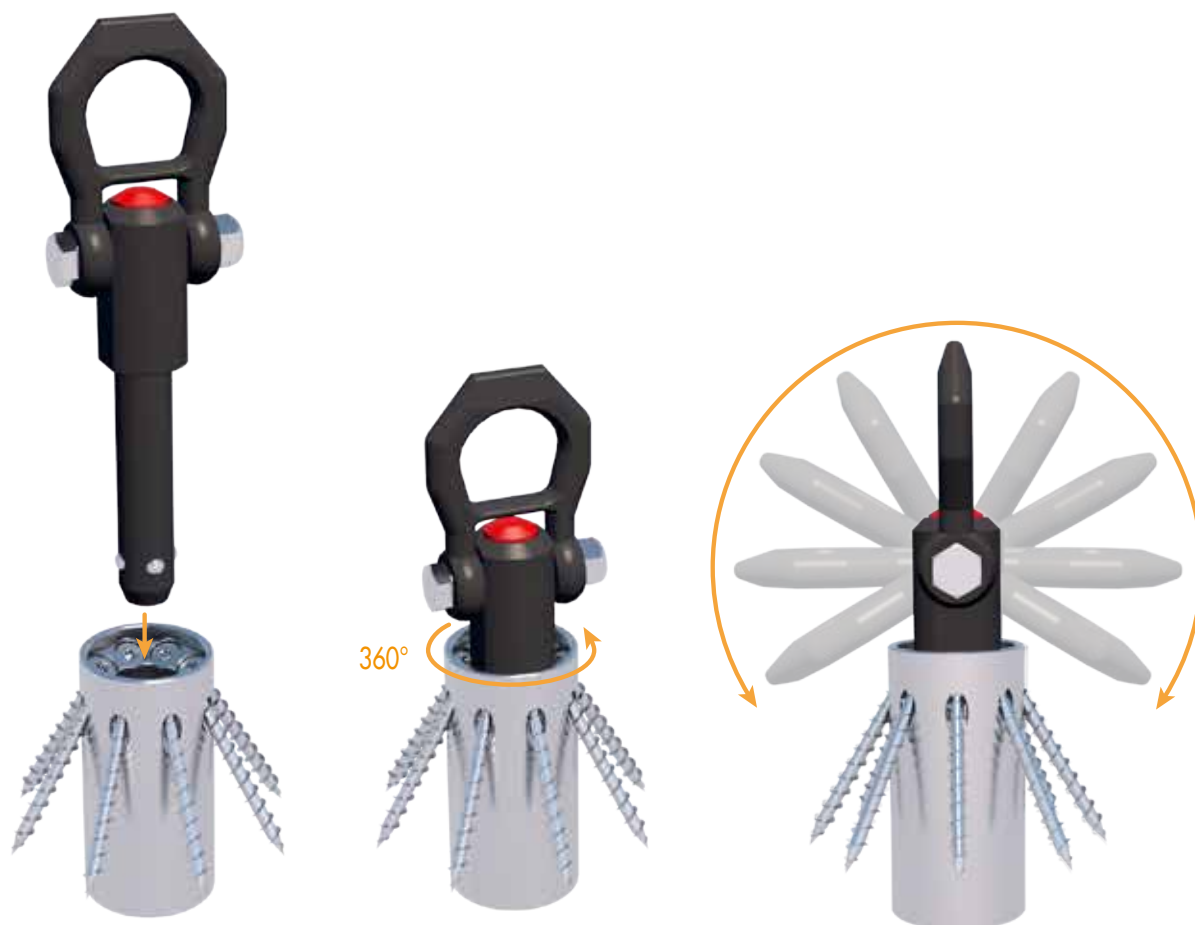

Self-alignment of the leg in the direction of force

ONLY TO BE CARRIED OUT BY QUALIFIED PROFESSIONALS!

Minimum width of the material: 120 mm
 Minimum thickness of the material: 60 mm
 Bis 80 mm material thickness: Through bore
 From 80 mm+: Blind hole / pocket

Art. no.	Name	Dimensions [mm] ^{a)}	Material	PU*
944892	Lifting anchor	60 x 40	SJ235	4

a) Height x Diameter

*Delivery incl. screws

Art. no.	Name	Dimensions [mm] ^{a)}	Material	F1 [kN]	F2 [kN]	F3 [kN]	PU
944893	Ball supporting bolt	50 x 20	SJ235	10	8,5	6,5	1

a) Height x Diameter



Horizontal transport e.g. for ceiling elements



Rotatable ball supporting bolt enables flexible transport

TRANSPORTATION OF SMALLER ELEMENTS

NEU
 in unserem Sortiment



DESCRIPTION LIFTING ANCHOR MINI

The new Lifting anchor Mini is particularly suitable for transporting smaller loads, such as beam girders or supports. Since the inner diameter has been reduced from \varnothing 20 mm (Lifting anchor) to \varnothing 16 mm (Lifting anchor Mini), there is also a new smaller ball supporting bolt. A special feature of the Lifting anchor Mini is a stop on the upper edge, which simplifies installation in the case of a through hole.

Art. no.	Name	Dimensions [mm] ^{a)}	Material	PU*
944901	Lifting Anchor Mini	49 x 45	S235R	4
a) Height x Diameter				
*Incl. 8 TX25 fully threaded screws TX25 6,0 x 60				

Art. no.	Name	Dimensions [mm] ^{a)}	Material	F1 [kN]	F2 [kN]	F3 [kN]	PU
944893	Ball supporting bolt	50 x 20	SJ235	10	8,5	6,5	1
a) Height x Diameter							

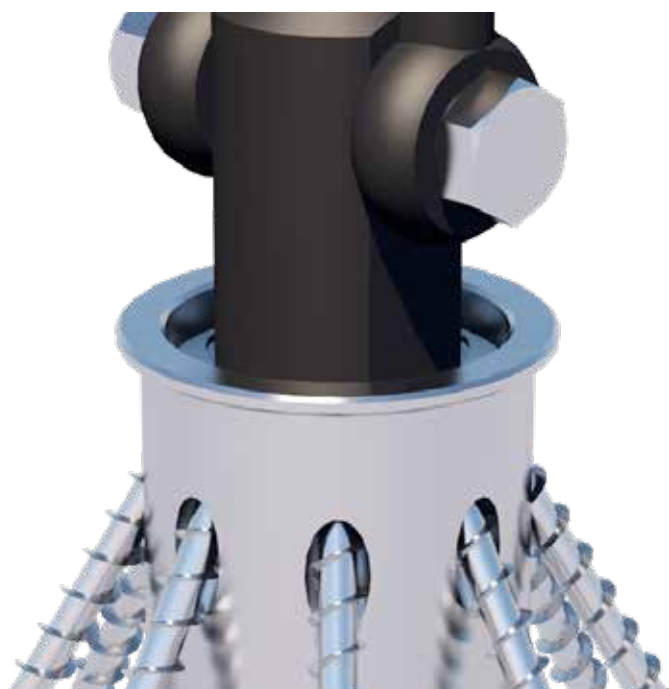
 THE STOP WILL BE
 ADDED TO OUR
LIFTING ANCHOR
 SOON!
 



LIFTING ANCHOR

TECHNICAL INFORMATION



HORIZONTAL WALL OR BEAM: SET UPRIGHT, THEN LIFT

CLT - wall or beam			
Connection in the	Connector	Stop bracket β	Total weight [kg] with 2 strands
End grain area	Lifting anchor $\varnothing 40\text{mm} + 8 \times \text{VSS } 6 \times 60$	30°	444
		45°	528
		60°	569
		75°	588
		β	with n strands
		90°	n x 297

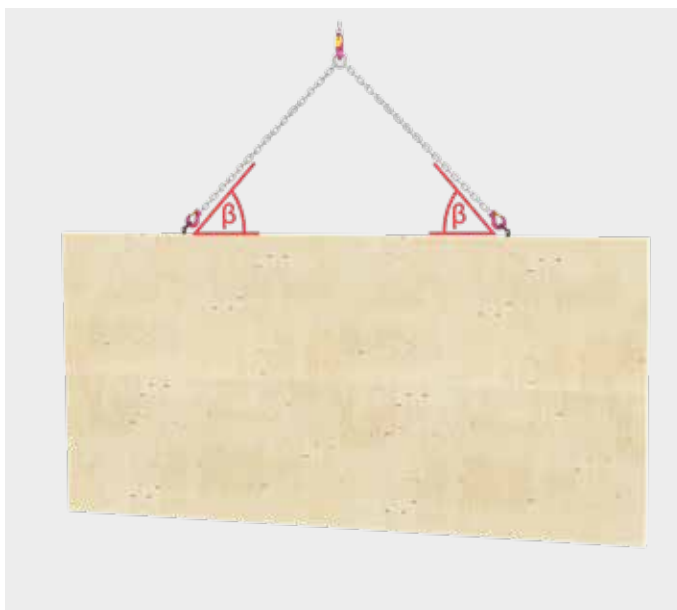
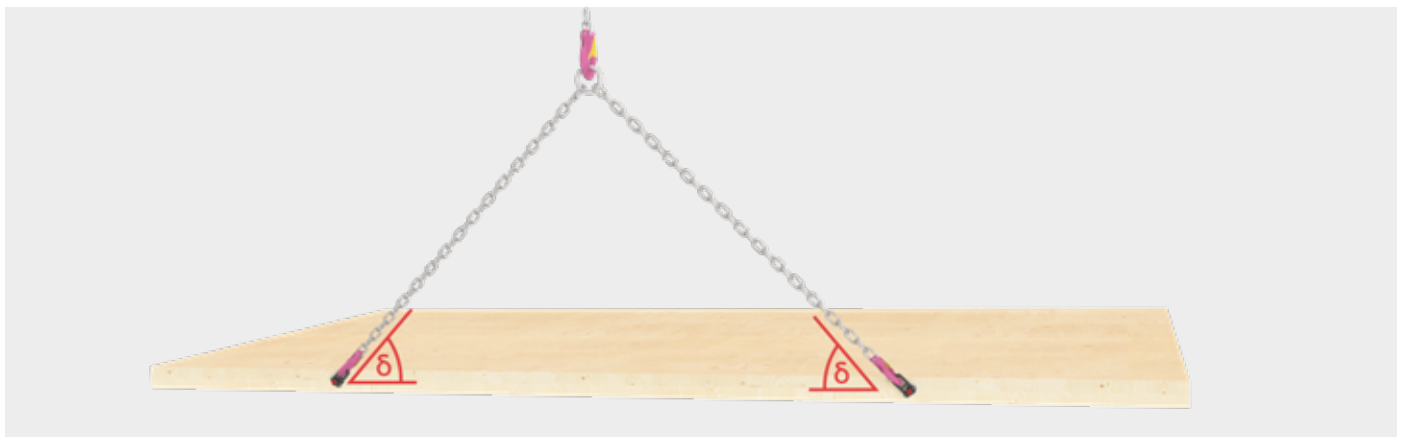

i

Note

The tables illustrate the 'Setting upright and subsequently lifting a horizontal wall or horizontal beam' load case (lifting from a horizontal position leading to vertical suspension). The connectors are to be screwed flush, as well as at right angles to the surfaces of the narrow sides and side or end grain surfaces, into the centre plane of the components.

VERTICAL WALL OR BEAM: LIFT

		CLT - wall or beam	
Connection in the	Connector	Stop bracket β	Total weight [kg] with 2 strands
Narrow surface	Lifting Anchor $\varnothing 40\text{mm}$ + 8 x VSS 6 x 60	30°	601
		45°	886
		60°	1135
		75°	1311
		β	bei n Strängen
		90°	n x 688

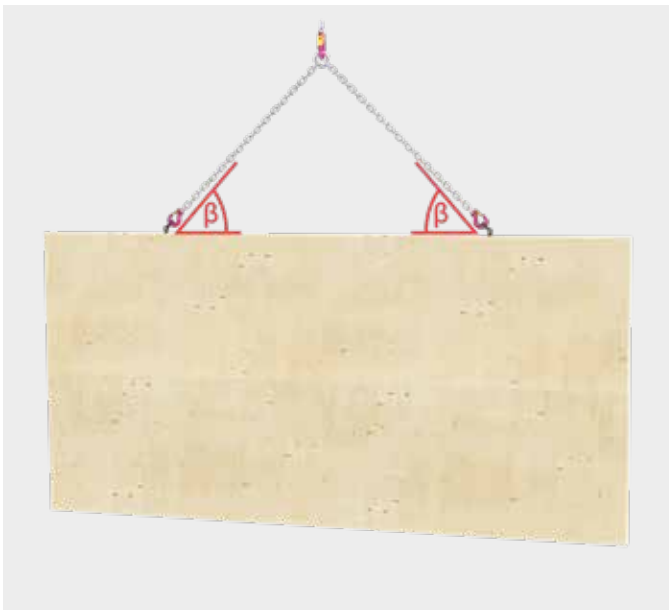

i

Note

The tables illustrate an example of "Lifting a standing wall or beam". (Lifting from the horizontal to vertical suspension). The table values are only valid for lifting or assembly states.

CEILING LYING: LIFTING

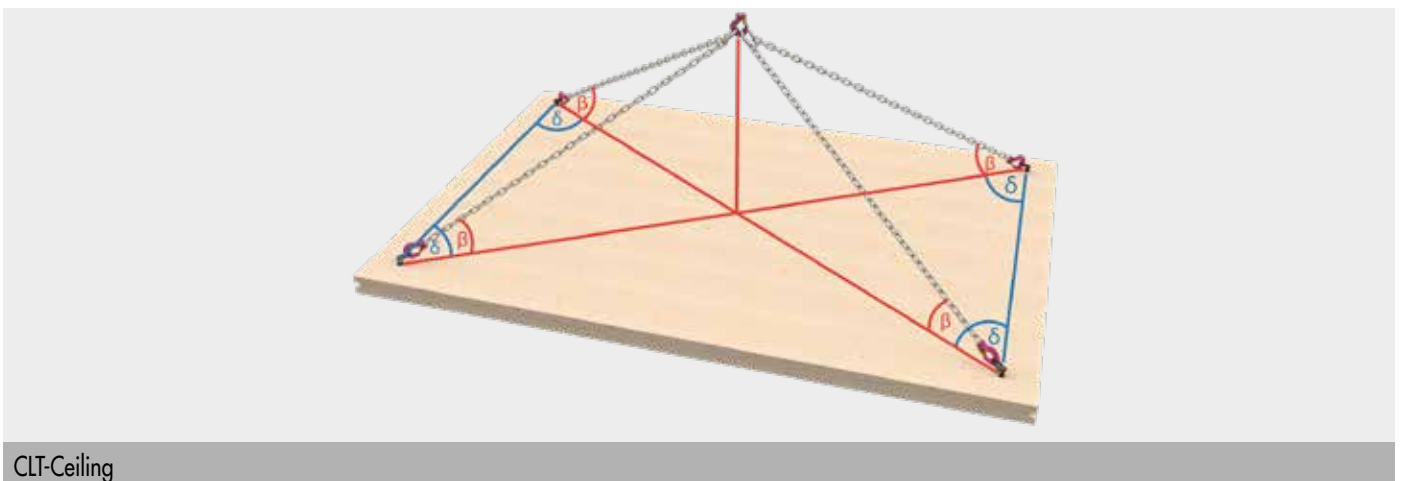

CLT-Ceiling

(TABLE ON THE NEXT PAGE)

Please note: Verify the assumptions made. The stated values, and type and number of joining devices are based on preliminary measurements. Projects are to be dimensioned exclusively by authorised persons in accordance with the State Building Code. As per LBau0, please contact a qualified structural engineer for a paid proof of stability. We will be happy to refer you to someone.

CLT-Ceiling

Connection in the	Connector	Stop bracket	Ground plan bracket	Total weight [kg]
		β	δ	with 4 strands
Side area	Lifting anchor + 8 x VSS 6 x 60	30°	5°	1193
			15°	1121
			25°	1015
			35°	911
			45°	824
			60°	732
			75°	682
		45°	5°	1762
			15°	1683
			25°	1559
			35°	1429
			45°	1314
			60°	1187
			75°	1091
		60°	5°	2262
			15°	2205
			25°	2108
			35°	1995
			45°	1887
			60°	1756
			75°	1649
		75°	5°	2620
			15°	2600
			25°	2564
			35°	2518
			45°	2469
			60°	2401
			75°	2339
		β	δ	with 2 strands
		30°	0°	1203
90°	333			
45°	0°	1773		
	90°	545		
60°	0°	2270		
	90°	824		
75°	0°	2623		
	90°	1169		
β	δ	with n strands		
90°	0°	688		

**Notes**

The tables illustrates an example of "Lifting of horizontal ceiling elements". (Lifting from the horizontal to vertical suspension). The connectors must be screwed in flush with the surface, plus perpendicular to the component surface.

OPERATING INSTRUCTIONS FOR THE BALL SUPPORTING BOLT

Warning!

Ball supporting bolts are designed for lifting and holding individual loads (**not people!**). In addition, they are not suitable for continuous load rotation. Contamination (e.g. grinding sludge, oil and emulsion deposits, dust, etc.) can impair the function of ball supporting bolts.

Damaged ball supporting bolts can put people's lives at risk. Before each use, ball supporting bolts must be inspected for visible defects (e.g. deformations, fractures, cracks, damage, missing balls, corrosion, function of the unlocking mechanism).

Damaged ball supporting bolts must be withdrawn from further use.

Handling and loading

Press the button (A) to release the balls. The balls are locked again by releasing the button (A).

Please note: The button (A) is locked when the spring force has caused it to spring back to its original position. Do not press the button when loaded!

The load values F1 / F2 / F3 (see page 2) apply to lifting in a steel receptacle and x min. = 1.5 mm

Maintenance

Ball supporting bolts must be subjected to a safety inspection by a competent person at least once a year.

Visual inspection

Deformations, fractures, cracks, missing / damaged balls, corrosion, screw connection damage on the shackle.

Functional test

The balls' locking and unlocking mechanism must close automatically by spring force. Full shackle mobility is guaranteed.



d ₁	l ₁	d ₂	d ₃	d _{4 min.}	l ₂	l ₃	l ₄	l ₅	l ₆	l ₇	l ₈	x min.*	x max.*	D H11	F ₁ kN*	F ₂ kN*	F ₃ kN*
20,0	50	24,50	30,0	25,00	19,70	36,5	52,0	32,6	36	56	114,0	1,5	25	20,0	10,0	8,5	6,5

*with five-fold protection against breakage

**Original EC conformity mark**

The product complies with the regulations set down in the EC Directive 2006/42/EC.

Make: Ball supporting bolt

Type: EH 22350

Applied standards: DIN EN 13155

Please note: Verify the assumptions made. The stated values, and type and number of joining devices are based on preliminary measurements. Projects are to be dimensioned exclusively by authorised persons in accordance with the State Building Code. As per LBau0, please contact a qualified structural engineer for a paid proof of stability. We will be happy to refer you to someone.

LIFTING ANCHOR MINI

TECHNICAL INFORMATION



HORIZONTAL WALL OR BEAM: SET UPRIGHT, THEN LIFT

		CLT - Wall or beam	
Connection in the	Connector	Stop bracket	Total weight [kg]
		β	with 2 strands
End grain area	Lifting anchor mini $\varnothing 40\text{mm} + 8 \times \text{VSS } 6 \times 60$	30°	248
		45°	295
		60°	318
		75°	328
		β	with n strands
		90°	n x 166

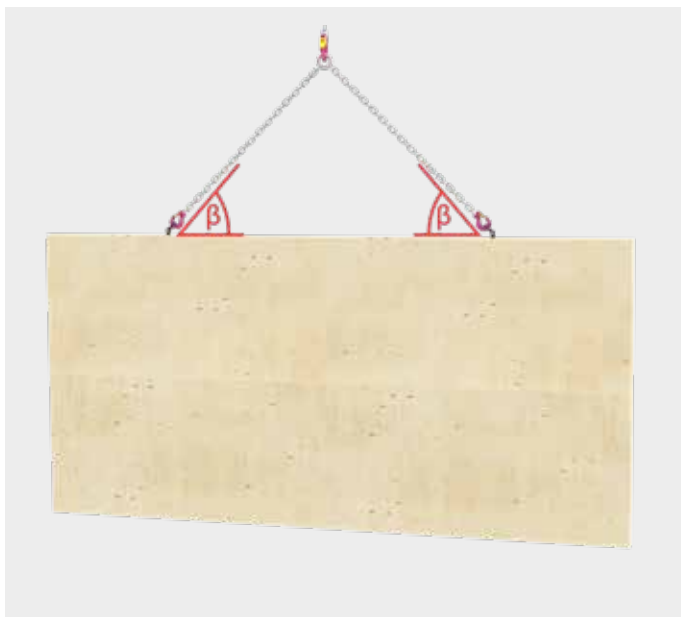
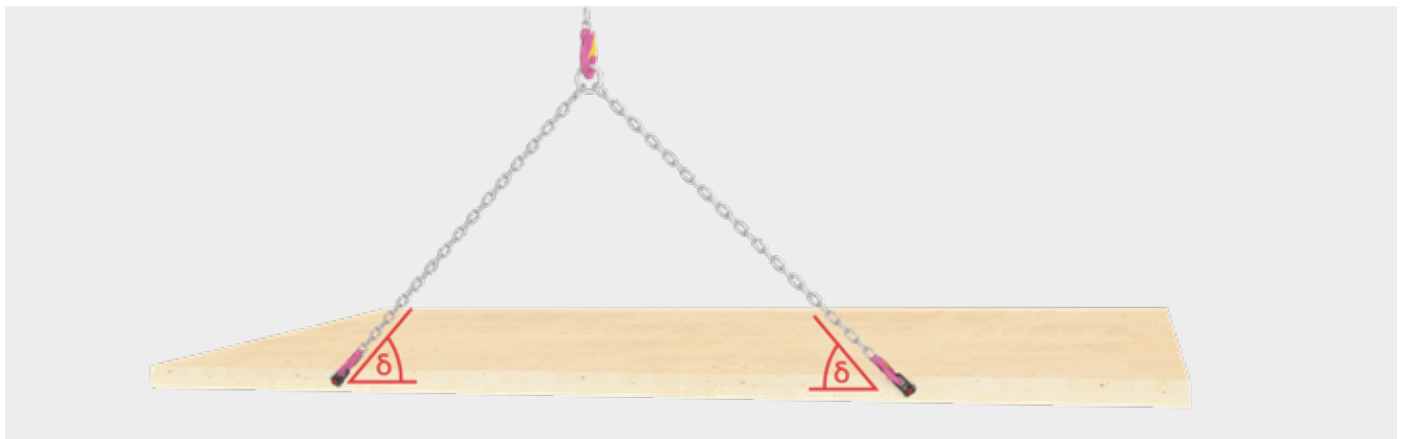

i

Note

The tables illustrate the 'Setting upright and subsequently lifting a horizontal wall or horizontal beam' load case (lifting from a horizontal position leading to vertical suspension). The connectors are to be screwed flush, as well as at right angles to the surfaces of the narrow sides and side or end grain surfaces, into the centre plane of the components.

VERTICAL WALL OR BEAM: LIFT

CLT - Wall or beam			
Connection in the	Connector	Stop bracket	Total weight [kg] with 2 strands
		β	
Narrow surface	Lifting anchor mini Ø40mm+ 8 x VSS 6 x 60	30°	360
		45°	585
		60°	869
		75°	1196
		β	with n strands
		90°	n x 688

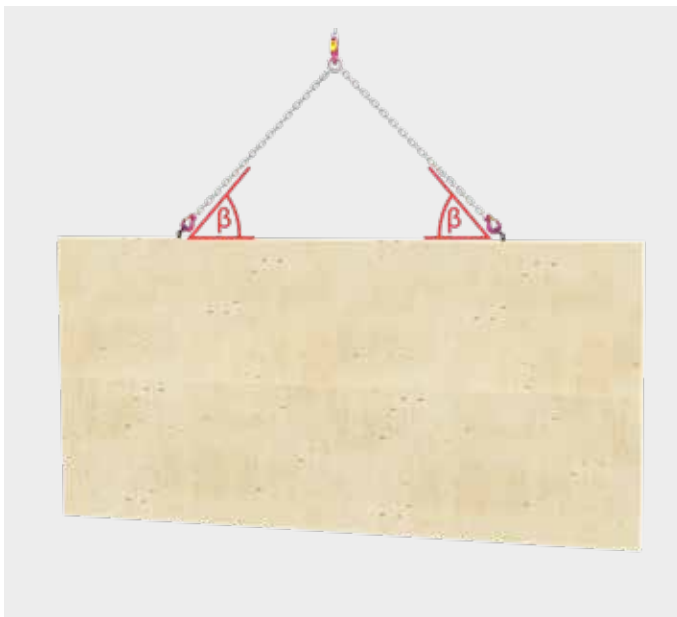

i

Note

The tables illustrate an example of "Lifting a standing wall or beam". (Lifting from the horizontal to vertical suspension). The table values are only valid for lifting or assembly states.

CEILING LYING: LIFTING

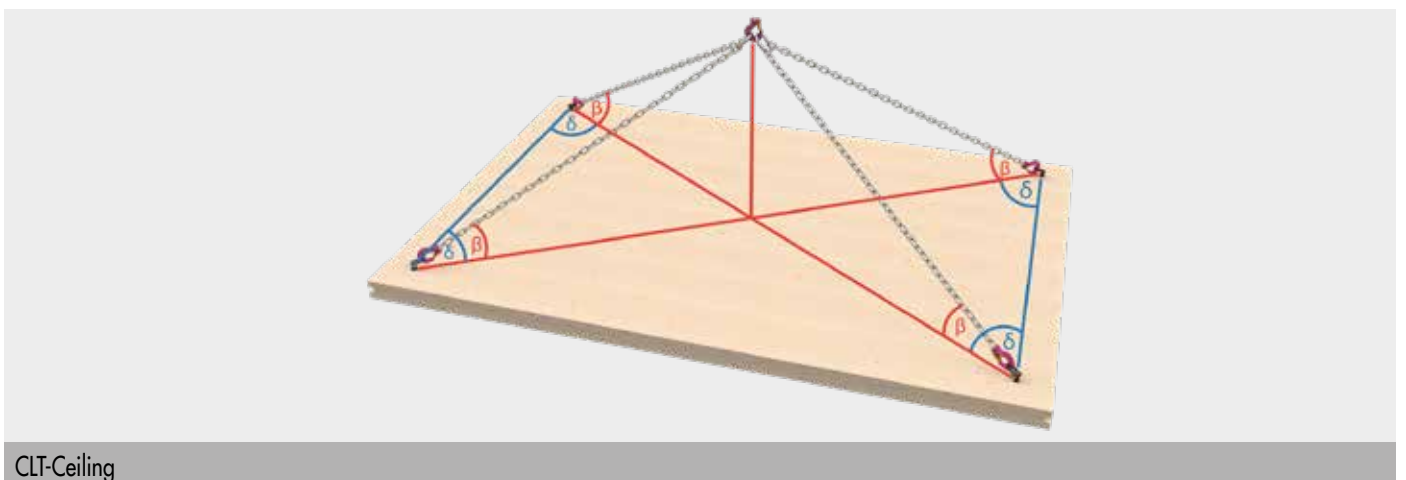

CLT-Ceiling

(TABLE ON THE NEXT PAGE)

Please note: Verify the assumptions made. The stated values, and type and number of joining devices are based on preliminary measurements. Projects are to be dimensioned exclusively by authorised persons in accordance with the State Building Code. As per LBauO, please contact a qualified structural engineer for a paid proof of stability. We will be happy to refer you to someone.

CLT - Ceiling

Connection in the	Connectors	Stop bracket	Ground plan bracket	Total weight [kg]
		β	δ	with 4 strands
Side area	Lifting anchor + 8 x VSS 6 x 60	30°	5°	714
			15°	665
			25°	595
			35°	529
			45°	475
			60°	419
			75°	389
		45°	5°	1161
			15°	1091
			25°	986
			35°	884
			45°	799
			60°	710
			75°	645
		60°	5°	1727
			15°	1648
			25°	1524
			35°	1394
			45°	1281
			60°	1155
			75°	1061
		75°	5°	2385
			15°	2339
			25°	2257
			35°	2160
			45°	2063
			60°	1943
			75°	1841
		β	δ	with 2 strands
		30°	0°	721
90°	189			
45°	0°	1171		
	90°	322		
60°	0°	1738		
	90°	530		
75°	0°	2392		
	90°	920		
β	δ	with n strands		
90°	0°	n x 688		

**Note**

The tables illustrate an example of "Lifting of horizontal ceiling elements". (Lifting from the horizontal to vertical suspension). The connectors must be screwed in flush with the surface, plus perpendicular to the component surface.

OPERATING INSTRUCTIONS FOR THE BALL SUPPORTING BOLT

Warning!

Ball supporting bolts are designed for lifting and holding individual loads (**not people!**). In addition, they are not suitable for continuous load rotation. Contamination (e.g. grinding sludge, oil and emulsion deposits, dust, etc.) can impair the function of ball supporting bolts.

Damaged ball supporting bolts can put people's lives at risk. Before each use, ball supporting bolts must be inspected for visible defects (e.g. deformations, fractures, cracks, damage, missing balls, corrosion, function of the unlocking mechanism).

Damaged ball supporting bolts must be withdrawn from further use.

**Handling and loading**

Press the button (A) to release the balls. The balls are locked again by releasing the button (A).

Please note: The button (A) is locked when the spring force has caused it to spring back to its original position. Do not press the button when loaded!

The load values F1 / F2 / F3 (see page 2) apply to lifting in a steel receptacle and x min. = 1.5 mm

**Maintenance**

Ball supporting bolts must be subjected to a safety inspection by a competent person at least once a year.

Visual inspection

Deformations, fractures, cracks, missing / damaged balls, corrosion, screw connection damage on the shackle.

Functional test

The balls' locking and unlocking mechanism must close automatically by spring force. Full shackle mobility is guaranteed.

d ₁	l ₁	d ₂	d ₃	d _{4 min.}	l ₂	l ₃	l ₄	l ₅	l ₆	l ₇	l ₈	x min.*	x max.*	D H11	F ₁ kN*	F ₂ kN*	F ₃ kN*
20,0	50	24,50	30,0	25,00	19,70	36,5	52,0	32,6	36	56	114,0	1,5	25	20,0	10,0	8,5	6,5

*with five-fold protection against breakage

**Original EC conformity mark**

The product complies with the regulations set down in the EC Directive 2006/42/EC.

Make: Ball supporting bolt

Type: EH 22350

Applied standards: DIN EN 13155

Please note: Verify the assumptions made. The stated values, and type and number of joining devices are based on preliminary measurements. Projects are to be dimensioned exclusively by authorised persons in accordance with the State Building Code. As per LBau0, please contact a qualified structural engineer for a paid proof of stability. We will be happy to refer you to someone.

IDEEFIX

HIDDEN WOOD CONNECTOR



ADVANTAGES

- High load absorption for tensile and transverse loads
- Adjustable tension/detachable
- Universal application
- Low wood-weakening effect
- For single- or multiple-row serial connections
- High extraction resistance
- Strong connection
- Maximization of load capacity
- Time and cost saving alternative
- Non-visible connections
- According to approval/ETA no predrilling for screws required (from screw lengths > 245 mm recommended)



INSTRUCTIONS FOR USE

The wood is predrilled for the IdeeFix. Then the IdeeFix is first inserted into the drill hole without screws. Then, thanks to its low splitting effect, the screws can be inserted without further predrilling. In the middle of the IdeeFix is a thread into which another screw can be inserted.



IdeeFix application for connecting column and beam girder

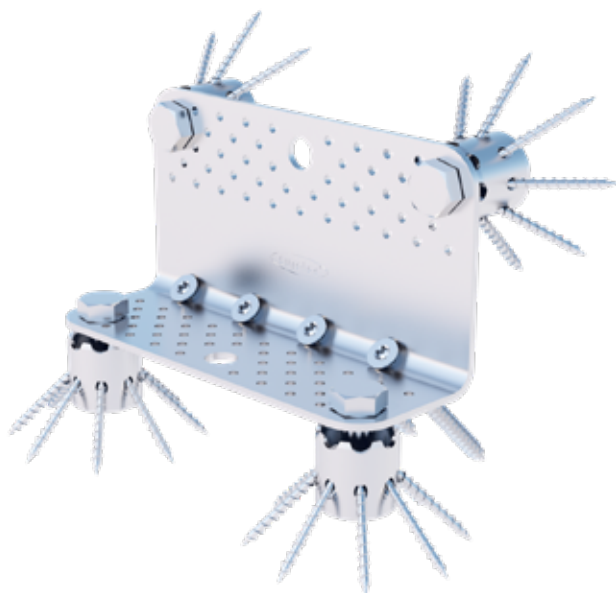

CLT system angle with IdeeFix

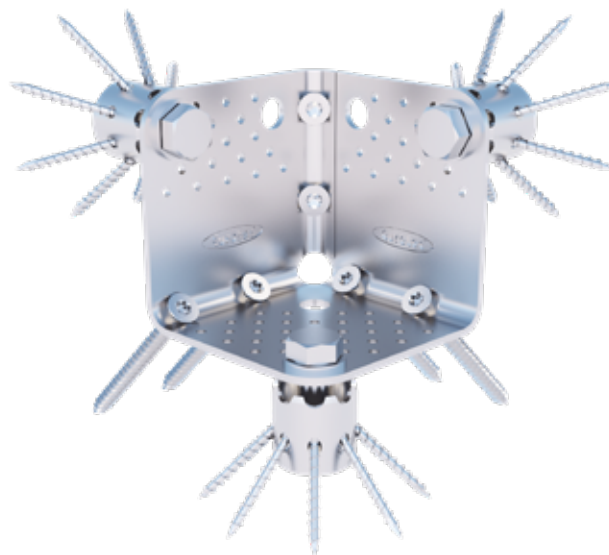

CLT system inside corner with IdeeFix

IdeeFix 30



Art. no.	Diameter/Height [mm]	PU
945390	30	25
Incl. fully threaded screws 5,0 x 40 mm		

IdeeFix 40



Art. no.	Diameter/Height [mm]	PU
944890	40	25
Incl. fully threaded screws 6,0 x 60 mm		

IdeeFix 50



Art. no.	Diameter/Height [mm]	PU
944896	50	25
Incl. fully threaded screws 8,0 x 90 mm		

1 Drill



2 Insert and install supplied screws



3 Fix construction in place with construction screws – Done!

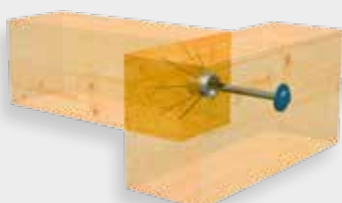

IDEEFIX 30/40/50

TECHNICAL INFORMATION

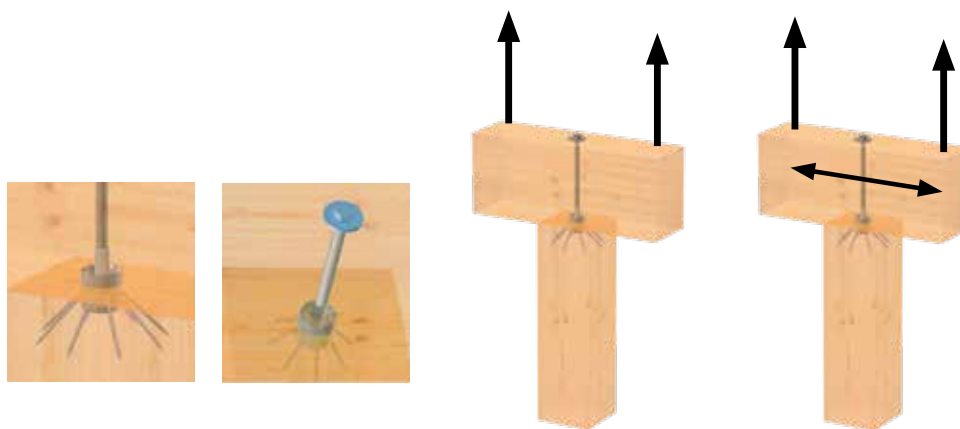

IdeeFix			Timber Dimensions		Tension connection with anti-twist element		Mortise joint with anti-twist element		Tensile load with threaded bolt		
Dimensions [mm]			Min. cross section post		Drilling depth for post	Drilling depth for cross-piece	Drilling depth for post	Drilling depth for cross-piece	Perm. Values	Char. Values	Screw pattern
d_c	a_g	v_c	[mm]	[mm]	[mm]	[mm]	[mm]	[mm]	N_{ze} [kN]	$R_{1,t,k}$ [kN]	pc.
30	M12	3	80	80	27	-	20	7	7,62	17,33	
40	M16	5	120	120	35	-	25	10	12,65	28,79	
50	M20	5	160	160	45	-	30	15	20,81	47,35	
30	M12	3	60	80	27	-	20	7	5,71	13,00	
40	M16	5	80	120	35	-	25	10	9,49	21,59	
50	M20	5	120	160	45	-	30	15	15,61	35,51	
30	M12	3	40	80	27	-	20	7	3,81	8,67	
40	M16	5	60	120	35	-	25	10	6,33	14,39	
50	M20	5	80	160	45	-	30	15	10,41	23,67	
30	M12	3	60	60	27	-	20	7	3,81	8,67	
40	M16	5	80	80	35	-	25	10	6,33	14,39	
50	M20	5	120	120	45	-	30	15	10,41	23,67	

d_c is the diameter and the total height of the connector

a_g is the metric connection thread of the connector

v_c is the height of the integrated anti-twist system

Fully threaded screw, GoFix® FK IF 30 5,0 x 40 mm - IF 40 6,0 x 60 mm - IF 50 8,0 x 90 mm

The connection is drawn together using a threaded rod or construction screw with a DIN 440 R washer

Tension connection as a mortise joint with simultaneous absorption of transverse forces

R_k characteristic value calculated according to DIN 1052:2004-08 Timber ρ_k 380 kg/m³ N_{ze} recommended permissible load $R_{k} \times 0,8 k_{mod} : 1,3 \text{ ym} : 1,4$. Factor 1,4 average load safety factor

Please note: The stated values are planning aids. Projects must only be calculated by authorised persons.

MAIN-SECONDARY BEAM

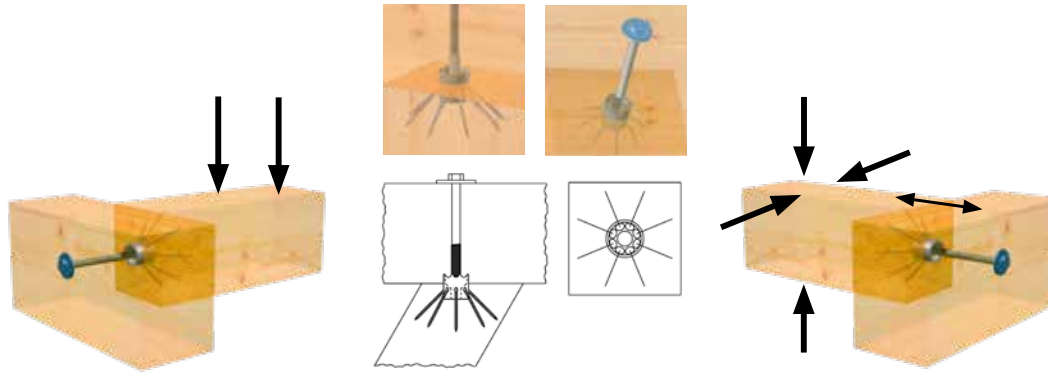

IdeeFix			Timber Dimensions		Timber Dimensions		Main-secondary beam with anti-twist element		Load-bearing capacity with threaded bolt		
Dimensions [mm]			Min. cross section of secondary beam		Min. cross section of main beam		Drilling depth for SB	Drilling depth for MB	Perm. Values	Char. Values	Screw pattern
d_c	a_g	v_c	w [mm]	h [mm]	w [mm]	h [mm]	[mm]	[mm]	V_{ze} [kN]	$R_{23,k}$ [kN]	pc.
30	M12	3	80	80	80	80	20	7	4,32	8,94	
40	M16	5	120	120	120	120	25	10	6,98	14,66	
50	M20	5	160	160	160	160	30	15	10,88	21,09	
30	M12	3	60	80	60	80	20	7	3,50	7,97	
40	M16	5	80	120	80	120	25	10	5,63	12,80	
50	M20	5	120	160	120	160	30	15	8,65	19,68	
30	M12	3	40	80	40	80	20	7	3,50	7,97	
40	M16	5	60	120	60	120	25	10	5,63	12,80	
50	M20	5	80	160	80	160	30	15	8,65	19,68	
30	M12	3	60	60	60	60	20	7	3,50	7,97	
40	M16	5	80	80	80	80	25	10	5,63	12,80	
50	M20	5	120	120	120	120	30	15	8,65	19,68	

d_c is the diameter and the total height of the connector

a_g is the metric connection thread of the connector

v_c is the height of the integrated anti-twist system

System – Fully threaded screw, GoFix® FK IF 30 5,0 x 40 mm - IF 40 6,0 x 60 mm - IF 50 8,0 x 90 mm

The connection is drawn together using a threaded rod or construction screw with a DIN 440 R washer

MB-SB connection as a mortise joint with simultaneous absorption of tensile forces

R_k characteristic value calculated according to DIN 1052:2004-08 Timber p_k 380 kg/m³ Nze. recommended permissible load $R_{k,k} \times 0,8$ k_{mod} : 1,3 γ_m : 1,4. Factor 1,4 average load safety factor

Please note: The stated values are planning aids. Projects must only be calculated by authorised persons.

MAIN-SECONDARY BEAM, DOUBLE-SIDED CONNECTION, WITH FIXING SCREW

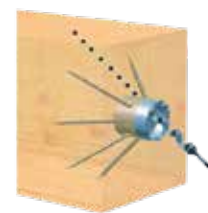
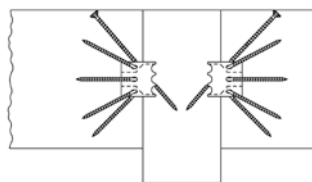
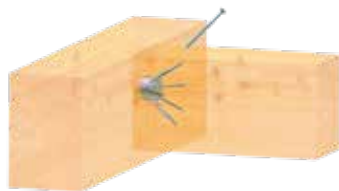
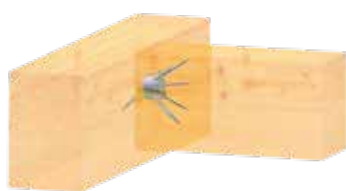

IdeeFix			Timber Dimensions		Timber Dimensions		Main-secondary beam with anti-twist element		Load-bearing capacity with threaded bolt		
Dimensions [mm]			Min. cross section of secondary beam		Min. cross section of main beam		Drilling depth for SB	Drilling depth for MB	Perm. Values	Char. Values	Screw pattern
d_c	a_g	v_c	w [mm]	h [mm]	w [mm]	h [mm]	[mm]	[mm]	V_{ze} [kN]	$R_{23,k}$ [kN]	pc.
30	M12	3	80	80	80	80	20	10	2,34	5,32	
40	M16	5	120	120	120	120	25	15	3,60	8,19	
50	M20	5	160	160	160	160	30	20	5,03	11,44	
30	M12	3	60	80	60	80	20	10	2,34	5,32	
40	M16	5	80	120	80	120	25	15	3,60	8,19	
50	M20	5	120	160	120	160	30	20	5,03	11,44	
30	M12	3	40	80	40	80	20	10	2,34	5,32	
40	M16	5	60	120	60	120	25	15	3,60	8,19	
50	M20	5	80	160	80	160	30	20	5,03	11,44	
30	M12	3	60	60	60	60	20	10	2,34	5,32	
40	M16	5	80	80	80	80	25	15	3,60	8,19	
50	M20	5	120	120	120	120	30	20	5,03	11,44	

d_c is the diameter and the total height of the connector

a_g is the metric connection thread of the connector

v_c is the height of the integrated anti-twist system

System – Fully threaded screw, Gofix® FK IF 30 5,0 x 40 mm - IF 40 6,0 x 60 mm - IF 50 8,0 x 90 mm

Position retention using Gofix® SK IF 30 5,0 x 100 mm, IF 40 6,0 x 140 mm, IF 50 8,0 x 160 mm

MB-SB connection as mortise joint for double-sided connection of secondary beam

R_k characteristic value calculated according to DIN 1052:2004-08 Timber p_k 380 kg/m³ Nze. recommended permissible load $R_{k,k} \times 0,8$ k_{mod} : 1,3 γ_m : 1,4. Faktor 1,4 average load safety factor

Please note: The stated values are planning aids. Projects must only be calculated by authorised persons.

MAIN-SECONDARY BEAM MULTIPLE CONNECTION, SINGLE-ROW

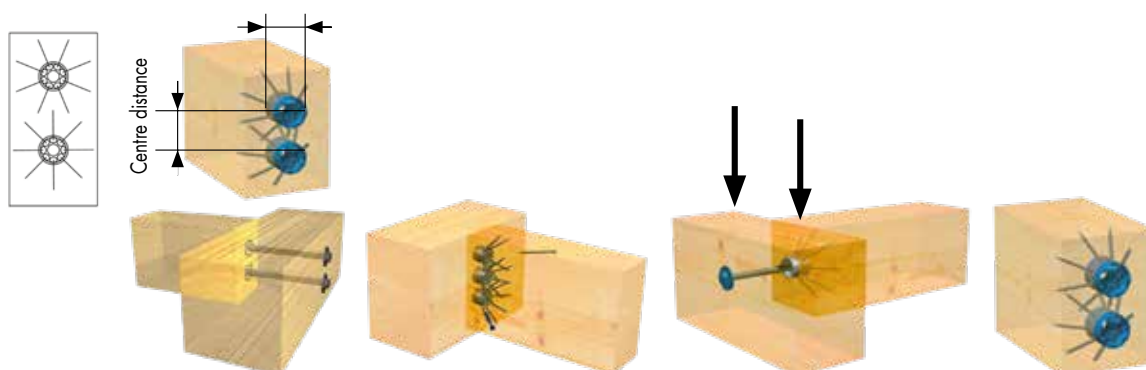

IdeeFix			Timber Dimensions		Edge and centre distance		Main-secondary beam Multiple connection		Load-bearing capacity Single-row		
Dimensions [mm]			Min. cross section of secondary beam		Edge distance	Centre distance	Drilling depth for SB	Drilling depth for MB	Perm. Values	Char. Values	Number of Connectors
d _c	a _g	v _c	w [mm]	h [mm]	[mm]	[mm]	[mm]	[mm]	V _{ze} [kN]	R _{23,k} [kN]	pc.
30	M12	3	80	80	50	50	20	7	4,32	8,94	1
40	M16	5	120	120	60	60	25	10	6,98	14,66	1
50	M20	5	160	160	80	80	30	15	10,88	21,09	1
30	M12	3	80	150	50	50	20	10	8,64	17,88	2
40	M16	5	120	180	60	60	25	15	13,96	29,32	2
50	M20	5	160	240	80	80	30	20	21,76	42,18	2
30	M12	3	80	200	50	50	20	10	12,96	26,82	3
40	M16	5	120	240	60	60	25	15	20,94	43,98	3
50	M20	5	160	320	80	80	30	20	32,64	63,27	3
30	M12	3	80	250	50	50	20	10	17,28	35,76	4
40	M16	5	120	300	60	60	25	15	27,92	58,64	4
50	M20	5	160	400	80	80	30	20	43,52	84,36	4
30	M12	3	80	300	50	50	20	10	21,60	44,70	5
40	M16	5	120	360	60	60	25	15	34,90	73,30	5
50	M20	5	160	480	80	80	30	20	54,40	105,45	5
30	M12	3	80	350	50	50	20	10	25,92	53,64	6
40	M16	5	120	420	60	60	25	15	41,88	87,96	6
50	M20	5	160	560	80	80	30	20	65,28	126,54	6
30	M12	3	80	400	50	50	20	10	30,24	62,58	7
40	M16	5	120	480	60	60	25	15	48,86	102,62	7
50	M20	5	160	640	80	80	30	20	76,16	117,63	7
30	M12	3	80	450	50	50	20	10	34,56	71,52	8
40	M16	5	120	540	60	60	25	15	55,84	117,28	8
50	M20	5	160	720	80	80	30	20	87,04	168,72	8

d_c is the diameter and the total height of the connector

a_g is the metric connection thread of the connector

v_c is the height of the integrated anti-twist system – Fully threaded screw, GoFix® FK

IF 30 5,0 x 40 mm - IF 40 6,0 x 60 mm - IF 50 8,0 x 90 mm

The connection is drawn together using a threaded rod or construction screw with a DIN 440 R washer



MB-SB connection as a mortise joint with simultaneous absorption of tensile forces

R_k characteristic value calculated according to DIN 1052:2004-08 Timber p_k 380 kg/m³ Nze. recommended permissible load R_k x 0,8 k_{mod} : 1,3 ym : 1,4. Favtor 1,4 average load safety factor

Please note: The stated values are planning aids. Projects must only be calculated by authorised persons.

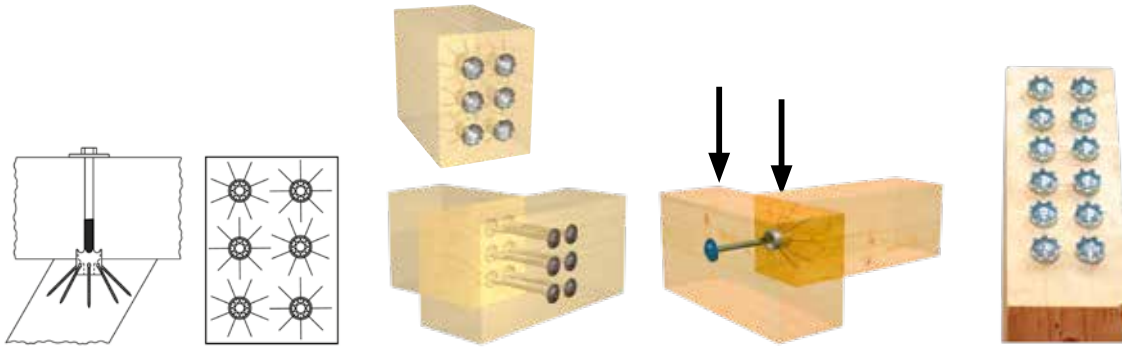
MAIN-SECONDARY BEAM MULTIPLE CONNECTION, DOUBLE-ROW



IdeeFix			Timber Dimensions		Edge and centre distance		Main-secondary beam Multiple connection		Load-bearing capacity Single-row			
Dimensions [mm]			Min. cross section of secondary beam		Edge distance	Centre distance	Drilling depth for SB	Drilling depth for MB	Perm. Values	Char. Values	Number of connectors	
d_c	a_g	v_c	w [mm]	h [mm]	[mm]	[mm]	[mm]	[mm]	V_{ze} [kN]	$R_{23,k}$ [kN]	pc.	
30	M12	3	150	80	50	50	20	10	8,64	17,88	2	
40	M16	5	180	120	60	60	25	15	13,96	29,32	2	
50	M20	5	240	160	80	80	30	20	21,76	42,18	2	
30	M12	3	150	150	50	50	20	10	17,28	35,76	4	
40	M16	5	180	180	60	60	25	15	27,92	58,64	4	
50	M20	5	240	240	80	80	30	20	43,52	84,36	4	
30	M12	3	150	200	50	50	20	10	25,92	53,64	6	
40	M16	5	180	240	60	60	25	15	41,88	87,96	6	
50	M20	5	240	320	80	80	30	20	65,28	126,54	6	
30	M12	3	150	250	50	50	20	10	34,56	71,52	8	
40	M16	5	180	300	60	60	25	15	55,84	117,28	8	
50	M20	5	240	400	80	80	30	20	87,04	168,72	8	
30	M12	3	150	300	50	50	20	10	43,20	89,40	10	
40	M16	5	180	360	60	60	25	15	69,80	146,60	10	
50	M20	5	240	480	80	80	30	20	108,80	210,90	10	
30	M12	3	150	350	50	50	20	10	51,84	107,28	12	
40	M16	5	180	420	60	60	25	15	83,76	175,92	12	
50	M20	5	240	560	80	80	30	20	130,56	253,08	12	
30	M12	3	150	400	50	50	20	10	60,48	125,16	14	
40	M16	5	180	480	60	60	25	15	97,72	205,24	14	
50	M20	5	240	640	80	80	30	20	152,32	295,26	14	
30	M12	3	150	450	50	50	20	10	69,12	143,04	16	
40	M16	5	180	540	60	60	25	15	111,68	234,56	16	
50	M20	5	240	720	80	80	30	20	174,08	337,44	16	

d_c is the diameter and the total height of the connector

a_g is the metric connection thread of the connector

v_c is the height of the integrated anti-twist system

Fully threaded screw, GoFix® FK IF 30 5,0 x 40 mm - IF 40 6,0 x 60 mm - IF 50 8,0 x 90 mm

The connection is drawn together using a threaded rod or construction screw with a DIN 440 R washer

MB-SB connection as a mortise joint with simultaneous absorption of tensile forces

R_k characteristic value calculated according to DIN 1052:2004-08 Timber p_k 380 kg/m³ Nze. recommended permissible load $R_{k} \times 0,8$ k_{mod} : 1,3 γ_m : 1,4. Factor 1,4 average load safety factor

Please note: The stated values are planning aids. Projects must only be calculated by authorised persons.



SONOTEC SOUND INSULATION CORK

THE PERFECT SOLUTION FOR SOUND INSULATION

ADVANTAGES

- Sustainable material
- High load bearing capacity
- Hidden installation
- Easy to use
- Impermeable to water and gas due to component-specific requirements

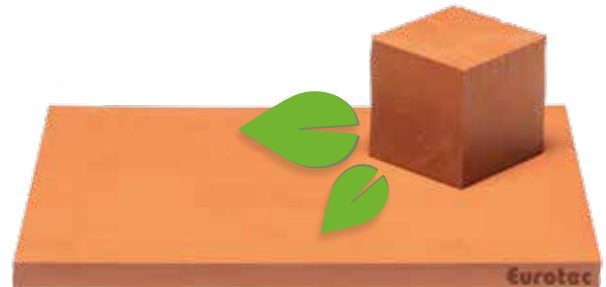

MATERIAL

The SonoTec sound insulation cork is a combination of the components cork and natural rubber. This product is suitable for the application of vibration damping where very high isolation values are required and can be used as invisible insulators (pads/strips) with a low resonant frequency and medium to low load.

LOAD ABSORPTION

Different loads have to be absorbed when decoupling the timber vertical truss from the concrete. These are located in the 0,1 N/mm² - 3 N/mm² stat. permanent load range. A timber beam (C24 softwood) may only be loaded up to 2,5 N/mm² (characteristic) perpendicular to the grain. Our products cover load cases from 0,1 N/mm² - 3 N/mm² ab. The cork can thus be used both in lightweight and solid construction with cross-laminated timber (CLT).

NOISE REDUCTION

The SonoTec sound insulation cork can reduce noise by up to 40 dB.



SonoTec sound insulation cork for separation and sound insulation on sill plate

SUSTAINABILITY

is important. Our SonoTec not only reduces sound, but also the use of plastics. Thus, it offers an environmentally friendly alternative to other sound reducers made of plastic. Without compromising on quality!

It consists of pure natural materials:
Cork and natural rubber.

In addition it is
THE PERFECT
SOLUTION FOR
SOUND INSULATION.



SONOTEC SOUND INSULATION CORK

THE PERFECT SOLUTION FOR SOUND INSULATION

SonoTec sound insulation cork

Material: SK02



Art. no.	Name	Dimensions [mm]	Material thickness [mm]	PU
945305	SK02	80 x 1100	6	20
945306	SK02	100 x 1100	6	20

SonoTec sound insulation cork

Material: SK03

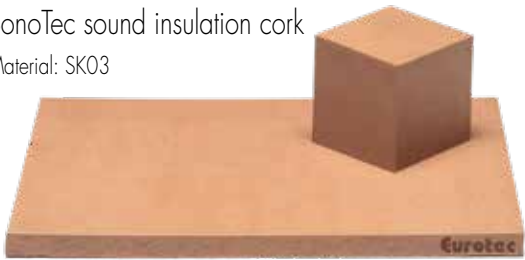

Art. no.	Name	Dimensions [mm]	Material thickness [mm]	PU
945307	SK03	80 x 1100	6	20
945308	SK03	100 x 1100	6	20

SonoTec sound insulation cork

Material: SK04



Art. no.	Name	Dimensions [mm]	Material thickness [mm]	PU
945309	SK04	80 x 1100	6	20
945310	SK04	100 x 1100	6	20

SONOTEC SOUND INSULATION CORK FOR VARIOUS APPLICATIONS

THE PERFECT SOLUTION FOR SOUND INSULATION

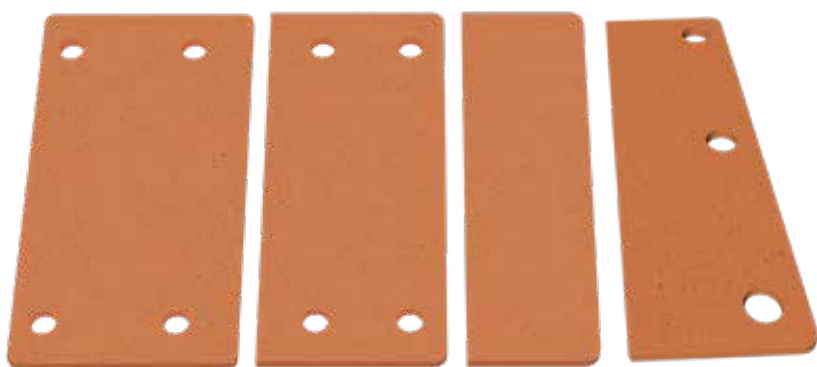

Different SonoTec decoupling profiles variations for shearing angles

Decoupling profile for the CLT system angle

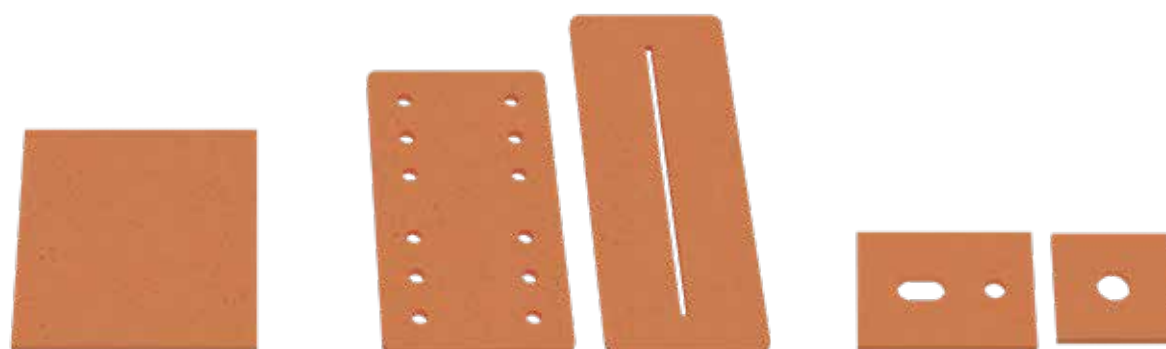

SonoTec for wooden support

SonoTec for invisible ground anchor

SonoTec for tension rods (left)
and tie bar simply (right)

Art. no.	Dimensions [mm]	Material	Can be combined with		PU
			Art-Nr.	Name	
945311	6 x 70 x 230	SK04	954088	HH flat shearing angle	5
945312	4 x 80 x 230	SK04	954180	CLT system angle	5
945314	6 x 100 x 230	SK04	954087	HB flat shearing angle	5
945313	6 x 120 x 230	SK04	954112	Shearing angle 120 x 230	5

TECHNICAL DATA

	SK02	SK03	SK04
	Load ranges [N/mm ²]		
Temperature [C°] / span width	10/+100	-10/+100	-10/+100
Density [kg/m ³]	700	1100	1125
Shore hardness [shore A]	35 - 50	45 - 60	60 - 80
Break rotatio [%]	> 200	> 300	> 100
Tensile strength [N/mm ²]	> 2,0	> 5,0	> 6,0
23°C / 70 h compression [%]	< 15	< 15	< 15

IDENTIFYING THE CORRECT MATERIAL: AN EXAMPLE

We precisely identify the right material for you. So you still get an idea of how the right material is identified, we have outlined a sample identification process for you below.

First of all, we need the static continuous load that the sound insulation cork is to absorb. This is specified by the architect, structural engineer or stress analyst in question.

One of three different materials is selected depending on the static continuous load:

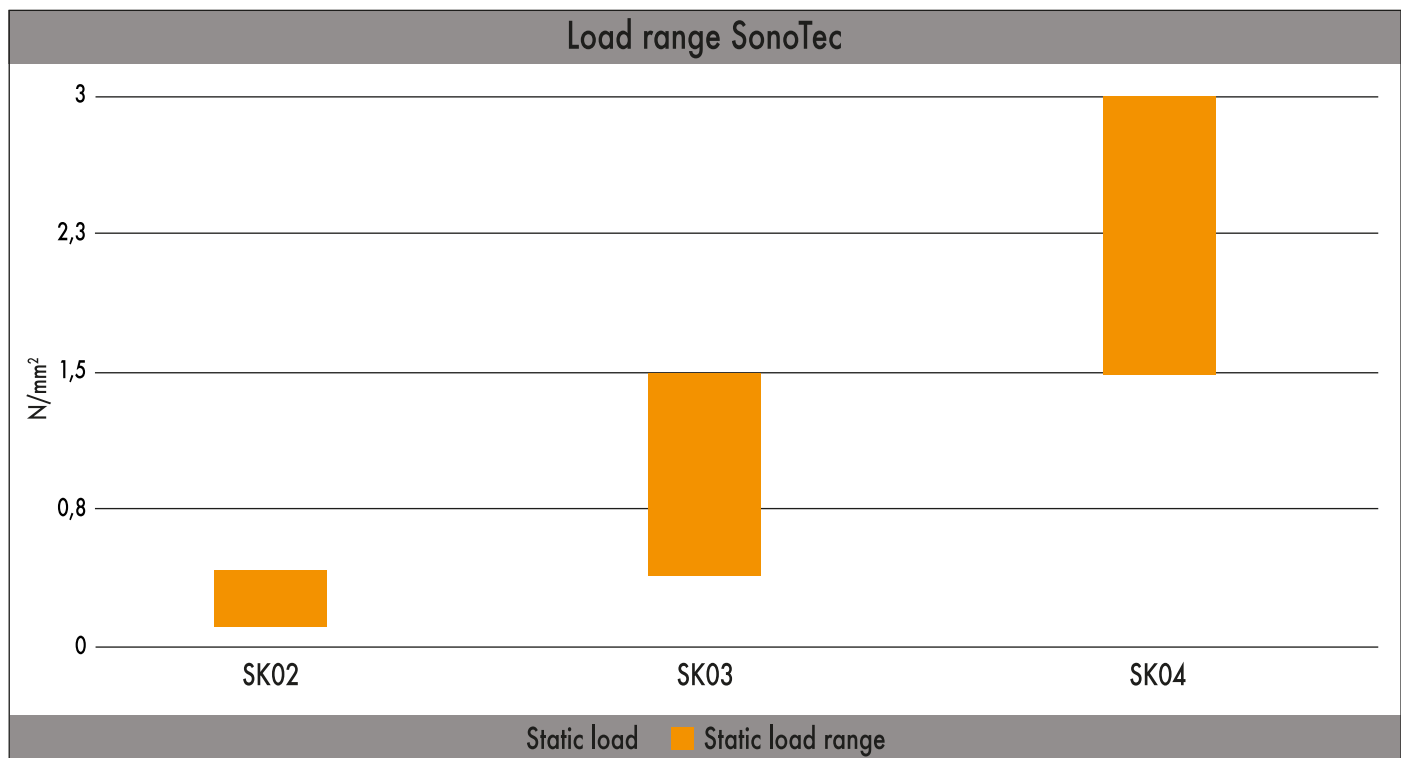

Please note: Verify the assumptions made. The stated values, and type and number of joining devices are based on preliminary measurements. Projects are to be dimensioned exclusively by authorised persons in accordance with the State Building Code. As per LBauO, please contact a qualified structural engineer for a paid proof of stability. We will be happy to refer you to someone.

Static continuous load N/mm ²	Product	Dimensions [mm]	Art. no.
0,10 - 0,39	SK02	80 x 1100	945305
0,10 - 0,39	SK02	100 x 1100	945306
0,40 - 1,40	SK03	80 x 1100	945307
0,40 - 1,40	SK03	100 x 1100	945308
1,50 - 3,10	SK04	80 x 1100	945309
1,50 - 3,10	SK04	100 x 1100	945310

In the **second step**, the material's natural frequency is determined; this depends on the occurring load. The values are approximately taken from the following table.

	Load [N/mm ²]	6 mm			12 mm		
		Natural frequency [Hz]	Deflection [mm]	Modulus of elasticity @10 Hz	Natural frequency [Hz]	Deflection [mm]	Modulus of elasticity @10 Hz
SK02	0,1	44	0,2	4,0	27	0,5	3,7
	0,2	33	0,5	4,5	19	1,3	4,0
	0,3	27	0,8	5,6	17	1,9	5,1
	0,4	27	1,1	6,9	17	2,6	6,5
SK03	0,5	50	0,2	11,5	31	0,4	10,5
	0,8	38	0,4	15,75	22	1,0	14,0
	1,1	31	0,7	19,5	20	1,6	18,0
	1,5	31	0,9	28,5	20	2,2	27,0
SK04	1,6	58	0,3	18,5	36	0,6	17,0
	2,4	44	0,6	24,5	25	1,3	22,0
	3,2	35	1,0	30,5	23	2,0	28,0
	4,0	35	1,5	43,0	23	2,7	41,0

*Values for SK02 are based on test results provided by the University of Coimbra / Institute for Research and Technological Development in Construction Sciences. The values for SK03 and SK04 are generalised. The ongoing tests confirm the values. The results will replace the described values.

As an example, the following sample calculation assumes a load of 0,3 N/mm². Our **SK02** material was chosen due to the specified load. From the above table, we can see that the natural frequency must therefore be 27 Hz. We can illustrate this as follows in the graphs below.

SK02 Natural frequency [Hz]

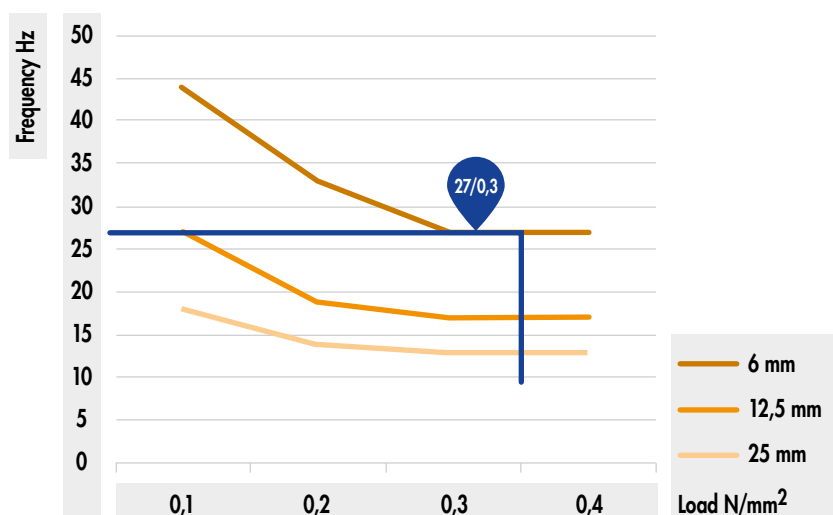

In the next step, we take a closer look at the interference frequency. To this end, we look at the graphs below and can thus conclude that the sound reduction in the low frequency range has deteriorated. Low frequencies (basses) can only be isolated by mass. The frequencies to be isolated for building acoustics start in the 80 Hz range, so this is negligible. 80 Hz can be assumed if no interference frequencies are specified.

The sound reduction in dB can be determined in two ways:

1:

Based on an interference frequency of 80 Hz, a sound reduction of approx. 17 dB can be read off the following graph. These values are achieved under ideal conditions (optimum room temperature, room humidity, etc.).

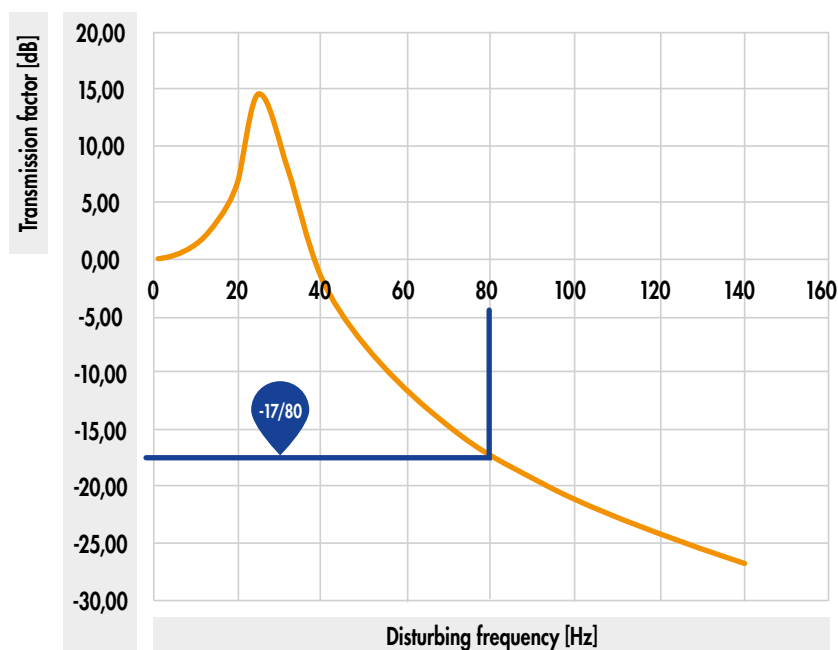

2:

A sound insulation factor can be calculated from the natural frequency identified previously (27 Hz) and the specified interference frequency (80 Hz).

Sound insulation factor f/f_0 : Interference frequency / natural frequency
 $\rightarrow 80 \text{ Hz} / 27 \text{ Hz} \approx 2,96$

The sound reduction can then be read off based on the factor calculated previously. This is 17 dB under ideal conditions.

Please note: Verify the assumptions made. The stated values, and type and number of joining devices are based on preliminary measurements. Projects are to be dimensioned exclusively by authorised persons in accordance with the State Building Code. As per LBauO, please contact a qualified structural engineer for a paid proof of stability. We will be happy to refer you to someone.

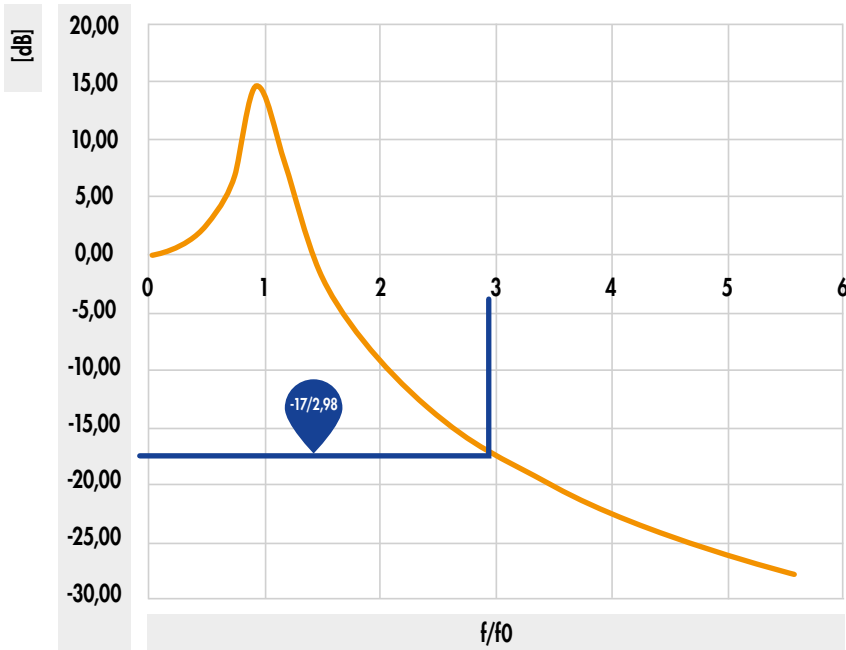

In the last step, the material's deflection is identified. This step is particularly important for the building's designers. The deflection is also identified using the continuous load, and there is a separate graph for each material. For the sample calculation with SK02 and $0,3 \text{ N/mm}^2$, the following graph shows a deflection of $0,8 \text{ mm}$.

The graphs shown here are naturally adapted to the factors identified previously.

SK02 Deflection [mm]

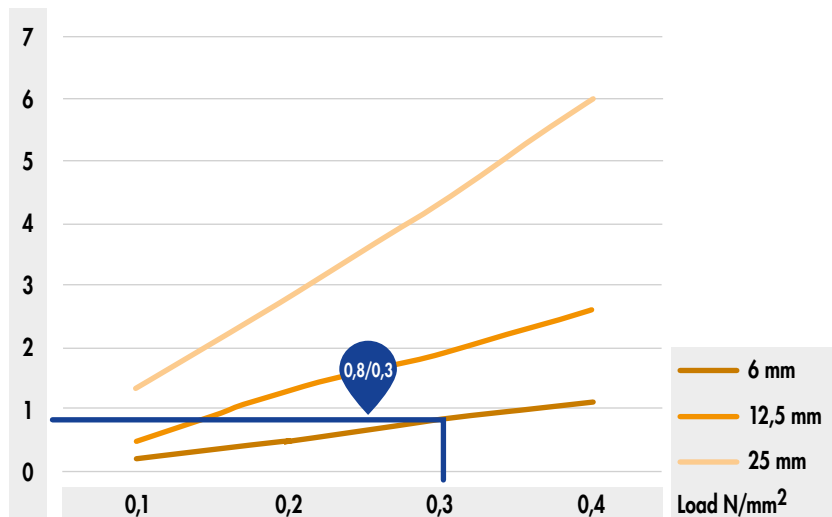

For our SK03 and SK04 materials, the following graphs apply to the deflection:

SK03 Deflection [mm]

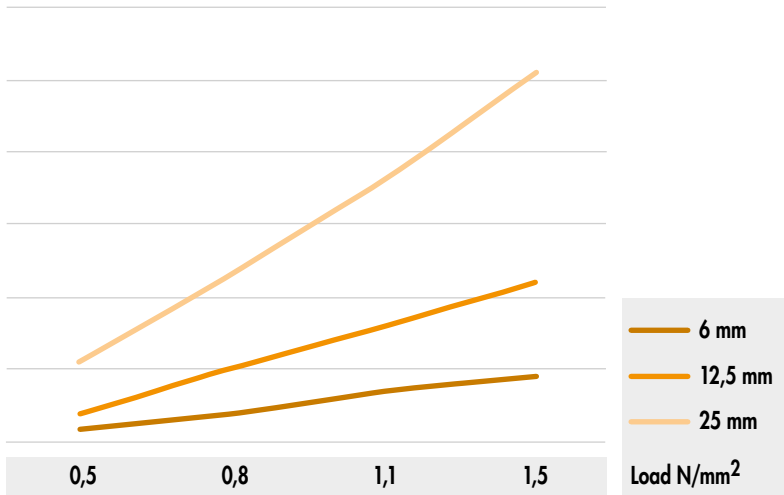

SK04 Deflection [mm]

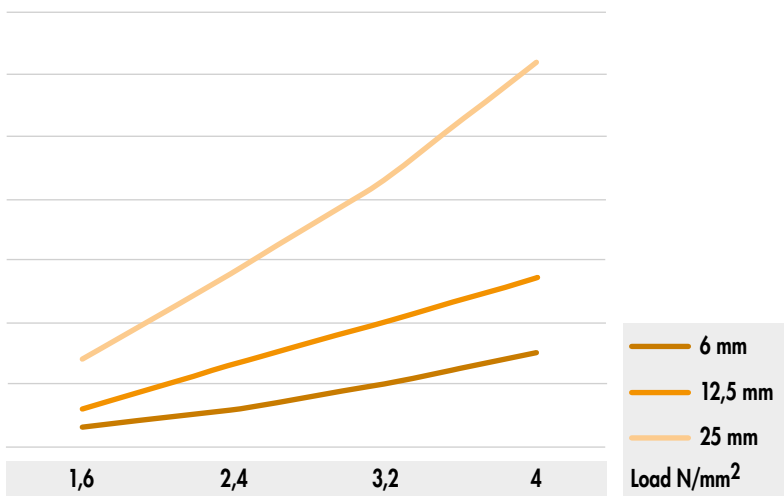

Please note: Verify the assumptions made. The stated values, and type and number of joining devices are based on preliminary measurements. Projects are to be dimensioned exclusively by authorised persons in accordance with the State Building Code. As per LBauO, please contact a qualified structural engineer for a paid proof of stability. We will be happy to refer you to someone.



© ab. fotoway - fotostockphoto.com

PROPERTIES OF CORK

The cork bark has a honeycomb-shaped cell structure with over 40 million cells per cm^3 . The cells have a high proportion of an air-like gas mixture, which results in the cork's low weight on the one hand and the high compression capacity and elasticity on the other. The cork can therefore be compressed by up to half its size and can return to its original shape after compression.

Almost half of the cork bark is made up of suberin, a non-combustible biopolymer. The substance lines the individual cells and makes them impermeable to liquids and gases. The bark's structure and thickness protect the cork oak from heat, drying out and infections. This natural protective insulation makes cork oak an ideal insulating and sealing material for technical purposes.



ADVANTAGES

- Very good sound and thermal insulation
- Impermeable to liquids and gases
- Good resistance to fire and high temperatures
- High frictional resistance
- Compressible and elastic
- Good wear resistance
- Low weight – floats on water
- Hypoallergenic and anti-static – does not absorb dust
- High flexibility – comfortable and soft

ENVIRONMENT

Cork is one of the most natural and environmentally friendly raw materials in the world. Cork oak is also the only tree that can completely regenerate itself after each harvest. The fact that cork can be recycled and reused in new products makes it an ideal raw material with regard to sustainability.

NATURAL RUBBER

Alongside cork, natural rubber is another natural and renewable raw material. Natural rubber is a rubber-like substance and is extracted from the milky sap (also known as latex) of the rubber tree. The rubber tree grows in the tropics of Africa, South America and Asia. Natural rubber accounts for around 40% of global rubber production. In contrast, synthetic rubber is made using crude oil as a basis and consumes far more energy during the manufacturing and transport processes.

Natural rubber is made into various products, most of them are used in tyre production. Other applications include seals, binders and mattresses.

PROPERTIES OF NATURAL RUBBER

- High level of elasticity
- Good mechanical resistance
- High tear strength
- Water repellent
- Poor electrical and thermal performance
- Weighs less than water



✪ If you would like further information, we would be delighted to send you our brochure. Alternatively, you will find out more online. ✪

SONOTEC ANGULAR DECOUPLER

PERFECT COMPLEMENT TO THE EUROTEC SHEARING ANGLES AND THE CLT SYSTEM ANGLE

ADVANTAGES

- Underlay enables straightforward assembly
- Sustainable material
- Invisible
- High load-bearing capacity
- REACH-compliant



DESCRIPTION

The Eurotec SonoTec Angular Decoupler forms the perfect complement to the Eurotec shearing angles and the CLT System Angle.

The underlay is made from SK04, which is a compound formed from cork and natural rubber. The product is suitable for vibration damping applications in which very high insulation values are required. SonoTec angular decouplers are used as invisible insulators (pads/strips) with a low resonance frequency and a medium-low load.

INSTRUCTIONS FOR USE

SonoTec angular decouplers feature cut-outs for concrete screws, making them suitable for use in concrete. The double layer allows an increase in the separation layer to 12 mm. The specifications for Sonotec SK04 Sound Insulation Cork apply. The material can be screwed through when used in wood. The application must be determined in advance by a structural engineer. No statement can be made regarding noise reduction since this is dependent on the construction.

Art. no.	Dimensions [mm]	Material	Can be combined with		PU
			Art. no.	Name	
945311	230 x 70 x 6	SK04	954088	HH flat shearing angle	5
945312	230 x 80 x 6	SK04	954180	CLT system angle	5
945314	230 x 100 x 6	SK04	954087	HB flat shearing angle	5
945313	230 x 120 x 6	SK04	954112	Shearing angle 120 x 230	5



Shearing angle for fixing a wall to the concrete foundation.

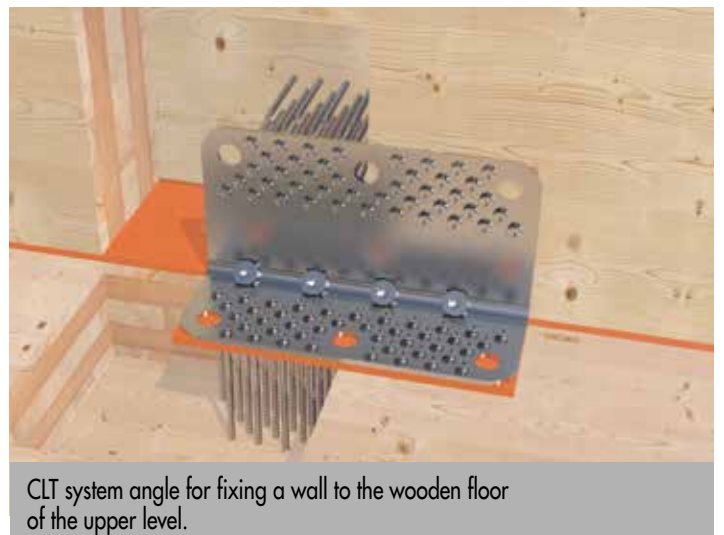

CLT system angle for fixing a wall to the wooden floor of the upper level.

BOLT ANCHOR FOR FASTENING IN CONCRETE



ADVANTAGES

- High load-bearing capacity
- Wide range of applications
- Fewer fastening points required due to spreader clip

INSTRUCTIONS FOR USE

The Eurotec Bolt anchor is a force-controlled expanding anchor for push-through installations. The galvanized steel bolt anchor is approved for use in non-cracked concrete, the stainless steel A4 bolt anchor for both non-cracked and cracked concrete. Despite the high load-bearing capacity, small axial and edge distances can be maintained. Different anchoring depths and dimensions allow a wide range of applications for connecting attachments of various materials to concrete. The A4 bolt anchor can be used both indoors and outdoors, while the galvanized steel bolt anchor can only be used indoors in dry conditions. Each Bolt anchor is equipped with an expansion clip, which ensures high load-bearing capacity and reduces the number of fastening points required.

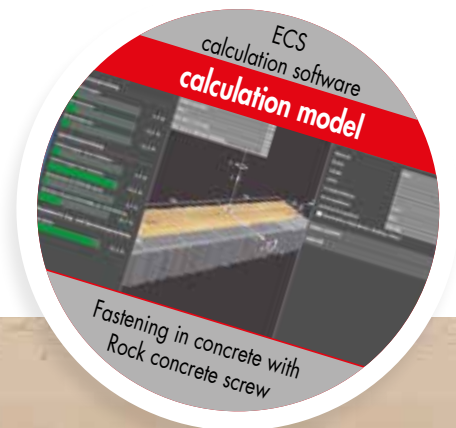

Bolt anchor for fastening the sill plate with the foundation

Bolt anchor A4

With washer, stainless steel A4,
for cracked concrete and non-cracked concrete



Art. no.	Dimensions [mm]	Spanner gap	PU
946142	8,0 x 75	SW13	100
946143	8,0 x 100	SW13	100
946144	10,0 x 100	SW17	50
946145	10,0 x 120	SW17	50
946146	10,0 x 140	SW17	50
946148	12,0 x 140	SW19	25

Bolt anchor

With washer, electrogalvanised, for
non-cracked concrete



Art. no.	Dimensions [mm]	Spanner gap	PU
946170*	6,0 x 55	SW10	200
946171*	6,0 x 85	SW10	100
946172*	8,0 x 50	SW13	100
946173	8,0 x 75	SW13	100
946174	8,0 x 95	SW13	100
946175	8,0 x 115	SW13	100
946176	8,0 x 135	SW13	50
946177*	10,0 x 60	SW17	100
946178	10,0 x 80	SW17	50
946179	10,0 x 100	SW17	50
946180	10,0 x 120	SW17	50
946181	10,0 x 140	SW17	50
946182*	12,0 x 80	SW19	50
946183	12,0 x 95	SW19	50
946184	12,0 x 110	SW19	50
946185	12,0 x 130	SW19	25
946186	12,0 x 160	SW19	25
946187	12,0 x 180	SW19	25
946188	16,0 x 125	SW24	20
946189	16,0 x 140	SW24	20
946190	16,0 x 180	SW24	10
nach DIN 440:			
946191	12,0 x 200	SW19	20
946192	12,0 x 220	SW19	20
946193	12,0 x 240	SW19	15
946194	12,0 x 260	SW19	15
946195	16,0 x 220	SW24	10
946196	16,0 x 240	SW24	10
946197	16,0 x 260	SW24	10

*Screws not regulated by ETA-14/0409

APPLICATION

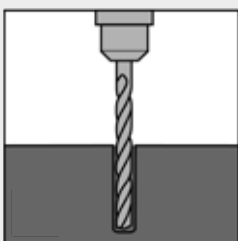

1 Create drill hole

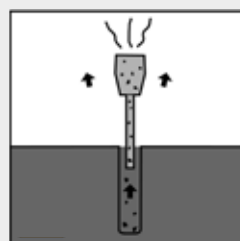

2 Clean drill hole thoroughly

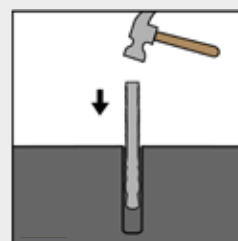

3 Drive in bolt anchor with a hammer

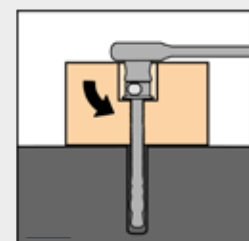

4 Screw on the hexagonal nut until the appropriate torque is reached

TECHNICAL INFORMATION

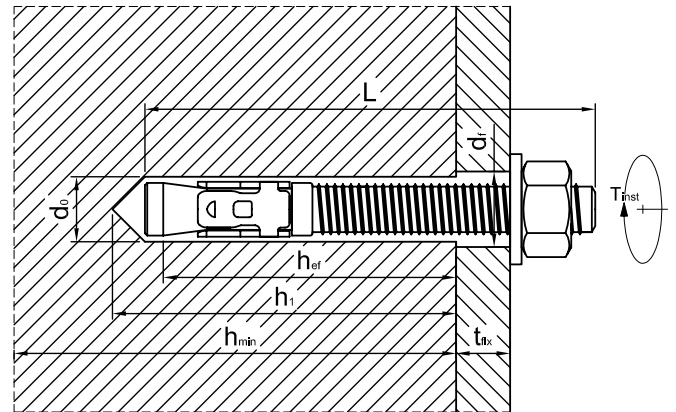

Dimensions [mm]	Min. Subsurface thickness h_{min} [mm]	Drill diameter d_o [mm]	Min. Depth of drill hole h_1 [mm]	Min. Depth of drill hole h_{ef} [mm]	Max. Drill diameter in attached part d_f [mm]	Max. attachment thickness t_{fix} [mm]	Installation torque T_{inst} [Nm]
$\emptyset \times$ Length							
Bolt anchor with washer according to DIN 125A							
6,0 x 55 *	100	6	50	35	7	5	11
6,0 x 85 *	100	6	50	35	7	35	11
8,0 x 50 *	100	8	55	30	9	5	15
8,0 x 75	100	8	55	40	9	15	15
8,0 x 95	100	8	55	40	9	35	15
8,0 x 115	100	8	55	40	9	55	15
8,0 x 135	100	8	55	40	9	75	15
10,0 x 60 *	100	10	65	30	12	5	25
10,0 x 80	100	10	65	50	12	5	25
10,0 x 100	100	10	65	50	12	25	25
10,0 x 120	100	10	65	50	12	45	25
10,0 x 140	100	10	65	50	12	65	25
12,0 x 80 *	110	12	80	50	14	5	40
12,0 x 95	110	12	80	65	14	5	40
12,0 x 110	110	12	80	65	14	20	40
12,0 x 130	110	12	80	65	14	40	40
12,0 x 160	110	12	80	65	14	70	40
12,0 x 180	110	12	80	65	14	90	40
16,0 x 125	120	16	90	80	18	15	80
16,0 x 140	120	16	90	80	18	30	80
16,0 x 180	120	16	90	80	18	70	80
Bolt anchor with washer according to DIN 440							
12,0 x 200	110	12	80	65	14	110	40
12,0 x 220	110	12	80	65	14	130	40
12,0 x 240	110	12	80	65	14	150	40
12,0 x 260	110	12	80	65	14	170	40
16,0 x 220	120	16	90	80	18	110	80
16,0 x 240	120	16	90	80	18	130	80
16,0 x 260	120	16	90	80	18	150	80
Bolt anchor A4							
8,0 x 75	100	8	60	45	9	15	20
8,0 x 100	100	8	60	45	9	40	20
10,0 x 100	120	10	75	60	12	25	45
10,0 x 120	120	10	75	60	12	45	45
10,0 x 140	120	10	75	60	12	65	45
12,0 x 140	140	12	85	70	14	50	60

* Not regulated by ETA-14/0409

ECS Bemessungssoftware 2.0 - Dübelbemessung - unbenannt

Datei Start Bemessung

Mehrfachbemessung Druckvorschau Zulassung / Bewertung Dokumente Artikel

Ergebnis Dokumente

Nachweise

BZ 12,0 x 160 mm

Zugbeanspruchung

Stahlversagen

Herausziehen	9,4 %
Betonausbruch	15,0 %
Betonausbruch	11,3 %

Querbeanspruchung

Stahlversagen ohne Hebelarm	9,9 %
Stahlversagen mit Hebelarm	94,8 %
Betonausbruch (Dübelgruppe)	5,7 %
Beanspruchung rechtwinklig zur Achsrichtung	30,7 %

Kombinierte Zug- und Querbeanspruchung

Interaktion	91,5 %
-------------	--------

VERANKERUNGSGRUND

ANBAUTEIL

Material	Holz
Breite	120 mm
Länge	1000 mm
Dicke	60 mm
Festigkeitsklasse	C24
Nutzungsklasse	NK1
Lasteinwirkungsdauer	Ständig
<input type="checkbox"/> Konstruktive Maßnahmen (Bulldog-Anker)	

DÜBELGRUPPE

LASTEN

Längen in [mm] | Kräfte in [kN] | Momente in [kNm]

✓ β_N : 15,0 % ✓ β_V : 94,8 % ✓ β_{NV} : 91,5 %



ECS SOFTWARE



Do you already know the ECS calculation program? Here you can easily calculate all necessary information for your specific construction site. Of course, this also works with our other products.

Download now www.eurotec.team/service



SILENT EPDM DECOUPLING PROFILE

FOR SOUND INSULATION AND MATERIAL SEPARATION

ADVANTAGES

- Versatile applications
- Can be individually cut to size (supplied as a roll)
- Ageing-resistant
- UV-stable
- Ozone-resistant
- Free of conflict materials

PROPERTIES

- Density: approx. 1,4 g/cm³
- Usage temperature: -30 °C - + 90 °C
- Shore hardness 48 = 0,500 N/mm² = 0,05 kN/m²

INSTRUCTIONS FOR USE

Cut the decoupling profile to the desired length and place it in the chosen position, then fasten it in place at intervals of approx. 40 – 60 cm, for example using the Eurotec Hammer tacker.



Silent EPDM decoupling profile between two wood elements



Silent EPDM decoupling profile reel material

Art. no.	Name	Thickness [mm]	Width [mm]	Lenght [mm]	Color	Material	PU
945382	Silent EPDM decoupling profile	5	95	20	Black	EPDM	1

Material properties

Property	Measurement method	Unit	Value
Hardness	DIN ISO 7619-1	Shore A	48
Density	DIN 53479	g/cm ³	1,23
Tear strength	DIN 53504	MPa	8,5
Elongation at break	DIN 53504	%	510
Compression set	DIN ISO 815-1	%	≤ 40
Temperature resistance		°C	-30/100 °C

Please note: Verify the assumptions made. The stated values, and type and number of joining devices are based on preliminary measurements. Projects are to be dimensioned exclusively by authorised persons in accordance with the State Building Code. As per LBauO, please contact a qualified structural engineer for a paid proof of stability. We will be happy to refer you to someone.



Application of the Silent EPDM decoupling profile under beams for sound insulation between wooden components.



Silent EPDM decoupling profile for material separation and sound insulation.

ECKTEC

THE SPACE-SAVING ALTERNATIVE TO THE CONVENTIONAL BRACE

ADVANTAGES

- Supports load absorption with horizontal forces
- Pre-assembly at the factory optional
- Many different areas of use

DESCRIPTION

The EckTec connector can replace the conventional brace. This allows a better look without disruptive braces, especially at low installation heights.

INSTRUCTIONS FOR USE

The EckTec connector is fixed with two 4 x 40 Paneltwistecs. The first KonstruX ST 8 x 155 fully-threaded screws are then set at 25° in the posts. After mounting the cross beam, the other 8 x 95 KonstruX ST fully threaded screws can be set at 90°. Min. cross-section of beam: 120 x 120 mm.

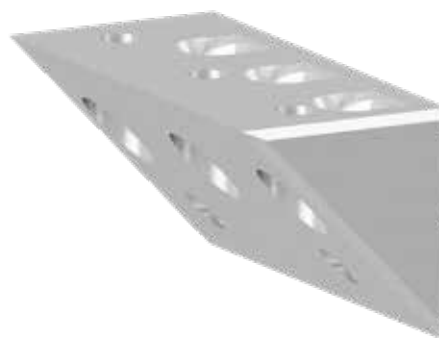

Art. no.	Dimensions [mm] ^{a)}	PU*
975664	50 x 50 x 100	1

a) Width x Height x Depth
*Delivery incl. screws

Load capacities EckTec 100 Timber - C24, $\rho_k = 350 \text{ kg/m}^3$; $k_{mod} = 1,0$	$M_{1,Rd}$ [kNm]	$F_{1,Rd}$ [kN]
Torque	1,39	-
Torque and traction (combined)	0,96	8,4

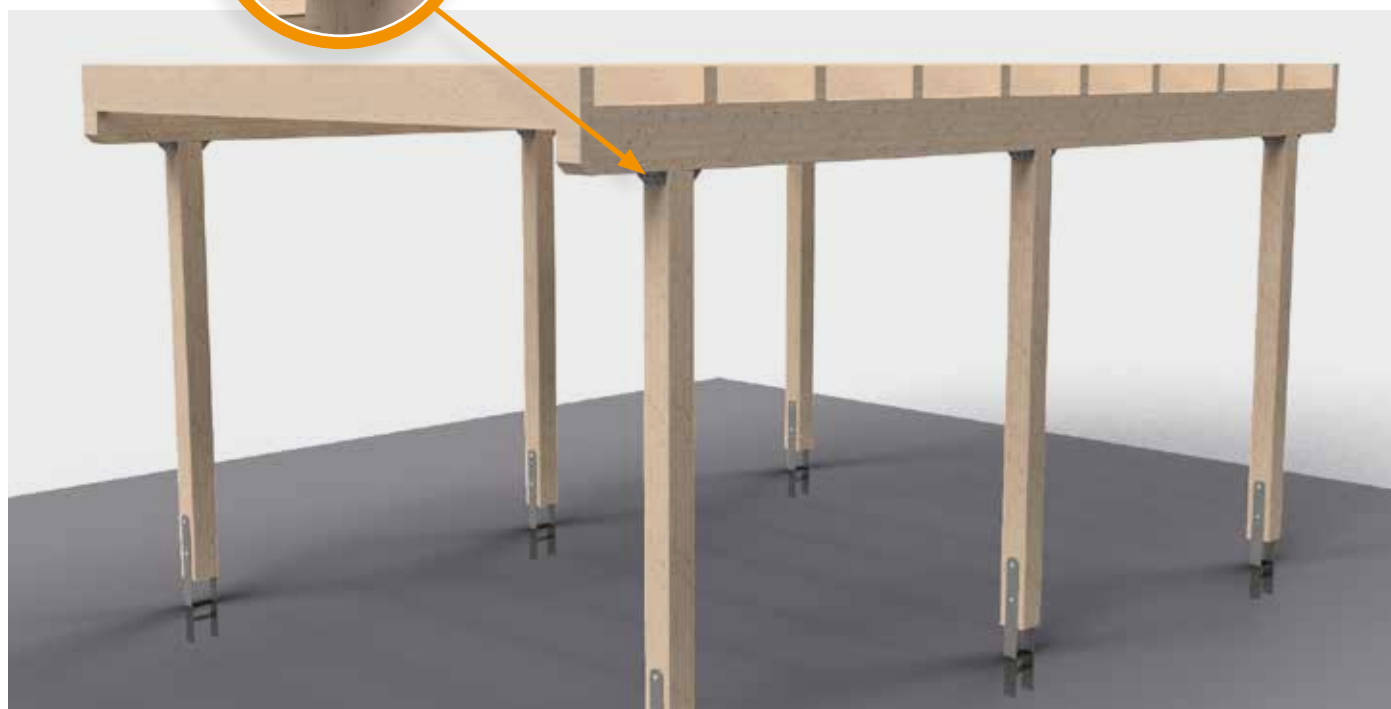



INDIVIDUAL SOLUTIONS FOR COMPLEX CONSTRUCTIONS

Your construction site is a bit more complex and you are missing the perfect connector for special tasks? **No problem!**

On request, we manufacture individual components, adapted to your needs, so that you can build worry-free!

Due to the ever-increasing popularity of wood as a building material in terms of environmental protection and cross laminated timber explicitly in building construction, we have increasingly focused on the topic of fastening and anchoring of prefabricated timber elements.

In this context, the efficiency as well as the quality of the products from the complex field of timber engineering is in the foreground. The core of this demanding architecture consists of complicated shapes, enormous spans of the structures as well as high static challenges. For our customers we are able to develop and manufacture unique solutions in these areas of modular construction. These include hall structures for industry, trade and agriculture; but also bridges or more complex roof structures.

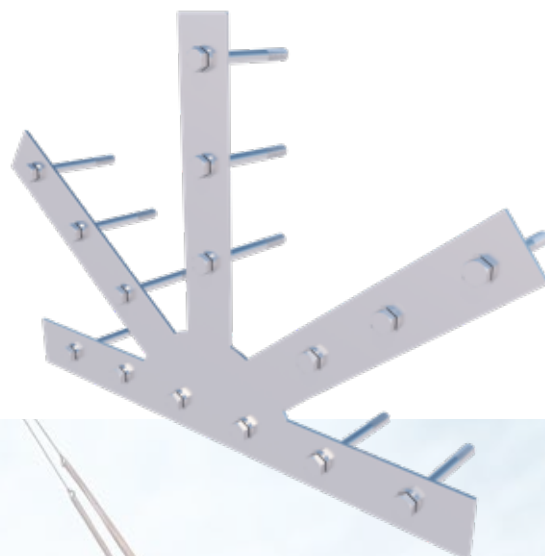

SPECIAL ELEMENTS

We offer customized solutions for your projects. From floor anchor plates with cross bracing in heavy timber construction connected by steel cables to cross flat connectors for heavily loaded timber connections with individual hole patterns.

- Optimal load distribution thanks to individual adaptations to your projects
- Better utilization of the individual connectors, for highly stressed junctions in engineered timber construction

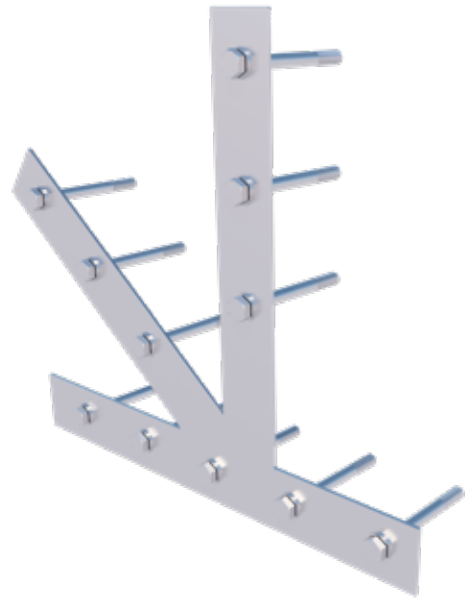

EUROTEC MODULE CONNECTORS

Our new products include shearing angles, shearing plates, tie rods and tension straps. These are used for anchoring walls, columns and ceilings.

The special features of shearing angles are the different installation heights and the type of perforation, depending on the application.

In order to secure aligned components against shear forces, we also developed the shearing plate, which can be used in a variety of ways to cover all possible anchoring cases.

In our product range you will find several variants of the tension straps. They can be used to create timber-timber, timber-concrete and steel-steel connections. Special holes for bolting at an angle of 45° make the tension straps particularly efficient and unique.

The Eurotec tie bar is used to absorb tensile forces to enable simple and fast base point anchoring of timber elements in timber, steel or concrete substrates.



✱ ALWAYS THE ✱
RIGHT
SOLUTION
✱ AT HAND! ✱

CONDITIONS OF SALE AND DELIVERY

All sales to buyers, customers and contract partners, hereinafter referred to as customers, are made exclusively subject to the following terms and conditions unless other agreements are made in writing in the individual case:

1. SCOPE, GENERAL PROVISIONS

Our terms and conditions shall apply exclusively! We will not accept contradictory terms and conditions of our customers that deviate from our conditions unless we have given our express written consent to their validity. Our terms and conditions shall apply even if we execute orders without reservation despite being aware of contradictory conditions or conditions that deviate from our terms and conditions. Our terms and conditions shall also apply to all future transactions with our customers. Customers can access the latest version of these Standard Terms and Conditions at www.eurotec.team at any time.

2. OFFERS, WRITTEN FORM

Our offers are non-binding and subject to alteration without notice until we issue our final order confirmation. Contracts and agreements, as well as transactions brokered by our representatives, shall become binding only when we issue our written order confirmation. Verbal agreements, even within the framework of contract execution, are not valid unless confirmed by us in writing.

3. PRICES, PACKAGING, OFFSETTING

Unless otherwise indicated by the order confirmation, our prices are ex-works and exclusive of packaging. This is billed separately. The minimum order value is €50.00. For smaller quantities, we charge a flat processing fee of €30.00.

- a) Our prices are exclusive of statutory value added tax. This is stated and charged separately in the invoice at the statutory rate applicable on the date of billing.
- b) Our customer may only claim a right of offsetting insofar as counterclaims are established to be legally binding or are undisputed or accepted. A right of retention may only be exercised with respect to counterclaims resulting from the same contractual relationship.

4. DELIVERY, DELIVERY PERIOD AND FORCE MAJEURE

Unless otherwise agreed in writing, the place of performance shall be our company premises. The goods are shipped at the customer's risk and expense by third parties acting on our behalf. From the time at which the goods are made ready for delivery and the customer has been informed of their readiness for shipping, the customer shall bear the risk of accidental loss or deterioration of the item. This shall apply even if shipping is delayed as a result of circumstances for which we are not responsible. Punctual handing over of the goods to a shipping company requires that the order be placed on time by our customer. If the goods are handed over to the appointed shipping company punctually, we will not be liable for delayed delivery to the customer. This shall apply even if a delivery deadline was agreed with the customer, especially in the case of delivery to a construction site. The customer may be exempted from rush charges incurred in relation to this if there is a legal basis for deducting this surcharge from the forwarder's bill.

Statements relating to delivery periods are always to be seen only as approximate and non-binding. They shall begin on the date of our order confirmation but not before all of the order details are clarified in full. They refer to the time of consignment ex-works and shall be considered met when the goods are reported to be ready for dispatch. Without prejudice to our rights arising due to the customer's default, they shall be extended by the period for which the customer is in arrears to us with respect to their obligations arising from this or other orders.

Even if they arise at our suppliers, the following grounds are among those that shall release us from the obligation to adhere to the delivery period and shall entitle us to extend the delivery periods, to make partial deliveries or to wholly or partially withdraw from the part of the contract that is not yet fulfilled without becoming liable to pay damages as a result, unless we are guilty of intent or gross negligence: interruptions of operations and difficulties in delivery of any kind, e. g. shortages of machinery, goods, materials or fuels, or incidents of force majeure, e. g. export and import embargos, fires, strikes, lock-outs or new official measures that adversely affect production costs and shipping.

5. SHIPPING

Goods are shipped at the expense and risk of the customer even if prepaid delivery was agreed. Additional costs for express shipping shall always be borne by the customer. Freight costs paid by us are to be seen only as an advancement of freight charges on behalf of the customer. Additional freight costs for urgent and express parcels shall be borne by the customer, even if we have borne the transport costs on individual occasions. Goods reported as ready for shipping must be accepted immediately and will be charged as exworks. If the goods are to be shipped abroad or passed directly to third parties, they must be examined and accepted in our factory; otherwise, the goods shall be deemed to have been delivered in accordance with the contract to the exclusion of any complaints. The risk, including that of confiscation, shall be transferred to the customer when the goods are handed over to the forwarder or freight carrier and, at the latest, when they leave our facility. Return shipments always require prior consultation with our internal sales department. Goods that are free of defects are only taken back with our express consent. A credit note is then issued for the value of the goods with deduction of a 25% return fee per item or against a minimum fee of €50 for returning the goods to storage. Strictly no debit notes are accepted.

6. DESIGN AND PROPERTY RIGHTS

The customer shall bear sole responsibility and be liable for ensuring that the goods it orders do not violate third-party property rights. No verification is performed on our part in this respect. The customer shall indemnify us against injunctions or claims for damages by third parties. If an injunction is requested against us, the customer shall meet the legal costs and shall compensate us for the damages we have incurred.

7. ACCEPTANCE, QUANTITY TOLERANCES AND CALL-OFFS

For contracts with ongoing deliveries, the goods are to be accepted in monthly quantities that are as consistent as possible over the course of the contractual period. If a call-off is not made on time, we shall be entitled, after the expiry of a grace period that we have granted, to divide the order at our own discretion, withdraw from the part of the contract that has not yet been executed, or make a claim for damages due to non-performance. In the case of call-off orders, the call-offs must always be made within 12 calendar months. Over- or under-shipment by up to 10% of the order shall be permissible.

8.1 PAYMENT TERMS FOR INVOICES, RIGHT OF RETENTION

Invoices shall be payable with a 2% discount within 10 days of the invoice date or net within 30 days, regardless of when the goods are received and without prejudice to the right to make a complaint for defects. Payment by means of acceptance or customer's bill of exchange shall require special written agreement in advance. Discount charges will be charged in the case of payment by means of acceptance, which must have a term no longer than 3 months and be issued within 1 week of the invoice date. Credit notes for bills of exchange or cheques shall apply subject to receipt and regardless of the purchase price's earlier due date in the event of default by the customer. They shall be issued with the value at the date on which the equivalent amount will be available to us; the discount charges will be charged at the respective bank rate. In the event that the payment term is exceeded, interest and commissions

may be charged without prejudice to other rights at the respective bank rate for overdrafts but at a rate at least 5% above the respective discount rate of the Deutsche Bundesbank [German Federal Bank]. If the payment terms are not adhered to or we become aware of circumstances that, in our view, are sufficient to reduce the customer's credit worthiness, all of our claims shall become payable immediately regardless of the term of any bills of exchange that have been accepted or credited.

We shall then also be entitled to perform outstanding deliveries only in exchange for advance payment, to withdraw from the contract after a reasonable grace period, and to demand compensation for default. We may also prohibit the resale or processing of the delivered goods and demand their return or the transfer of indirect possession of the delivered goods at the customer's expense. The customer hereby already authorises us to enter its premises and confiscate the delivered goods in the above cases. We shall be entitled to the usual securities for our claims according to their nature and extent, even if they are subject to conditions or of limited duration. Offsetting or withholding payments as a result of any counterclaims or notifications of defects shall be prohibited, except where claims are undisputed or established to be legally binding.

8.2 TERMS OF PAYMENT FOR WEB-SHOP CUSTOMERS

Payment shall be made exclusively in advance. Once the order process in our online shop is complete, you will receive an email with the bank details for our business account. The invoiced amount must be transferred to our account within 7 days. We cannot carry out your order until the payment arrives.

9. RETENTION OF TITLE

Until all liabilities arising from the business relationship are paid in full and, in particular, until all bills of exchange and cheques, including finance bills, given as payment are cashed, the goods delivered by us shall remain our property and may be taken back by us at the customer's expense in the event of default in payment. Until this point, the customer shall not be entitled to pledge or assign the goods to third parties as a security; it may sell them on or process them only within the framework of its ongoing business transactions. The customer shall be obliged to inform us immediately of any seizure by third parties of the goods delivered subject to retention of title.

In the event of further processing, the customer shall not acquire ownership of the goods delivered by us as set out in section 950 of the German Civil Code (BGB), as any processing is carried out by the customer on our behalf.

Without prejudice to the rights of third-party suppliers, the newly created thing shall serve as security for us up to the amount of our total claims arising from the business relationship. It shall be kept safe for us by the customer and shall be regarded as goods for the purpose of these terms and conditions. If the item is intermixed or otherwise combined with other objects that do not belong to us, we shall acquire at least co-ownership of the new thing in proportion to the value of the contract item to that of other objects that have been processed with it. If the customer sells the goods delivered by us, regardless of their condition, it hereby already assigns to us all claims against its customers arising from sales, as well as all ancillary rights, until all of our claims arising from delivery of goods are paid in full. At our request, the customer shall be obliged to notify its downstream customers of the assignment and to hand over the information and documents we require in order to assert our rights against its downstream customers.

If the total value of the securities given to us exceeds our claims arising from delivery by more than 20%, we shall be obliged to retransfer securities to this extent at the customer's request. If the retention of title or assignment is invalid in the territory in which the goods are located, a security corresponding to the retention of title or assignment in this territory shall be deemed to be agreed. If the customer's cooperation is required in this process, it shall take all necessary measures to establish such rights.

10. NOTIFICATION OF DEFECTS, LIABILITY

Our customer shall be entitled to a warranty only if they have properly fulfilled their legal obligations under sections 377 and 378 of the German Commercial Code (HGB) with respect to the duties of examination and notification. If defects are present, we shall be entitled at our choice to either repair the defects or provide a replacement; if we are not prepared or not able to do so, and especially if repair/replacement is delayed beyond reasonable deadlines for reasons that we are responsible for, or if repair/replacement otherwise fails, our customer shall be entitled at its choice to withdraw from the contract or to demand a corresponding reduction in the price.

Unless otherwise stipulated below, further claims of the customer shall be excluded regardless of their legal basis. We shall not be liable for damage that did not occur to the delivered item itself. In particular, we shall not be liable for lost profit or other pecuniary losses of the customer. The above exemption from liability shall not apply if the damage is caused by intent or gross negligence; it shall also not apply if the customer asserts claims for damages for non-performance due to the lack of a warranted characteristic. If we breach an essential contractual duty through negligence, our duty of reimbursement for property damage or personal injury shall be restricted to the level of cover provided by our product liability insurance.

We are prepared to allow the customer to view our policy. The warranty period is 6 months calculated from the date of transfer of risk. This period is a limitation period. The period shall also apply to claims under sections 1 and 4 of the German Product Liability Act (ProdHaftG). Insofar as our liability is excluded or restricted, this shall also apply to the personal liability of our employees, workers, staff, representatives and agents. Goods that are subject to a complaint must not be sent back without obtaining our prior written consent, as otherwise we may refuse to accept them at the sender's expense. Goods that have been partially or wholly processed will not be taken back under any circumstances. The customer is obliged to make sure that the purchased product is suitable for the intended application using technical descriptions, where available, and based on their specialist knowledge and to familiarise themselves with the application of this product. If they are not familiar with the product's application, our company staff are available to provide advice. All information and advice from our staff is provided carefully and conscientiously. Under no circumstances does this information and advice replace the indispensable consultancy services of architects and specialist planning companies or the services they provide during construction. Only the authorised professional groups are entitled to provide these services.

11. PLACE OF PERFORMANCE AND JURISDICTION, MISCELLANEOUS

Our company's registered office shall be the place of performance for all obligations arising from this contract, including liabilities from cheques and bills of exchange. Provided our customer is a merchant, the place of jurisdiction for all disputes arising from the contractual relationship shall be, at our choice, the Local Court of Hagen.

Contracts with our customer shall be governed exclusively by German law to the exclusion of the UN Convention on Contracts for the International Sale of Goods of 11 April 1980. The language of the contract shall be German.

Hagen, 16. February 2018

E.u.r.o.Tec GmbH

Unter dem Hofe 5 - 58099 Hagen

Managing directors: Markus Rensburg, Gregor Mamy

Court of registration: Local Court of Registration number HRB 3817 VAT ID No.: DE 812674291

Tax number: 321/5770/0639

Tel. +49 2331 62 45-0 • Fax +49 2331 62 45-200 • email info@eurotec.team • www.eurotec.team

Eurotec®

The specialist for fastening technologie

**SO,
HOW CAN WE
HELP YOU?**

▶ IMAGE FILM



E.u.ro.Tec GmbH

Unter dem Hofe 5 - D-58099 Hagen

Tel. +49 2331 62 45-0

Fax +49 2331 62 45-200

E-Mail info@eurotec.team

www.eurotec.team/en