



The specialist for fastening technology

OUR   
**STRUCTURAL  
TIMBER DESIGN  
GUIDE**

**WOOD SCREWS**

**DESIGN TABLES AND  
APPLICATION EXAMPLES**



(© European Union, 2021)



# CONTENT

## FUNDAMENTALS OF EUROCODES

Structural analysis requirements for timber and wood-based structures	8
Partial safety factors for connections: $\gamma_M$	9
Load duration and service classes: $k_{mod}$	10–11

## MATERIALS AND COATINGS

Corrosivity Categories	11
Selecting the right screw material/coating	12
Installation recommendations for Eurotec Structural Wood Screws	13–16

## USE OF TABULATED VALUES

16–18

## CALCULATION OF TABULATED VALUES

19–21

## APPLICATION EXAMPLES

Timber-Timber connection: purlin to rafter	22–23
Timber-Timber connection: shear-tension screws	24–25
Timber-Timber connection: joist to header	26–27
Timber-Timber connection: beam to post	28–29
Steel-Timber connection: shear-tension connection	30–31

## DESIGN TABLES

Konstrux fully threaded screws	32–81
Paneltwistec partially threaded screws	82–122
SawTec partially threaded screw	123–133
Topduo double threaded screw	134–136
Angle-bracket screw (ABS)	137–139
Anchor nails	140–142

# NEW MODULES IN OUR ECS SOFTWARE

Our ECS design software has undergone a major revision and enhancement. The focus has been on the integration of modules for timber construction. The aim is to provide the user with effective tools to prepare standardised connections quickly and verifiably.

For more information on the ECS software,  
simply scan the QR code

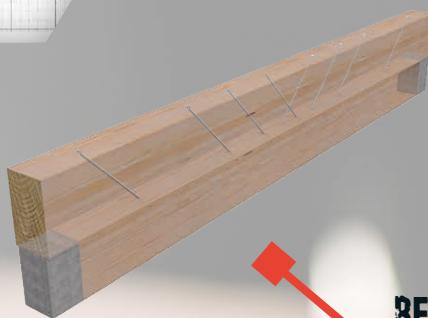
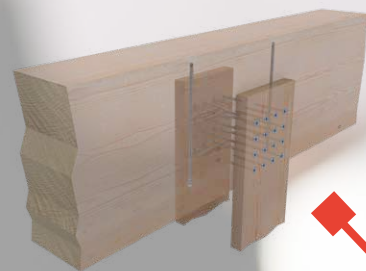

**BEAM DOUBLING**



**SUPPORT REINFORCEMENT**

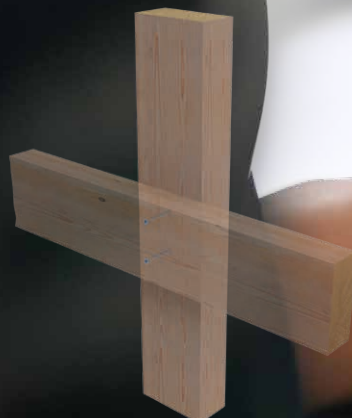

**CROSS CONNECTION**

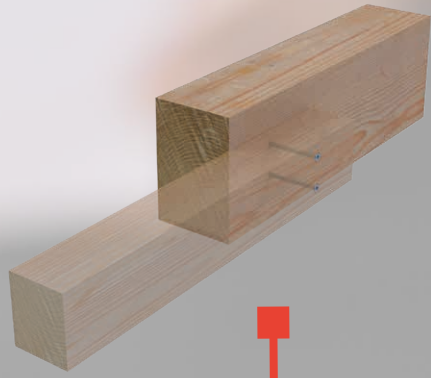

**LATERAL TAB JOINT**



**PARALLEL CONNECTION**

**MAIN SECONDARY BEAM CONNECTION**



# LEARN MORE ABOUT OUR ECS SOFTWARE

Eurotec Calculation Software (ECS) is a free, user-friendly pre-dimensioning program for Eurotec structural wood screws. Its modules include main-secondary beam connections, reinforcement of compression perpendicular to grain on supports, rafter-purlin connections, on-rafter/batten insulation fastening (wall or roof), among many others.

- The program allows you to **completely customize** your connection case, changing geometry and material type (glulam and timber, strength classes), magnitude of variable and permanent loads, service class, etc.
- Moreover, it **provides optimization of the fastening solution** by changing the diameter and length of screws and checking the strength-utilization ratio, which is presented in the bottom right corner of the screen.
- After adopting the connection solution, the **calculation report** in accordance with **ETA-11/0024** and **EN 1995 (Eurocode 5)** along with the corresponding drawings can be obtained in PDF format.

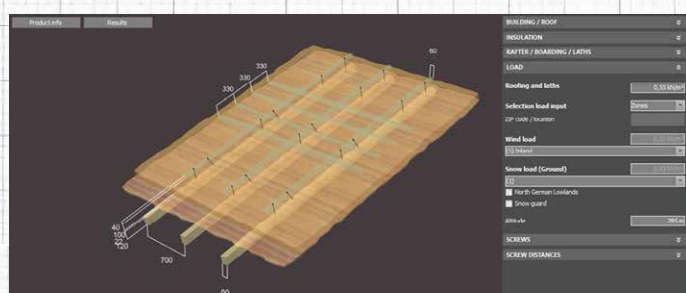
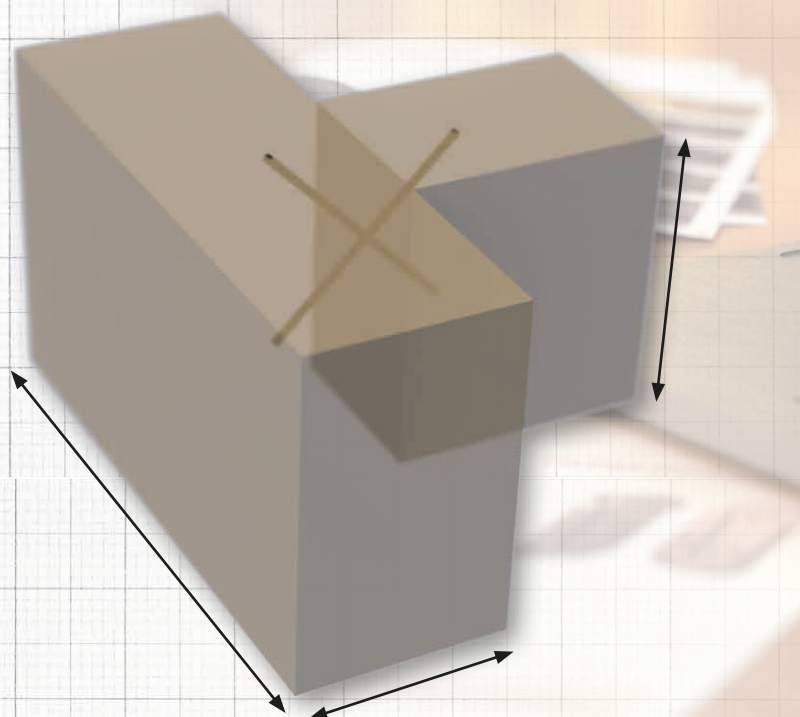
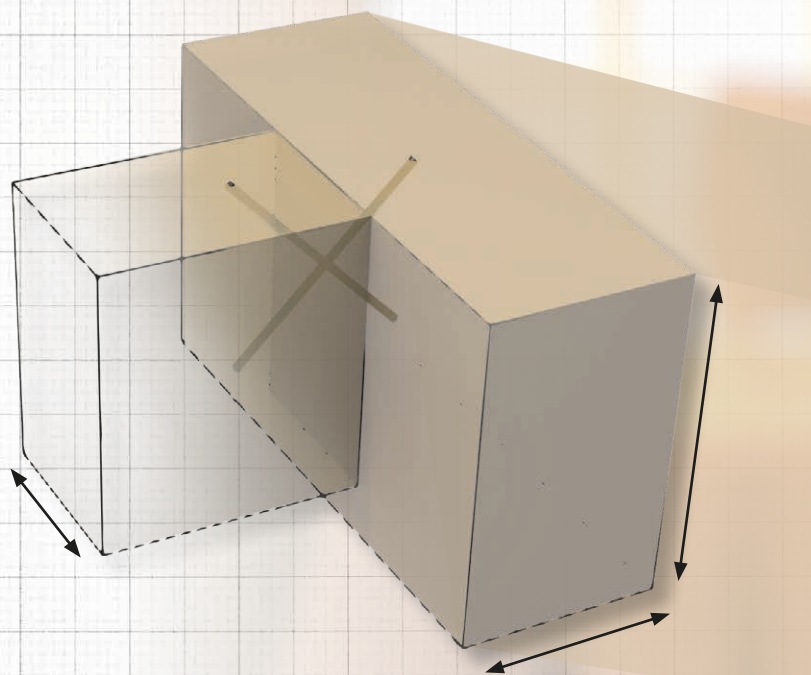

Rafter-purlin connection module, with Paneltwistec and KonstruX screws.

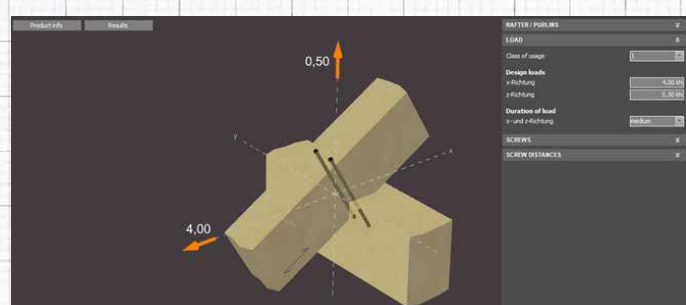

Modul für Sparren-Pfetten-Verbindungen mit Paneltwistec- und KonstruX

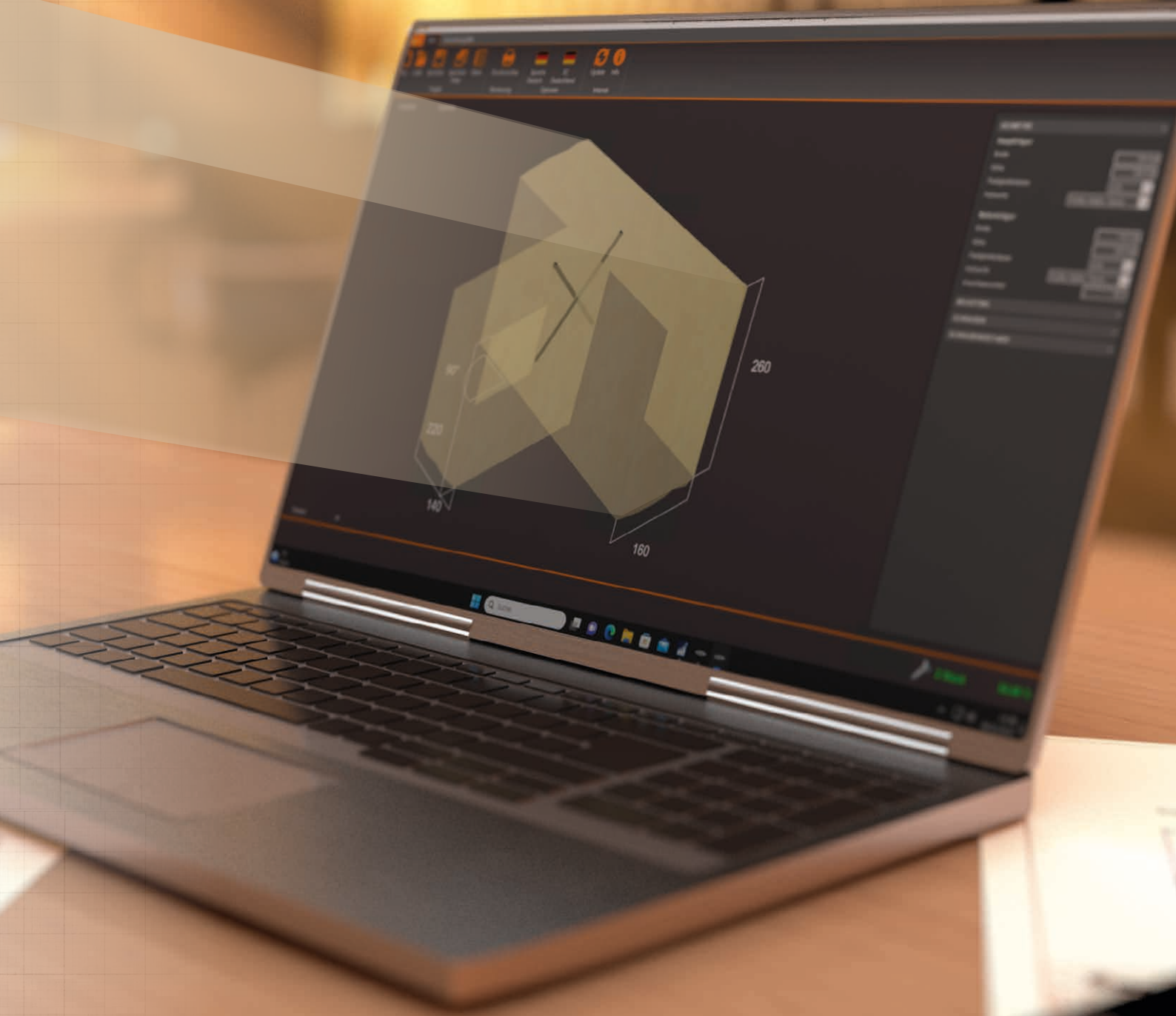

DISCOVER THE  
ECS SOFTWARE!

SCAN NOW



# FUNDAMENTALS OF EUROCODES

## STRUCTURAL ANALYSIS REQUIREMENTS FOR TIMBER AND WOOD-BASED STRUCTURES

### Verification by the partial factor method (EC0 6.1)

For most common designs, the partial factor design method is employed for the design of the structure and its components. In this method, the effect of an action is multiplied by a partial factor to obtain its design value ( $Ef_d$ ), and resistances, which are typically derived from material strengths, are divided by partial factors to obtain the design resistance ( $R_d$ ), at the Ultimate Limit State (ULS) and Serviceability Limit State (SLS). Next, verification is done at the relevant state to demonstrate that  $Ef_d$  is less than or equal to the design resistance ( $R_d$ ):

$$Ef_{d,ULS} \leq R_{d,ULS}; \quad Ef_{d,SLS} \leq R_{d,SLS}$$

The values used for actions and material properties are the characteristic or other standardized values, and the values for partial factors vary depending on the limit state being considered and must be such to achieve the level of reliability for the structure at that limit state according to EC0 2.2.

In this sense, having applied to the structure the design value of actions, the effects of actions are the response of the structure to those imposed actions, and comprise the internal stress resultants (such as shear and axial forces, moments) and the structural deformations (such as rotations and deflections). In Eurocode 5, the design value of the effect of the actions considered is:

$$Ef_d = Ef\{\gamma_{F,i} F_{rep,i}; \alpha_d\}$$

where, for each action "i",  $\gamma_{F,i}$  is a partial factor taking into account uncertainties in modelling the effects of actions and the possibility of unfavorable deviations of the action values from the representative values ( $F_{rep,i}$ ), and  $\alpha_d$  is the design value of geometrical data. When calculating the design value of a permanent action,  $\gamma_F$  is called as  $\gamma_G$ , and when calculating the design value of variable action, it is called as  $\gamma_Q$ .

Finally, the design value of a material property  $X_d$ , to be derived for the ULS or SLS, is defined as the characteristic value of the property ( $X_k$ ), multiplied by the mean value of a conversion factor ( $\eta$ ), and divided by a partial safety factor ( $\gamma_m$ ):

$$X_d = \eta \frac{X_k}{\gamma_m}$$

Taking that concept to the design resistance as defined in EC5 ( $F_{Rd}$ ),  $\eta$  is referred as the modification factor  $k_{mod}$ , considering the effects of duration of load and variation in moisture content on the properties of timber and wood products, and  $\gamma_m$  as  $\gamma_M$ , covering uncertainty in the resistance model used for design, together with the adverse effects of geometric deviations, in addition to the effect of unfavorable deviation of the material or product property. The analytical expression for this is:

$$F_{Rd} = k_{mod} \frac{F_{Rk}}{\gamma_M}$$

Therefore, the structure is considered to verify the ULS of Strength if the following expression is fulfilled:

$$Ef_d \leq F_{Rd}$$



## PARTIAL SAFETY FACTORS FOR CONNECTIONS

### Partial safety factors for connections: $\gamma_M$

Table 1 below (based on EC5 Table 2.3, German National Annex, and DIN EN 1993) shows the values of partial safety factors for metal fasteners and connectors according to the limit state considered. These partial safety factors cover uncertainty in the resistance model used for design, adverse effects of geometric deviations, and the effect of possible unfavorable deviation of representative material property.

Table 1: Partial safety factors for connections	
Limit state and material	$\gamma_{Mi}$
Ultimate limit states (fundamental combinations)	
Connections (excluding punched metal plate fasteners)	$\gamma_M = 1,3$
Resistance of members to instability assessed by member checks	$\gamma_{M1} = 1,0$
Resistance of cross-sections in tension to fracture	$\gamma_{M2} = 1,25$
Ultimate limit states (accidental combinations)	
Any material and connection	$\gamma_M = 1,0$
Serviceability limit states (all combinations)	
Any material and connection	$\gamma_M = 1,0$

## LOAD DURATION AND SERVICE CLASSES: $k_{MOD}$

### Load duration classes

Wood is a viscoelastic material, meaning that its structural behavior is time-dependent regarding the duration of the applied load. The longer a load is applied on wood, the more its strength properties will be reduced. In order to set a common criterion for design, load duration classes have been defined to cover the range of durations likely to occur in practice. The classes with their associated durations are shown in Table 2 (based on German NA to EC5). The “permanent” load-duration class comprises the action of self-weight, defined by a duration of more than 10 years, and actions that vary over time and are related to a duration of less than 10 years, are arranged into one of the remaining classes.

Table 2: Load-duration class definitions		
Class	Period of time	Examples of load type
Permanent	More than 10 years	Self-weight
Long term	6 months to 10 years	Storage loading, water tanks
Medium term	1 week to 6 months	Imposed floor loading, Snow (EASL > 1000 m)
Short term	Less than 1 week	Snow (EASL ≤ 1000 m), maintenance on roofs, residual structure after an accident event
Instantaneous	Less than 1 minute	Wind, explosion, impact loading

EASL: elevation of the building site above sea level

### Service classes

The strength, stiffness and rheological behavior of wood is severely affected by its moisture content. Since wood is a hygroscopic material, these properties are dependent on the service environment temperature and relative humidity conditions of the over the design life of the structure. This is addressed in EC5 by three service classes accounting for the typical environmental conditions that timber structures will serve. They are defined as follows:

- Service class 1: the service environmental conditions of surrounding air correspond to a temperature of 20 °C and the relative humidity only exceeding 65 % for a few weeks per year. This is where the average moisture content of most coniferous wood species will not exceed 12 %.
- Service class 2: the service environmental conditions of surrounding air correspond to a temperature of 20 °C and the relative humidity only exceeding 85 % for a few weeks per year. This is where the average moisture content of most coniferous wood species will not exceed 20 %.
- Service class 3: corresponding to surrounding air conditions leading to higher wood moisture contents than service class 2. This is where the average moisture content of most coniferous wood species will exceed 20 %.



Timber structural elements will show the highest mechanical properties in service class 1, and the lowest in service class 3. Table 3 (based on EC5 Table 3.1 and German NA) summarizes values of the modification factor  $k_{mod}$ , which adjusts wood's mechanical properties of solid timber and other wood-based materials accounting for load-duration class of action and service class of the component.

Table 3: Modification factor values  $k_{mod}$ 

Material	Standard	Service classes	Load-duration class of action				
			Permanent	Long term	Medium term	Short term	Instantaneous
Solid timber	EN 14081-1	1,2	0,60	0,70	0,80	0,90	1,10
		3	0,50	0,55	0,65	0,70	0,90
Glued-laminated timber	EN 14080	1,2	0,60	0,70	0,80	0,90	1,10
		3	0,50	0,55	0,65	0,70	0,90
Cross-laminated timber	EN 16351	1,2	0,60	0,70	0,80	0,90	1,10
Laminated veneer lumber	EN 14374 or EN 14279	1,2	0,60	0,70	0,80	0,90	1,10
		3	0,50	0,55	0,65	0,70	0,90
OSB	EN 300 OSB/2	1	0,30	0,45	0,65	0,85	1,10
	EN 300 OSB/3 OSB/4	1	0,40	0,50	0,70	0,90	1,10
	EN 300 OSB/3 OSB/4	2	0,30	0,40	0,55	0,70	0,90

## MATERIALS AND COATINGS

### CORROSIVITY CATEGORIES

DIN EN 1995-1-1 requires that metallic fasteners need to be either inherently corrosion-resistant or, if necessary, be appropriately protected against corrosion. Screws are made of a variety of steel types, later coated to achieve different degrees of corrosion resistance. Laboratory corrosion tests are carried out to measure the exposure resistance of materials and coatings to a highly corrosive environment. According to the measured exposed time without significant corrosion, the product with specific material and coating is assigned for use in certain environmental conditions. In addition to the aforementioned service classes, DIN EN ISO 12 12994-2 classifies environments into six categories of increasing corrosivity level: C1 to C4, C5-I, and C5-M.

Table 4: Corrosivity categories

Corrosivity category	Examples of typical outdoor environments	Examples of typical indoor environments
C1 Very low	–	Heated areas with dry air and minor amounts of impurities (e.g., offices, shops, schools, hotels)
C2 Low	Environments with low levels of atmospheric pollution. Rural areas.	Unheated areas with varying temperature and humidity levels. Low frequency of condensation and low level of atmospheric pollution, e.g., sports halls and warehouses.
C3 Moderate	Environments with low salinity or moderate atmospheric pollution. Urban areas and light Industrial areas. Areas with certain coastal influence.	Areas with moderate air humidity and some atmospheric pollution from production processes (e.g., breweries, dairies, laundries, etc.)
C4 High	Environments with moderate salinity or significant atmospheric pollution. Industrial and coastal areas	Areas with high humidity and high atmospheric pollution from production processes (e.g., chemical plants, swimming pools, shipyards, etc.)
C5-I Very high (industrial)	Industrial areas with high humidity and aggressive atmosphere.	Areas with almost constant condensation and high levels of atmospheric pollution.
C5-M Very high (maritime)	Coastal and offshore areas with high salinity.	Areas with constant condensation and high levels of atmospheric pollution.

## SELECTING THE RIGHT SCREW MATERIAL / COATING

### Step by step

Select the right screw material for your project by observing the following principles. Go through the three points one after the other. The right material is marked for points 1 and 2 with (X) at least, or even better with X. In the event of additional chemical stress, point 3 must conform as well.

1. What's the component's situation? Is it exposed to the weather (pergola beam) or is it protected (ceiling beam)?
2. Which wood is being fastened? Is it simple construction wood, or tannin-rich tropical wood?
3. Are there any additional stresses in situ that encourage corrosion? Location near the sea? Heavy industry, etc.?

#### Example: fastening a façade made of Douglas fir

1. Service class: 3, because of weather exposure. Aesthetic requirement also required → at least C1 steel.
2. Douglas fir → at least C1, but A2 or A4 steel is preferred.
3. This point is not required, because there are no further corrosive agents.

Choice: C1 is possible, but A2 or A4 is preferred.

Steel group	Hardened Carbon steel		Stainless steel (martensitic)	Stainless steel (austenitic)	
	Electroplated	Special coating	C1	A2	A4
Product examples	Panelwistec AG blue	Panelwistec 1000 Topduo	Panelwistec C1	Panelwistec A2	Panelwistec A4 Konstrux A4
<b>1. Location of the components?</b>					
Service class (SC) 1	X	X	X	X	X
Service class (SC) 2	X	X	X	X	X
Service class (SC) 3	-	(X) <sup>a)</sup>	X	X	X
<b>2. Which wood? <sup>c)</sup></b>					
Structural timber, wood-based materials <sup>b)</sup>	X	X	X	X	X
Beech (red beech)	X	X	X	X	X
Douglas fir	-	-	(X) <sup>a)</sup>	X	X
Spruce	X	X	X	X	X
Pine	X	X	X	X	X
Larch	-	-	(X) <sup>a)</sup>	X	X
Coniferous wood, pressure-impregnated	(X) <sup>a)</sup>	(X) <sup>a)</sup>	(X) <sup>a)</sup>	(X) <sup>a)</sup>	X
Red cedar	-	-	-	(X) <sup>d)</sup>	X
Fir	X	X	X	X	X
Coniferous wood, thermotreated	-	-	-	(X) <sup>d)</sup>	X
Abachi	-	-	-	(X) <sup>d)</sup>	X
Azobé, doussié	-	-	-	(X) <sup>d)</sup>	X
Azobé, bongossi	-	-	-	-	X
Bangkirai, balau	-	-	(X) <sup>c)</sup>	X	X
Bilinga	-	-	-	(X) <sup>d)</sup>	X
Courbaril, jatobá	-	-	-	-	X
Cumarú	-	-	-	(X) <sup>d)</sup>	X
Sweet chestnut	-	-	-	-	X
Oak	-	-	-	-	X
Eukalyptus	-	-	-	-	X
Garapa	-	-	-	-	X
Ipé	-	-	(X) <sup>c)</sup>	X	X
Iroko	-	-	(X) <sup>c)</sup>	X	X
Itaúba	-	-	-	-	X
Kasipo	-	-	-	-	X
Massaranduba	-	-	-	-	X
Merbau	-	-	-	-	X
Robinie	-	-	-	-	X
Hardwood, thermotreated	-	-	-	(X) <sup>d)</sup>	X
<b>3. Additional corrosive agents?</b>					
Constant condensation <sup>a)</sup>	-	-	-	(X) <sup>a)</sup>	X
Salt load <sup>f)</sup>	-	-	-	(X) <sup>a)</sup>	X
Aggressive atmospheres <sup>g)</sup>	-	-	-	-	(X) <sup>i)</sup>
Chlorous atmospheres <sup>h)</sup>	-	-	-	-	-

a) Recommended only for less significant fastening points, or for temporary objects, or if there are no aesthetic requirements.

b) Untreated: spruce, fir, pine, composite timber, KVH®, LVL, plywood, OSB, fiberboard, cement-based and gypsum fiberboard, etc.

c) In our experience, using this type of wood with C1 does not lead to problems with corrosion or timber discoloration. However, depending on the origin of the timber, this cannot be ruled out completely. Please also inquire at your timber dealer.

d) Use of A4 is recommended. Please contact your wood dealer as well.

e) Uninterrupted condensation in a water vapor atmosphere with only slight impurities.

f) Building components close to roads heavily affected by salting in winter, coastal areas, in offshore and other industrial conditions.

g) Building components in road tunnels, pig stalls, or in other aggressive atmospheres, possibly with additional higher air humidity.

h) Building components in indoor swimming pools or other chlorous atmospheres.

i) To be checked for each individual case.

**This overview cannot take account of all applications. Materials can be specified to more unfavorable conditions on a case-by-case basis.**

## INSTALLATION RECOMMENDATIONS FOR EUROTEC STRUCTURAL WOOD SCREWS

The quality of a timber connection depends not only on the quality of the fasteners used, but also on proper installation methods and equipment. For instance, material type of fastener, nominal diameter of fastener, length of fastener, and wood density have major influence. Eurotec provides recommendations on this matter, as well as the appropriate tools and accessories needed for achieving an accurate, safe, and efficient installation of a timber connection with fasteners.

### Accessories:

Installing Eurotec wood screws requires nothing more than the typical carpentry bits and accessories available on the market. Our complete range of screws features a TX-type head, which allows the right amount of tightness and torque transmission needed. A few points that the installer should consider when assembling his/her set of tools and accessories are:

- Drill bits and impact driver bits are different. There are adaptors for using them interchangeably, but it's better to avoid them to achieve the shortest force path.
- The size and type of accessory to use with your power tool depend on the type and diameter of the fastener to be installed. Please check **the Table 5** below for guidance.
- The materials of the bit/accessory and the fastener should match. For example, we recommend using our stainless-steel bits for installing our range of A2 and A4 stainless-steel screws. This measure prevents the risk of a stripped screw, galvanic corrosion from happening.
- A magnetic screw holder can be of great help for overhead installation of screws.

Table 5: Bit sizes for Eurotec screws

Screw type	Nominal diameter [mm]	Bit				
		TX20 ●	TX30 ●	TX40 ●	TX50 ●	E12 socket
KonstruX (fully threaded)	6,5	-	x	-	-	-
	8,0	-	-	x	-	-
	10,0	-	-	-	x	-
	11,3	-	-	-	x	-
	13,0	-	-	-	-	x
Paneltwistec (partially threaded)	6,0	-	x	-	-	-
	8,0	-	-	x	-	-
	10,0	-	-	-	x	-
SawTec (partially threaded)	6,0	-	x	-	-	-
	8,0	-	-	x	-	-
	10,0	-	-	-	x	-
Topduo (double threaded)	8,0	-	-	x	-	-
Angle-bracket screw	5,0	x	-	-	-	-



Discover our bits and aids range:



Magnetic screw holder



Short and long S2 steel bits (drill or Impact power tools)



Long carbon steel bits (drill)



Long stainless-steel bits (drill)

**Power tools:**

Eurotec wood screws can be installed with traditional drills and are also approved for use with tangential impact drivers (only carbon steel and stainless-steel C1 screws). This is possible due to the exceptional torsional strength to insertion moment ratio of the screws, otherwise, they shear-off during installation. The use of an impact driver has many advantages, like preventing screw cam out and being safer for the installer due to the isolation of the torque between the screw and the tool. In contrast, the drill doesn't have these benefits, but is rather faster for installing long screws of more than 300 mm without wobbling.



\* Only on timber-timber connections

**Preparation:**

In general, wood screws can be installed directly, without previously drilling a pilot hole (predrilling) to prevent wood splitting. In some cases, depending on factors like the length of the screw, wood species, and small edge and end distances, it might be beneficial to predrill prior to installation. For example, softwoods (particularly Douglas fir) or hardwoods with characteristic densities over 450 kg/m<sup>3</sup>, fasteners longer than 400 mm, and A2 and A4 stainless-steel screws are strongly recommended to be installed with predrilling. However, predrilling is mandatory for KonstruX A4 screws. See the Table 6 for guidance on the correct pilot hole diameter for each nominal diameter size of screw. Apart from avoiding wood cracking, predrilling decreases the installation torque, increases installation precision, and causes less wear on tools resulting in higher load-carrying capacities and reduced spacing and end distances. Moreover, predrilling is also recommended for screws with a length equal or greater than 600 mm up to a third of the screw length to assure the screw is maintaining its intended direction or angle.

*The use of lubricants to simplify installation is permitted under certain conditions. Since not all lubricants are suitable for every application, the type of lubricant must be selected appropriately depending on the type of the steel and the surface coating.*

Table 6: Pilot hole diameters for Eurotec screws	
Nominal diameter of screw [mm]	Maximum pilot hole diameter in softwood [mm]
6,0	4,0
6,5	4,0
8,0	5,0
10,0	6,0
11,3	8,0
13,0	9,0

**Installation:**

Follow this step-by-step process to correctly install Eurotec wood screws:



In any case, **do not hammer the screw's head** prior to installation. This causes prestress on the screw and could also damage the head and tip, possibly reducing installation precision and strength.

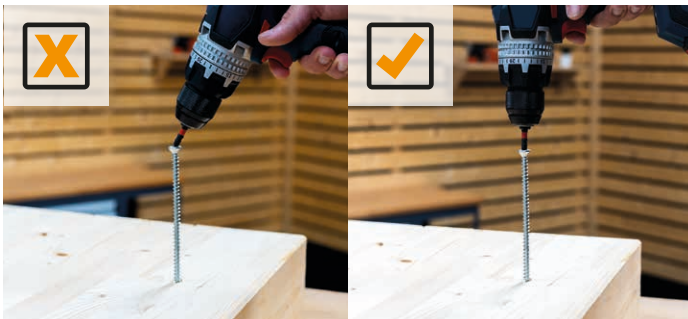

**Completely insert** the bit in the power tool and **fully tighten** it. Always ensure that the bit and the screw's body are **aligned** at the beginning and during installation to **avoid stripping the bit** and guarantee **proper torque transmission**. The bit must be fully inserted in the screw's head.



We recommend installing Eurotec wood screws in **one continuous run**. To stop and restart installation often increases the difficulty and may also **damage the screw's body** through the hot-cold transition zone.



During installation, **don't apply too much pressure**, as it may cause buckling on slender screws, not achieving the desired result.



When the fastener's head is **approximately 30 mm** away from the wood's surface, we recommend **slowing down** the installation speed. This prevents **over-torquing** the screw. In case of **steel-timber** connections, this is **especially important**.

**Finished look:**

Correct installation of wood screws not only gives an aesthetic finish to the connection, but also contributes to creating appropriate force transfer. When it comes to partially threaded screws, head pull-through capacity is often crucial. The screw's head diameter influences its resistance exponentially, therefore, to take full advantage of it, it is important that the bottom surface of the head completely rests on the wood or steel surface.

Countersunk head screws and SawTec's head feature milling ribs and sawteeth, respectively, and thus they are intended to end flush with the wood's surface. On the other hand, washer head screws are intended to rest on the surface of wood components. If concealed fastening is desired, we recommend using cylindrical head screws, which may be drilled beyond the wood's surface to completely hide the screw from sight.

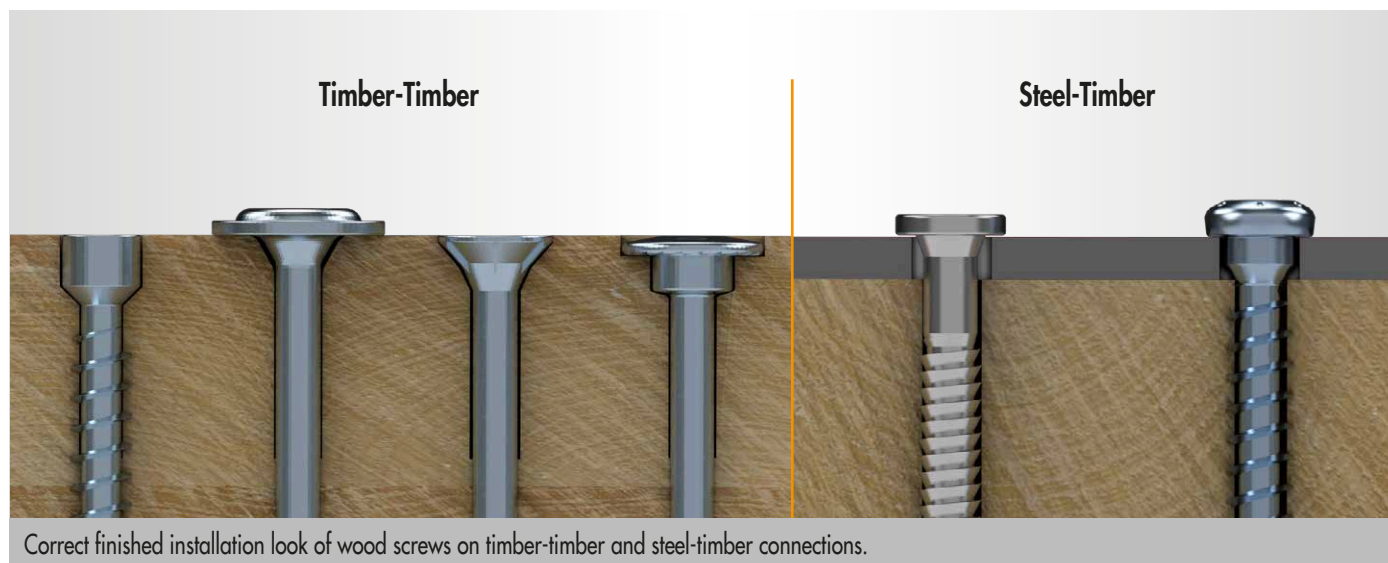

## USE OF TABULATED VALUES

**General conditions**

The tabulated values correspond to the load-carrying capacity per screw determined in accordance with ETA-11/0024 and EN 1995-1-1 for timber to timber and steel to timber connections with Eurotec wood screws without predrilling and considering timber members with a characteristic density of  $\rho_k = 380 \text{ kg/m}^3$  for KonstruX screws and  $\rho_k = 350 \text{ kg/m}^3$  for all other screws. Load-carrying capacities are specified as characteristic values and as design values for modification factor  $k_{mod} = 0,8$ , partial safety factors for connections on wood  $\gamma_M = 1,3$ , and  $\gamma_{M2} = 1,25$  for steel.

For modification factors other than  $k_{mod} = 0,8$ , the desired load-carrying capacity design value can be obtained from the tabulated characteristic one by multiplying it for the desired  $k_{mod}$  value and dividing it by  $\gamma_M = 1,3$ . Nevertheless, the tabulated design values can be safely used for all  $k_{mod} \geq 0,8$ .

**Timber-Timber and Steel-Timber connections**

The load-carrying capacity values presented correspond to the maximum capacity that can be achieved with a single screw for a particular diameter and a given minimum screw length. This load-carrying capacity is valid for this screw length or a longer one. For smaller component thicknesses than those presented in the tables, individual load-carrying capacity calculations can be done.

**Verification of the load-carrying capacity under combined loads**

Load-carrying capacity verification of a connection subjected to combined axial and lateral loads is calculated as per DIN EN 1995-1-1 (8.28):

$$\left(\frac{F_{ax,Ed}}{F_{ax,Rd}}\right)^2 + \left(\frac{F_{v,Ed}}{F_{v,Rd}}\right)^2 \leq 1$$



### Connections with multiple screws

For connections with several screws, the effective number of screws  $n_{ef}$  is calculated to account for the irregular load distribution on them, as show in Table 7. The effective load-carrying resistance of the screwed connection is then expressed as:

$$F_{ef,Rk} = n_{ef} \cdot F_{Rk}$$

Axially loaded screws (EN 1995-1-1, 8.7.2(8))

$$n_{ef} = n^{0,9}$$

Table 7: Effective number of screws  $n_{ef}$  for axially-loaded screws

$n$	2	3	4	5	6	7
$n_{ef}$	1,87	2,69	3,48	4,26	5,02	5,76

Laterally loaded screws (EN 1995-1-1, 8.3.1.1(8))

$n_{ef} = n$  If the screws are arranged in a row parallel to the grain direction, staggered (offset) by 1-d perpendicular to the grain direction.

See table below If the screws in a row parallel to the grain direction are not staggered or if the spacing between the screws in a tear line is less than 14-d. The value of  $n_{ef}$  is given in Table 8 as a function of  $a_1$  and  $n$ .

Table 8: Effective number of screws  $n_{ef}$  for laterally loaded screws not staggered

$n$	Spacing between screws in a row parallel to grain ( $a_1$ ) *									
	5-d	6-d	7-d	8-d	9-d	10-d	11-d	12-d	13-d	14-d
2	1,48	1,55	1,62	1,68	1,74	1,80	1,85	1,90	1,95	2,00
3	1,86	2,01	2,16	2,28	2,41	2,54	2,65	2,76	2,88	3,00
4	2,19	2,41	2,64	2,83	3,03	3,25	3,42	3,61	3,80	4,00
5	2,49	2,77	3,09	3,34	3,62	3,93	4,17	4,43	4,71	5,00

\* For intermediate values of  $a_1$ , a linear interpolation is allowed.

### In the case of screws:

- Used as reinforcement,
- Installed inclined to the grain direction in mechanically jointed beams or columns,
- Used for fastening thermal insulation material,

the effective number of screws can be considered as  $n_{ef} = n$ .

**Minimum spacings and edge distances of screws for shear and axial loads**

The minimum spacings below, as per EN 1995-1-1, apply for laterally loaded screws not predrilled in timber-timber connections, with nominal diameter above 5 mm, and for wood with a characteristic density up to 420 kg/m³. In the following formulas,  $\alpha$  is the angle between the force and wood grain direction.

$$\alpha_1 \geq (5 + 7 \cdot |\cos \alpha|) \cdot d$$

$$\alpha_2 \geq 5 \cdot d$$

$$\alpha_{3,t} \geq (10 + 5 \cdot \cos \alpha) \cdot d$$

$$\alpha_{3,c} \geq 10 \cdot d$$

$$\alpha_{4,t} \geq (5 + 5 \cdot \sin \alpha) \cdot d$$

$$\alpha_{4,c} \geq 5 \cdot d$$

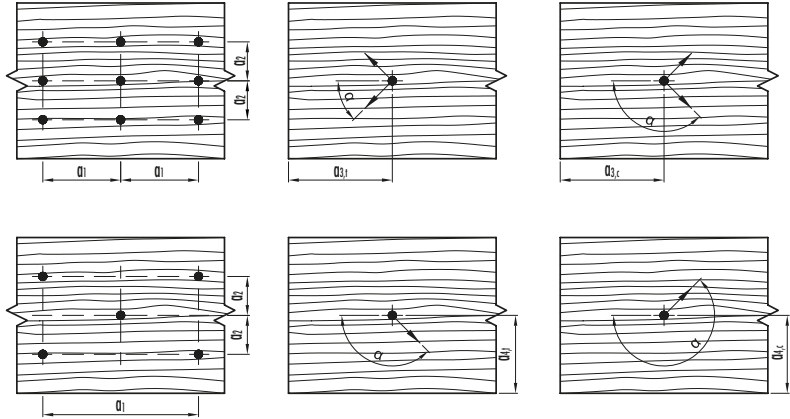

In steel-timber connections, the minimum spacings  $\alpha_1$  and  $\alpha_2$  may be reduced by a multiplying factor 0,7.

For exclusively axially loaded Eurotec screws in predrilled holes and for screws with drilling tip type (KonstruX ST), the following minimum spacings are valid in accordance with ETA-11/0024 considering a minimum member thickness  $t = 10 \cdot d$  and minimum width  $w = \max(8 \cdot d ; 60 \text{ mm})$ . The distance between cross screws shall be equal or greater than  $1,5 \cdot d$ .

$\alpha_1 \geq 5 \cdot d$	$\alpha_2 \geq 5 \cdot d$	$\alpha_{1,t} \geq 5 \cdot d$	$\alpha_{2,c} \geq 3 \cdot d$	$\alpha_1 \cdot \alpha_2 \geq 25 \cdot d^2$ *
---------------------------	---------------------------	-------------------------------	-------------------------------	---

\*If this condition is fulfilled, the spacing  $\alpha_2$  perpendicular to the grain can be reduced to  $\alpha_2 \geq 2,5 \cdot d$

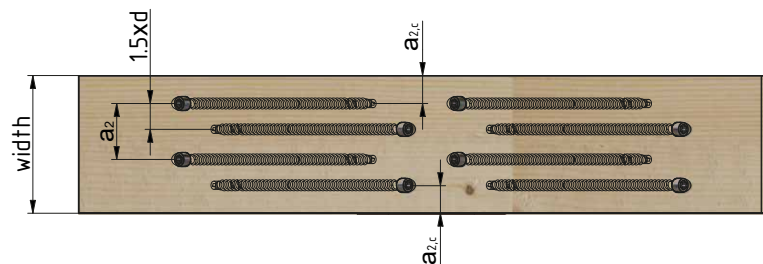
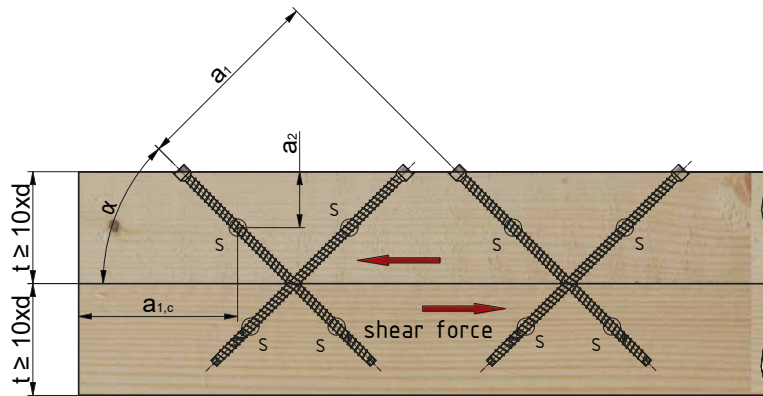

For spacing and distance requirements for each Eurotec screw, please check the respective screw section along the design guide.

# CALCULATION OF TABULATED VALUES

This is a calculation example of the axial and lateral load-carrying capacities of an Eurotec Panelwistec AG SK 6 mm x 120 mm screw on a timber-timber connection.

Component 1:

- Not predrilled
- Thickness  $t_1 = 50$  mm
- $\alpha_1 = 90^\circ$
- $\rho_{1,k} = 350$  kg/m<sup>3</sup>

Component 2:

- Not predrilled
- Thickness  $t_2 = 70$  mm
- $\alpha_2 = 90^\circ$
- $\rho_{2,k} = 350$  kg/m<sup>3</sup>

$\alpha_i$ : Angle between screw axis and wood grain direction in component i.  
In this example, it also matches the angle of the load to the grain.

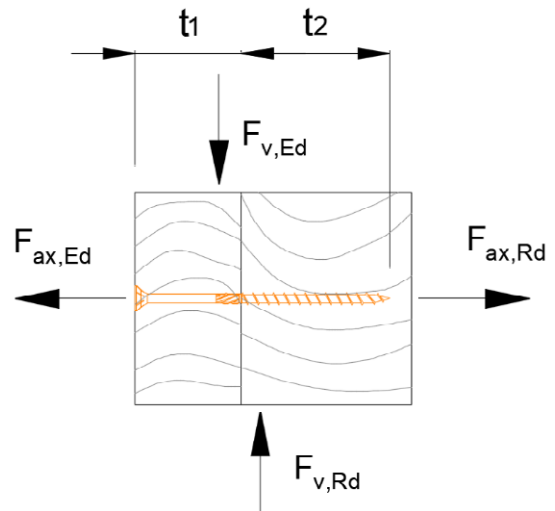

## Screw parameters as per ETA-11/0024:

- $d = 6$  mm      Nominal (major) diameter
- $d_h = 12$  mm      Head diameter
- $l_g = 70$  mm      Thread length
- $M_{y,Rk} = 9500$  Nmm      Characteristic yield moment
- $f_{ax,k} = 11,4$  MPa      Characteristic withdrawal parameter
- $f_{head,k} = 12$  MPa      Characteristic head pull-through parameter
- $f_{tens,k} = 11000$  N      Characteristic tensile strength

## Head pull-through load-carrying capacity (ETA-11/0024)

$$F_{head,Rk} = n_{ef} \cdot f_{head,k} \cdot d_h^2 \cdot \left(\frac{\rho_k}{\rho_a}\right)^{0,8}$$

- $n_{ef} = n = 1$       Effective number of screws
- $\rho_k = 350$  kg/m<sup>3</sup>      Characteristic density of the side member (Component 1)
- $\rho_a = 350$  kg/m<sup>3</sup>      Characteristic density associated with  $f_{head,k}$

$$F_{head,Rk} = 1 \cdot 12 \cdot 12^2 \left(\frac{350}{350}\right)^{0,8} = 1730 \text{ N} \quad \rightarrow \quad F_{head,Rk} = 1,73 \text{ kN}$$

**Withdrawal load-carrying capacity (ETA-11/0024)**

$$F_{ax,\alpha,Rk} = \frac{n_{ef} \cdot k_{ax} \cdot f_{ax,k} \cdot d \cdot l_{ef}}{k_{\beta}} \left( \frac{\rho_k}{\rho_{\alpha}} \right)^{0,8}$$

- $k_{ax} = 1$  Angle factor, equal to 1 for  $45^{\circ} \leq \alpha \leq 90^{\circ}$  (screw axis-grain)
- $\rho_k = 350 \text{ kg/m}^3$  Characteristic density of the main member (component 2)
- $\rho_{\alpha} = 350 \text{ kg/m}^3$  Characteristic density associated with  $f_{ax,k}$
- $l_{ef} = \min(l_g; t_2) = \min(70; 70) = 70 \text{ mm}$  Effective penetration length on main member
- $k_{\beta} = 1$  Wood product factor, equal to 1 for timber

$$F_{ax,\alpha,Rk} = \frac{1 \cdot 1 \cdot 11,4 \cdot 6 \cdot 70}{1} \left( \frac{350}{350} \right)^{0,8} = 4790 \text{ N}$$

$$\rightarrow F_{ax,\alpha,Rk} = 4,79 \text{ kN}$$

**Tensile strength capacity**

$$F_{tens,Rk} = n_{ef} \cdot f_{tens,k} = 1 \cdot 11000 = 11000 \text{ N}$$

$$\rightarrow F_{tens,Rk} = 11 \text{ kN}$$

**Axial load-carrying capacity of the screw**

$$F_{ax,Rk} = \min(F_{ax,\alpha,Rk}; F_{head,Rk}; F_{tens,Rk})$$

$$F_{ax,Rk} = \min(4,79 \text{ kN}; 1,73 \text{ kN}; 11 \text{ kN})$$

$$\rightarrow F_{ax,Rk} = 1,73 \text{ kN}$$

$$F_{ax,Rd} = \frac{F_{ax,Rk}}{\gamma_M} k_{mod}$$

$$k_{mod} = 0,8 \text{ and } \gamma_M = 1,3$$

$$F_{ax,Rd} = \frac{1,73}{1,3} \cdot 0,8$$

$$\rightarrow F_{ax,Rd} = \frac{1,73}{1,3} \cdot 0,8 = 1,06 \text{ kN}$$

**Embedment strengths**

$$f_{h,0,1,k} = 0,082 \cdot \rho_k \cdot d^{-0,3} = 0,082 \cdot \rho_k \cdot 6^{-0,3} = 16,77 \frac{N}{mm^2} = 16,77 \text{ MPa}$$

For this case, the embedment strengths in components 1 and 2 are the same, regardless of load direction and wood grain orientation.

$$\rightarrow f_{h,\alpha,2,k} = f_{h,\alpha,1,k} = 16,77 \text{ MPa}$$

The embedment strength ratio  $\beta$  for the connection is:

$$\beta = \frac{f_{h,\alpha,2,k}}{f_{h,\alpha,1,k}} = 1$$

Lateral load-carrying capacity of the screw for single shear connection (EN 1995-1-1, Eqs. 8.6)

$$a) F_{v,1,Rk} = f_{h,1,k} \cdot t_1 \cdot d = 5,03 \text{ kN}$$

$$b) F_{v,2,Rk} = f_{h,2,k} \cdot t_2 \cdot d = 7,04 \text{ kN}$$

$$c) F_{v,3,Rk} = \frac{f_{h,1,k} \cdot t_1 \cdot d}{1 + \beta} \left[ \sqrt{\beta + 2 \cdot \beta^2 \cdot \left[ 1 + \frac{t_2}{t_1} + \left( \frac{t_2}{t_1} \right)^2 \right] + \beta^3 \cdot \left( \frac{t_2}{t_1} \right)^2} - \beta \left( 1 + \frac{t_2}{t_1} \right) \right] + \frac{F_{ax,Rk}}{4} = 2,99 \text{ kN}$$

$$d) F_{v,4,Rk} = 1,05 \cdot \frac{f_{h,1,k} \cdot t_1 \cdot d}{2 + \beta} \left[ \sqrt{2 \cdot \beta \cdot (1 + \beta) + \frac{4 \cdot \beta \cdot (2 + \beta) \cdot M_{y,Rk}}{f_{h,1,k} \cdot d \cdot t_1^2}} - \beta \right] + \frac{F_{ax,Rk}}{4} = 2,38 \text{ kN}$$

$$e) F_{v,5,Rk} = 1,05 \cdot \frac{f_{h,1,k} \cdot t_2 \cdot d}{1 + 2 \cdot \beta} \left[ \sqrt{2 \cdot \beta^2 \cdot (1 + \beta) + \frac{4 \cdot \beta \cdot (1 + 2 \cdot \beta) \cdot M_{y,Rk}}{f_{h,1,k} \cdot d \cdot t_2^2}} - \beta \right] + \frac{F_{ax,Rk}}{4} = 3,04 \text{ kN}$$

$$f) F_{v,6,Rk} = 1,15 \cdot \sqrt{\frac{2 \cdot \beta}{1 + \beta}} \cdot \sqrt{2 \cdot M_{y,Rk} \cdot f_{h,1,k} \cdot d} + \frac{F_{ax,Rk}}{4} = 2,02 \text{ kN}$$

$$F_{v,Rk} = \min(F_{v,i,Rk}) = 2,02 \text{ kN} \quad \rightarrow \quad F_{v,Rd} = \frac{F_{v,Rk}}{\gamma_M} k_{mod} = 1,24 \text{ kN}$$

Failure mode f) controls the design and ductility is ensured by double plastic hinge due to yielding of the fastener and embedment of the wood.

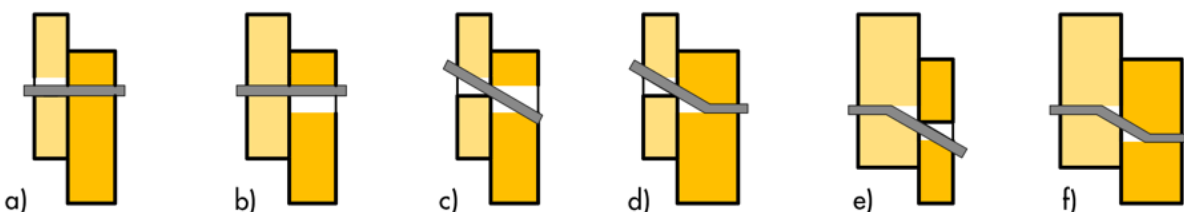

# APPLICATION EXAMPLES

## TIMBER-TIMBER CONNECTION: PURLIN TO RAFTER

### Connection details:

Purlin width x height ( $w_p \times h_p$ ) = 120 mm x 220 mm ; Material: C30 timber

Rafter width x height ( $w_R \times h_R$ ) = 140 mm x 360 mm ; Material: C30 timber

### Service and load conditions:

Combination of pull-out and shear load:  $F_{ax,Ed} = 2,5$  kN,  $F_{v,Ed} = 2$  kN

Service class 1, medium-term load-duration class

### Connection requirement:

Solve connection with a partially threaded screw flush with the purlin's upper edge.

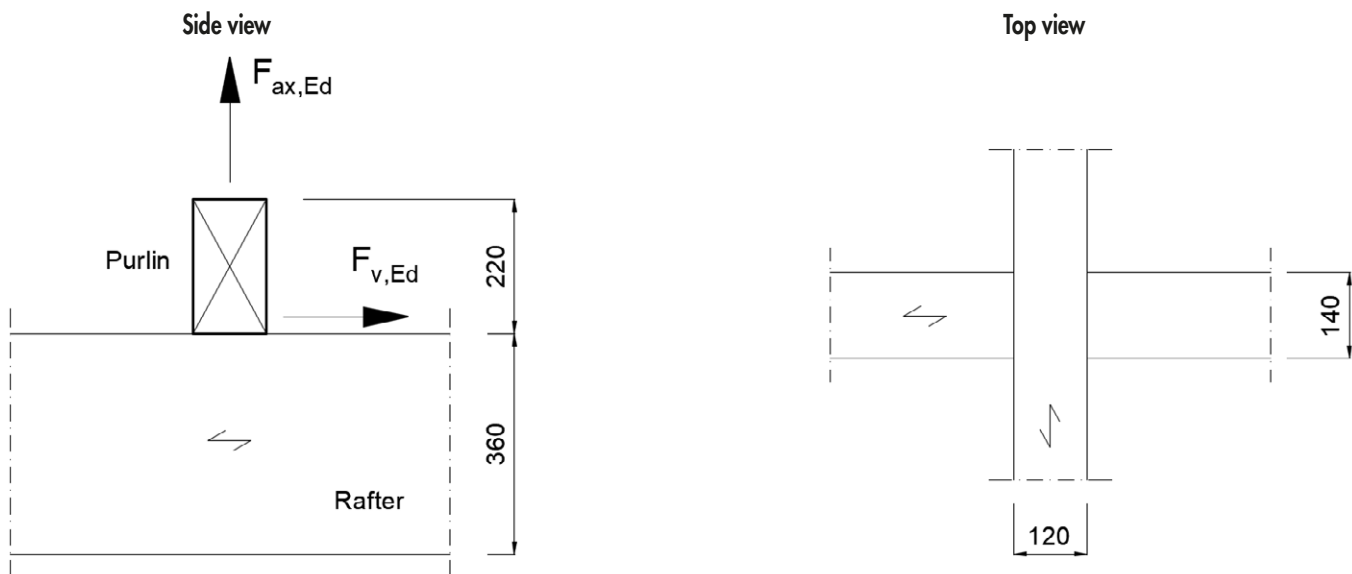

→ to Paneltwistec AG SK Design Tables, axial load-carrying capacity, with  $A = h_p = 220$  mm

Paneltwistec AG SK Ø 8 mm

$L = 320$  mm Minimum length required

$F_{ax,Rd} = 1,55$  kN Axial load-carrying capacity design value per screw

→ to Paneltwistec AG SK Design Tables, lateral load-carrying capacity, with  $A = h_p = 220$  mm

Paneltwistec AG SK Ø 8 mm

$L = 320$  mm Minimum length required

$F_{v,Rd} = 2,24$  kN Lateral load-carrying capacity design value per screw

**Minimum distances according to ETA-11/0024:**

$$\begin{aligned} \alpha_2 &\geq 5 \cdot d = 5 \cdot 8 &&= 40 \text{ mm} \rightarrow 60 \text{ mm adopted} \\ \alpha_{4,c} &\geq 5 \cdot d = 5 \cdot 8 &&= 40 \text{ mm} \\ \alpha_{4,t} &\geq (5 + 5 \cdot \sin\alpha) \cdot d = (5 + 5 \cdot \sin 90^\circ) \cdot 8 &&= 80 \text{ mm (to purlin's edge, unloaded)} \\ \alpha_{4,t} &\geq (5 + 5 \cdot \sin\alpha) \cdot d = (5 + 5 \cdot \sin 0^\circ) \cdot 8 &&= 40 \text{ mm (to purlin's left edge, loaded)} \end{aligned}$$

**Note:** minimum edge and end distances ( $\alpha_4, \alpha_3$ ) should be considered as loaded for both sides under reversible load scenarios like wind and earthquakes.

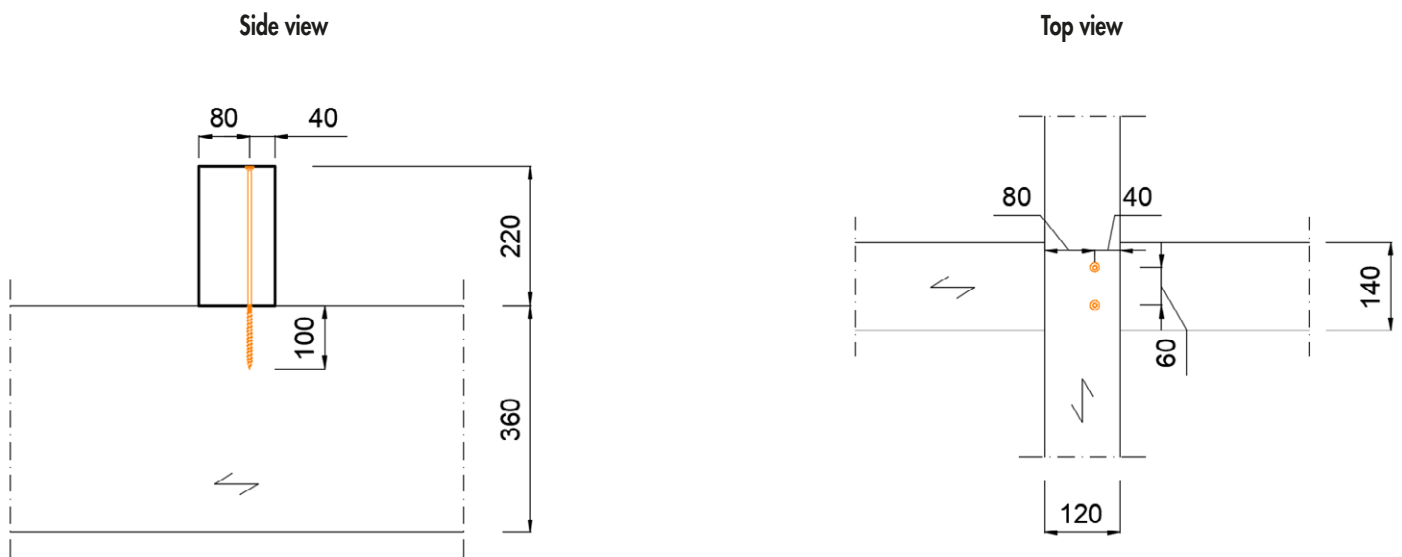
**Effective number of screws:**

$$\begin{aligned} n_{ax,ef} &= 2^{0,9} = 1,87 \\ n_{v,ef} &= 2 \text{ (two rows of 1 screw each)} \end{aligned}$$

Strength verification of screwed connection:

$$\left( \frac{F_{ax,Ed}}{n_{ax,ef} \cdot F_{ax,Rd}} \right)^2 + \left( \frac{F_{v,Ed}}{n_{v,ef} \cdot F_{v,Rd}} \right)^2 = \left( \frac{2,5}{1,87 \cdot 1,55} \right)^2 + \left( \frac{2}{2 \cdot 2,24} \right)^2 = 0,94 \leq 1,0 \quad \checkmark$$

# APPLICATION EXAMPLES

## TIMBER-TIMBER CONNECTION: SHEAR-TENSION SCREWS

### Connection details:

Side members  $w_S \times h_S = 100 \text{ mm} \times 380 \text{ mm}$  ; Material: C30 grade timber

Middle member  $w_M \times h_M = 200 \text{ mm} \times 380 \text{ mm}$  ; Material: C30 grade timber

### Service and load conditions:

Load parallel applied on middle member, parallel to the shear planes:  $F_{v,Ed} = 230 \text{ kN}$

Service class 1, medium-term load-duration class

### Connection requirement:

Solve connection with  $45^\circ$ -angled fully threaded screws on both side members.

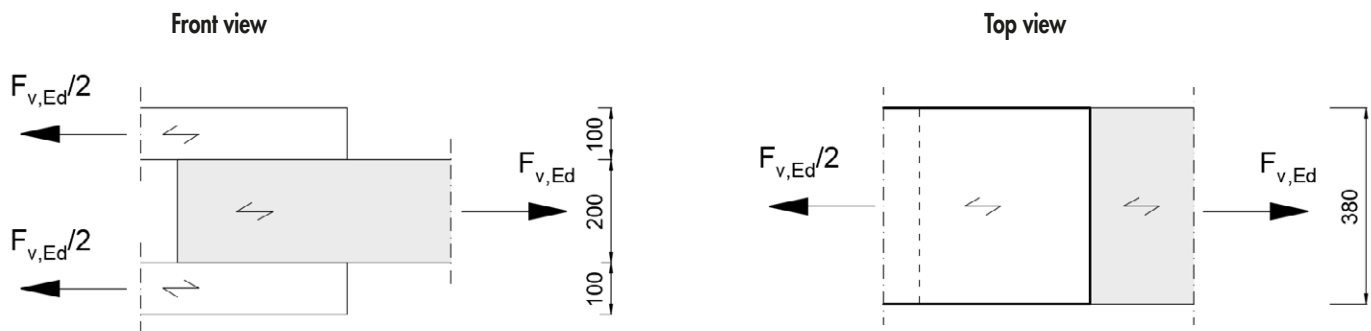

→ to KonstruX ST ZK Design Tables, load carrying capacity of shear-tension screws, with  $A = h_s = 100 \text{ mm}$

KonstruX ST ZK  $\varnothing 8 \text{ mm}$

$L = 245 \text{ mm}$  Minimum length required

$F_{v,Rd} = 4,28 \text{ kN}$  Load-carrying capacity design value per shear-tension screw

Considering that the following conditions are met, friction between timber components is considered with  $\mu = 0,25$ : (i) the screws are installed correctly with the right installation torque; (ii) the bearing area is sufficient and minimum spacings are met; (iii) there are no gaps between members.



Number of effective screws required per side member:

$$F_{v,Rd}(1 + \mu) \cdot n_{ef} = \frac{F_{Ed}}{2}$$

$$\rightarrow n_{ef,req} = \frac{F_{Ed}}{2 \cdot F_{v,Rd}(1 + \mu)} = \frac{230}{2 \cdot 4,28(1 + 0,25)} \geq 21,49 \approx 22$$

Minimum distances according to ETA-11/0024:

$$a_1 \cdot a_2 \geq 25 \cdot d = 25 \cdot 82 = 1600 \text{ mm}^2$$

$$a_1 \geq 5d = 40 \text{ mm} \quad \rightarrow 99 \text{ mm adopted} \quad (\text{spacing parallel to grain between screws in a row})$$

$$\frac{a_1}{\cos 45^\circ} = 140 \text{ mm}$$

$$a_2 \geq 2,5d = 20 \text{ mm} \quad \rightarrow 26 \text{ mm adopted} \quad (\text{spacing perpend. to grain between rows of screws})$$

$$\rightarrow 100 \cdot 25 = 2475 \text{ mm}^2 \geq 25 \cdot d = 25 \cdot 82 = 1600 \text{ mm}^2 \quad \checkmark \text{ reduced spacing can be used for } a^2$$

$$a_{1,c} \geq 5d = 40 \text{ mm} \quad \rightarrow 136 \text{ mm adopted} \quad (\text{distance from CG of the screw in timber member to the end grain})$$

$$a_{2,c} \geq 3c = 24 \text{ mm} \quad \rightarrow 40 \text{ mm adopted} \quad (\text{distance from CG of the screw part in timber member to the edge})$$

$$s \geq 1,5d = 12 \text{ mm} \quad \rightarrow 14 \text{ mm adopted} \quad (\text{spacing between pair of crossed screws})$$

Maximum number of screws aligned perpendicular to grain direction:

$$n_{90,max} \leq 1 + \frac{(h_s - 2 \cdot a_{c,2} - s)}{a_2} = 1 + \frac{(380 - 2 \cdot 40 - 14)}{26} = 12$$

Number of effective screws required in a row parallel to grain:

$$n_{0,ef,req} \geq \frac{n_{ef,req}}{n_{90,max}} = \frac{22}{12} \geq 1,83 \rightarrow 2 \text{ adopted}$$

$$n_{0,ef} = n_{ef} = n^{0,9} = 2^{0,9} = 1,87$$

Strength verification of screwed connection:

$$\frac{F_{v,Ed}}{n_{ef} \cdot F_{v,Rd}} = \frac{230}{2 \cdot (1,87 \cdot 12) \cdot 1,25 \cdot 4,28} = 0,96 \leq 1,0 \quad \checkmark$$

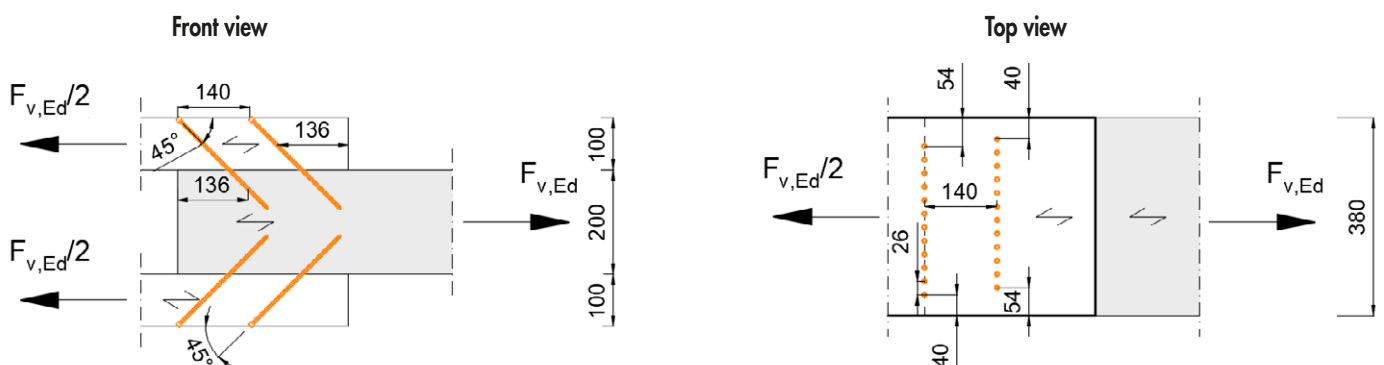

# APPLICATION EXAMPLES

## TIMBER-TIMBER CONNECTION: JOIST TO HEADER

### Connection details:

Main beam  $w_{MB} \times h_{MB} = 160 \text{ mm} \times 240 \text{ mm}$  ; Material: C30 timber

Secondary beam  $w_{SM} \times h_{SB} = 80 \text{ mm} \times 200 \text{ mm}$  ; Material: C30 timber

Header must be torsion-restrained. Any eccentricity moments should be considered for the verification of components.  
Top edges of main and secondary beams are arranged flush to each other. Screws must be inserted flush with the surface.

### Service and load conditions:

Shear load (shear-tension on inclined screws):  $F_{v,Ed} = 9,2 \text{ kN}$

Service class 1, medium-term load-duration class

### Connection requirement:

Solve connection with fully threaded screw crosses at  $45^\circ$ .

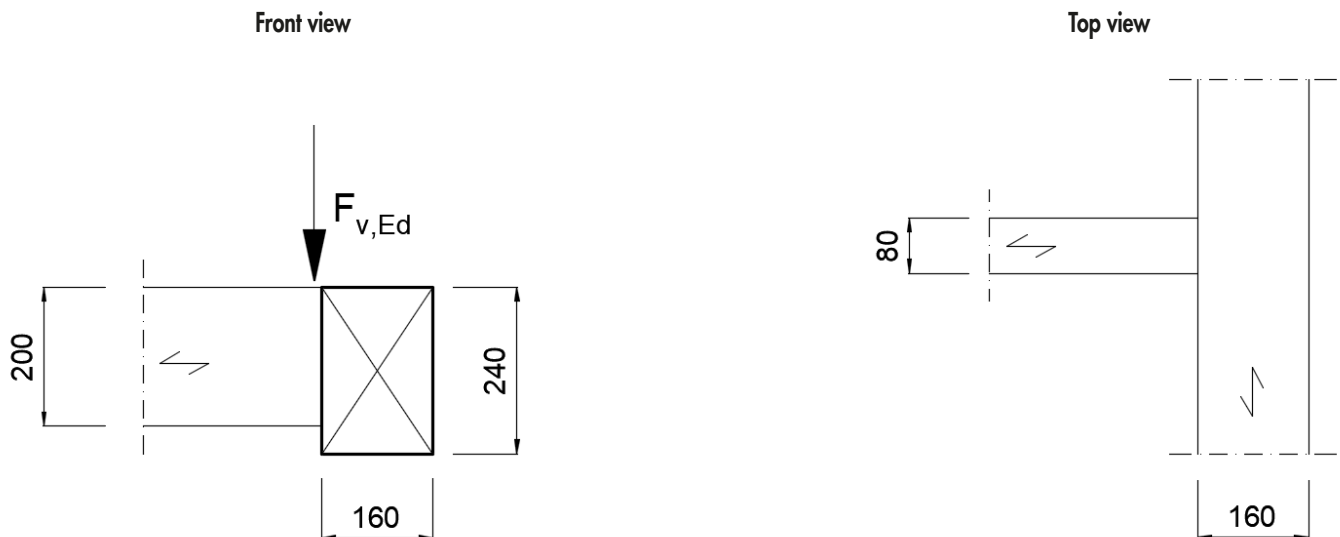

→ to KonstruX ST Design Tables, load carrying capacity of screw crosses, with  $F_{v,Rd} \geq 9,2 \text{ kN}$

1 pair x KonstruX ST ZK  $\varnothing 8 \text{ mm}$

$L = 245 \text{ mm}$  Minimum length required

$F_{v,Rd} = 10,11 \text{ kN}$  Shear-tension load-carrying capacity design value per screw cross

**Verification of minimum components dimensions:**

$$w_{SB,min} = 80 \text{ mm} \rightarrow w_{SB} = 80 \text{ mm} \quad \checkmark$$

$$h_{SB,min} = 200 \text{ mm} \rightarrow h_{SB} = 200 \text{ mm} \quad \checkmark$$

$$w_{MB,min} = 100 \text{ mm} \rightarrow w_{MB} = 160 \text{ mm} \quad \checkmark$$

$$h_{MB,min} = 200 \text{ mm} \rightarrow h_{MB} = 240 \text{ mm} \quad \checkmark$$

Minimum spacings are verified:

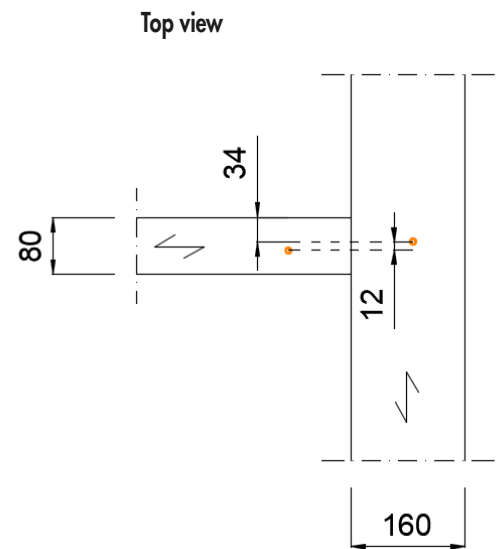
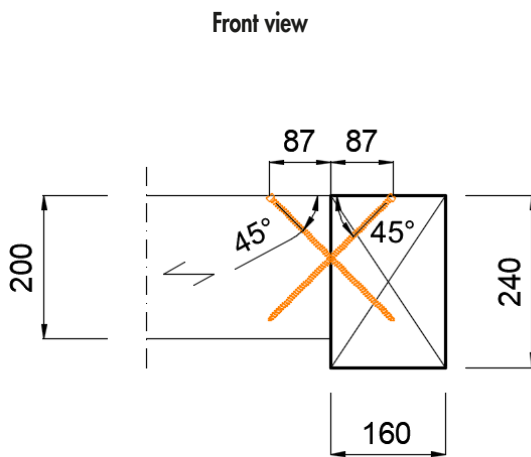

The effective number of screws  $n_{ef}$  is already considered in the calculation of table values.  
Strength verification of screwed connection:

$$\frac{F_{v,Ed}}{F_{v,Rd}} = \frac{9,2}{10,11} = 0,91 \leq 1,0$$

# APPLICATION EXAMPLES

## TIMBER-TIMBER CONNECTION: BEAM TO POST

### Connection details:

Post  $w_P \times h_P = 200 \text{ mm} \times 200 \text{ mm}$  ; Material: C24 timber

Beam  $w_B \times h_B = 200 \text{ mm} \times 360 \text{ mm}$  ; Material: C24 timber

### Service and load conditions:

Shear load:  $F_{v,Ed} = 14 \text{ kN}$

Service class 1, medium-term load-duration class

### Connection requirement:

This connection is designed using partially threaded screws with a washer head that flush the external edge of the post.

Note: Although this connection solution is possible, using a beam-hanger connector or fully threaded screws in a crosswise configuration would be more effective.

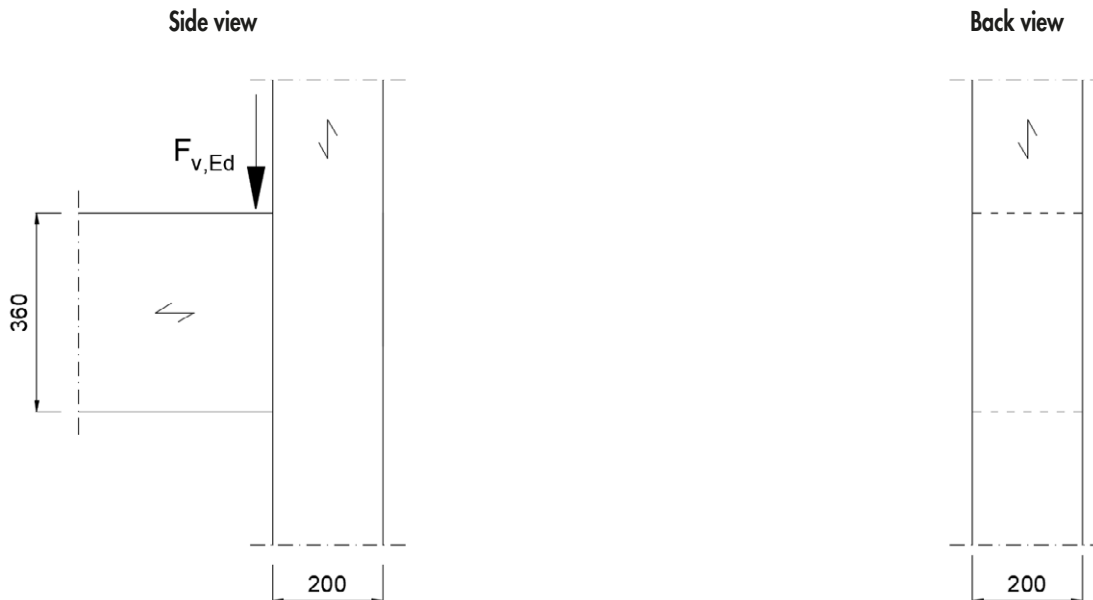

→ to Paneltwistec AG Washer head Design Tables, lateral load-carrying capacity, with  $A = w_P = 200 \text{ mm}$

Paneltwistec AG Washer head  $\varnothing 10 \text{ mm}$

$L = 300 \text{ mm}$  Minimum length required

**Minimum penetration length in beam according to ETA-11/0024 (3.4):**

$$l_{ef,min} \geq 20 \cdot d = 20 \cdot 10 = 200 \text{ mm}$$

$$l - w_p = 300 - 200 = 100 \text{ mm} < l_{ef,min} \rightarrow \text{doesn't verify}$$

$$l \geq l_{ef,min} + w_p = 400 \text{ mm}$$

→ Paneltwistec AG Washer head  $\varnothing$  10 mm x 400 mm adopted

$$F_{v,Rd} = 3,87 \text{ kN} \quad \text{Lateral load-carrying capacity design value per screw}$$

**Approximate number of screws required:**

$$n = \frac{F_{v,Ed}}{F_{v,Rd}} = \frac{14}{3,87} = 3,62 \rightarrow 4$$

**Minimum distances according to EN 1995-1-1:**

Note that in the following formulas  $\alpha$  is the angle between the force and wood grain direction.

$$\alpha_1 \geq (5 + 7|\cos\alpha|) \cdot d = (5 + 7|\cos 0^\circ|) \cdot 10 = 120 \text{ mm}$$

$$\alpha_2 \geq 5 \cdot d = 5 \cdot 10 = 50 \text{ mm} \rightarrow 100 \text{ mm adopted}$$

$$\alpha_{4,c} \geq 5 \cdot d = 5 \cdot 10 = 50 \text{ mm (distance to unloaded edges)}$$

$$\alpha_{4,t} \geq (5 + 5 \cdot \sin\alpha) \cdot d = (5 + 5 \cdot \sin 90^\circ) \cdot 10 = 100 \text{ mm (distance to loaded edges)}$$

**Effective number of screws according to EN 1995-1-1 8.3 (8):**

$$\frac{a_1}{d} = \frac{120}{10} = 12 \rightarrow k_{ef} = 0,93 \text{ (linearly interpolated with Table 8.1 of the standard)}$$

$$n_{0,ef} = n^{k_{ef}} = 2^{0,93} = 1,90 \text{ (assuming a connection with 2 rows of screws)}$$

$$n_{ef} = n_{90} \cdot n_{0,ef} = 2 \cdot 1,90 = 3,8$$

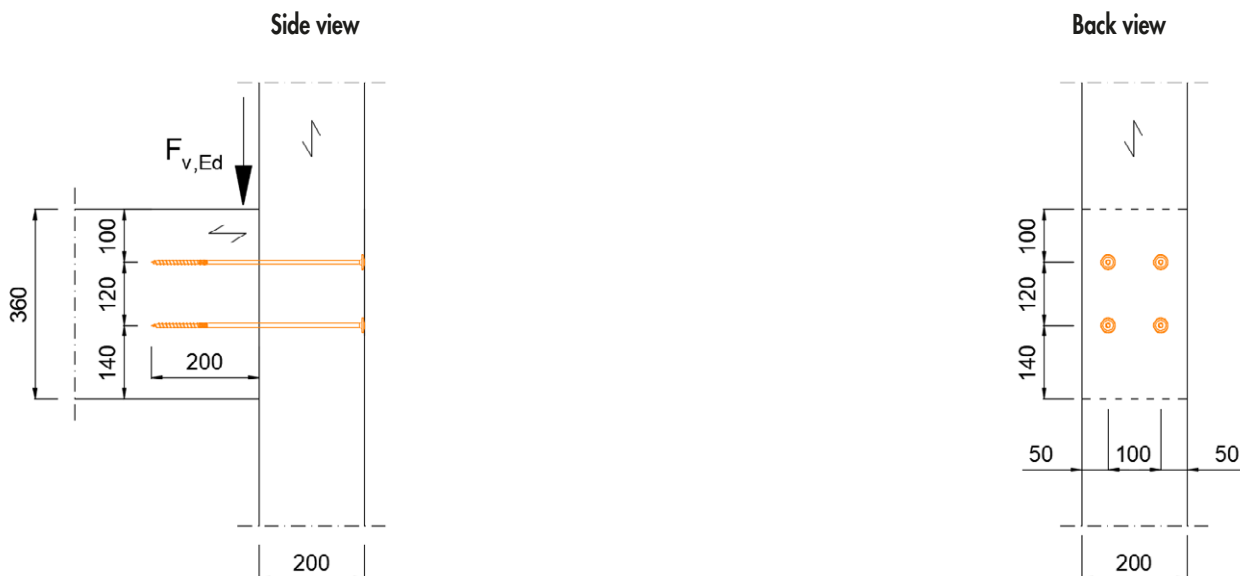
**Strength verification of screwed connection:**

$$\frac{F_{v,Ed}}{n_{ef} \cdot F_{v,Rd}} = \frac{14}{3,8 \cdot 3,87} = 0,95 \leq 1,0 \quad \checkmark$$

# APPLICATION EXAMPLES

## STEEL-TIMBER CONNECTION: SHEAR CONNECTION

### Connection details:

Timber  $w \times h = 100 \text{ mm} \times 270 \text{ mm}$  ; Material: C24 timber

Steel plate  $t_s = 3 \text{ mm}$

### Service and load conditions:

Shear load:  $F_{v,Ed} = 120 \text{ kN}$

Service class 1, medium-term load-duration class

### Connection requirement:

Solve connection with countersunk head partially threaded screws flush with the steel plate.

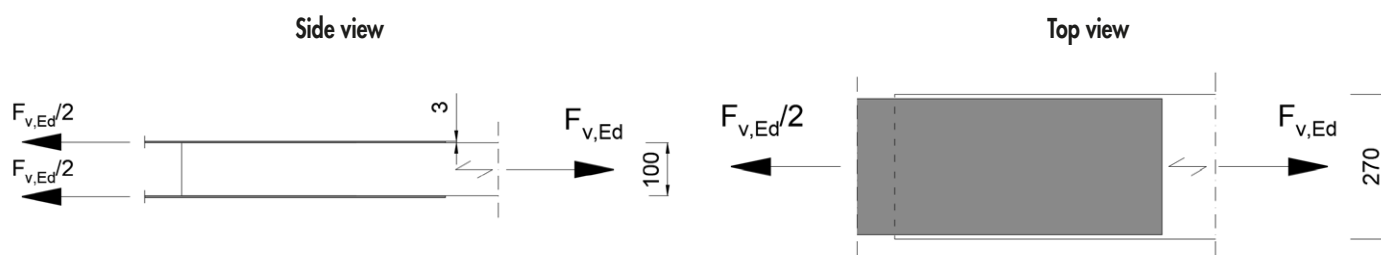

→ to Paneltwistec AG SK Design Tables, lateral load-carrying capacity, with  $A = w = 100 \text{ mm}$ ,  $t_s = 3 \text{ mm}$  (thin plate)

Paneltwistec AG SK  $\varnothing 8 \text{ mm}$

$L = 100 \text{ mm}$  Minimum length required

$F_{v,Rd} = 2,87 \text{ kN}$  Lateral load-carrying capacity design value per screw

The screwing pattern is chosen so that the effective number of screws is not reduced, as per EN 1995-1-1. To this end, the screws lying one behind each other in the same row parallel to grain direction are staggered a spacing perpendicular to grain equal to  $1d$ .

### Number of effective screws required per side member:

$$n_{ef,req} = \frac{F_{v,Ed}}{2 \cdot F_{v,Rd}} = \frac{120}{2 \cdot 2,87} \geq 20,91 \rightarrow 21$$

**Minimum distances according to EN 1995-1-1:**

Factor 0,7 is used to reduce  $a_1$  and  $a_2$  spacings, according to the standard.

Note that in the following formulas  $\alpha$  is the angle between the force and wood grain direction.

$$\begin{aligned}
 a_1 &\geq 0,7 \cdot (5 + 7 \cdot |\cos\alpha|) \cdot d = 0,7 \cdot (5 + 7 \cdot |\cos 0^\circ|) \cdot 8 = 67,2 \text{ mm} && \rightarrow 70 \text{ mm adopted} \\
 a_2 &\geq 0,7 \cdot 5 \cdot d = 0,7 \cdot 5 \cdot 8 = 28 \text{ mm} && \rightarrow 30 \text{ mm adopted} \\
 a_{3,t} &\geq (10 + 5 \cdot \cos\alpha) \cdot d = (10 + 5 \cdot \cos 0^\circ) \cdot 8 = 120 \text{ mm} && \rightarrow 120 \text{ mm adopted} \\
 a_{4,c} &\geq 5 \cdot d = 5 \cdot 8 = 40 \text{ mm} && \rightarrow 41 \text{ mm adopted}
 \end{aligned}$$

Maximum number of screws aligned perpendicular to grain direction:

$$n_{0,ef,req} \geq \frac{n_{ef,req}}{n_{90,max}} = \frac{21}{7} \geq 3$$

$$n_{ef} = 3 \cdot 7 = 21$$

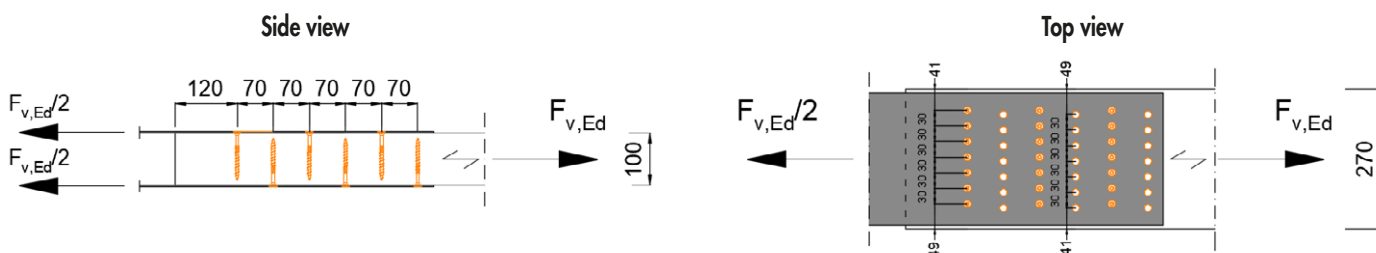

Strength verification of screwed connection:

$$\frac{F_{v,Ed}}{2 \cdot n_{ef} \cdot F_{v,Rd}} = \frac{120}{2 \cdot (3 \cdot 7 \cdot 2,87)} = 0,99 \leq 1,0 \quad \checkmark$$

# KONSTRUX FULLY THREADED SCREW

The high-performance solution for new construction and reinforcement



KonstruX fully threaded screws maximize the load-bearing capacity of a connection due to the high thread extraction resistance in both components. When using partially threaded screws, the significantly lower head pull-through resistance in the attachment part limits the load-bearing capacity of the connection. KonstruX fully threaded screw provides a cost-saving alternative to traditional connectors or timber connectors such as joist shoes and joist girders.

### Head shapes

**Countersunk head**



- Prevents splitting of the wood
- Flush finish with the surface

**Cylinder head**





- Vanishes in the wood surface
- Ideal for tight spaces

**External TX head**



- Extraordinary torque transmission
- Washer increases tightness



**TX Drive** 

- Allows high torque transmission
- Prevents camout

**SC 1-2** 

**Coarse thread**

- Speeds up the screwing-in process

**Tip types**

**AG**



- Reduces the screwing torque
- Reduces wood splitting

**Drill tip**



- No pre-drilling needed
- Allows reduction of minimum spacing requirements
- Reduces the screwing torque

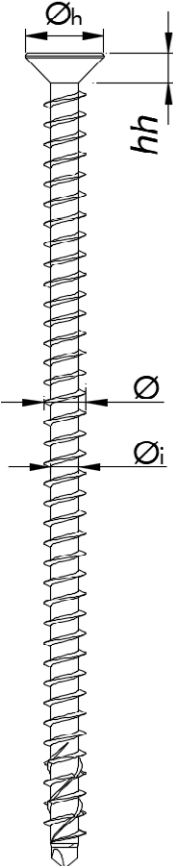

## KonstruX Hardened Carbon Steel

Geometric properties					Mechanical properties			
Nominal Ø [mm]	Inner Ø <sub>i</sub> [mm]	Head <sup>a)</sup> Ø <sub>h</sub> [mm]	Head depth <sup>a)</sup> hh [mm]	Tip type	f <sub>tens,k</sub> [kN]	f <sub>ax,k</sub> [MPa]	M <sub>y,k</sub> [Nm]	F <sub>ki,Rk</sub> <sup>b)</sup> [kN]
6,5	4,5	11,5/8,0	5,7/5,5	Drill	17,0	11,4	15,0	9,0
8	5,2	14,5/10	7,4/6,5	Drill	25,0	11,1	25,0	12,3
10	5,9	17,8/13	8,7/6,5	Drill	33,0	10,8	40,0	16,1
11,3	8,0	18,0	7,0	AG	50,0	10,8	70,0	20,9
13	9,2	18,0	10,0	AG	75,0	10,8	120,0	27,4







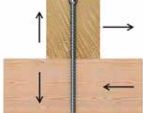

a) Countersunk head / Cylinder head

b) Characteristic buckling capacity F<sub>ki,Rk</sub> calculated for ρ<sub>k</sub> = 380 kg/m<sup>3</sup>.



# KONSTRUX SCREWS: STRONG AXIAL RESISTANCE FOR A RELIABLE TIMBER CONNECTION

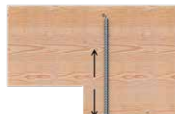
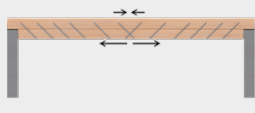

Application examples	Cylinder head			Countersunk head				External TX head
	Ø 6,5 [mm]	Ø 8,0 [mm]	Ø 10,0 [mm]	Ø 6,5 [mm]	Ø 8,0 [mm]	Ø 10,0 [mm]	Ø 11,3 [mm]	Ø 13,0 [mm]
Timber-Timber tensile and shearing loading 	x	x	x	x	x	x	x	x
Timber-timber under tension at 45° 	x	x	x	x	x	x	x	x
Steel-Timber tensile and shearing loading 	—	—	—	x	x	x	x	x
Steel-timber under tension at 45° 	—	—	—	x	x	x	x	—
Main-secondary beam connection 	x	x	x	x	x	x	x	—
Reinforcement of supports 	x	x	x	x	x	x	x	x
Reinforcement of notches and openings on beams 	x	x	x	x	x	x	x	x
Beam doubling 	—	x	x	—	x	x	x	x
Reinforcement of curved and tapered beams 	—	—	x	—	—	x	x	x

# KONSTRUX EXTERNAL TX HEAD Ø 13 mm: REINFORCEMENT APPLICATIONS

Either by architectural or MEP (Mechanical, Electrical and Plumbing) system requirements in a building, sometimes it may be needed to reduce the cross-section of timber beams at certain locations using holes or notches.

Structural engineering principles and experimental testing prove that sudden changes in geometry cause extraordinary stress gradients. When it comes to wood, this is especially jeopardizing due to its anisotropic nature, triggering weak stress states. For example, a C24 graded timber has a characteristic tension strength perpendicular to grain 35 times smaller than parallel to grain, so one can imagine how and where cracks will begin to develop.

The KonstruX External TX head Ø 13 mm is specially designed for heavy duty timber reinforcement. In high-rise mass timber buildings and large-scale hangar frames, glulam elements can reach massive dimensions to be able to meet structural goals. In line with this, Konstrux Ø 13 mm screws are suitable for reinforcing these extraordinary timber components, being available as long as 1400 mm.

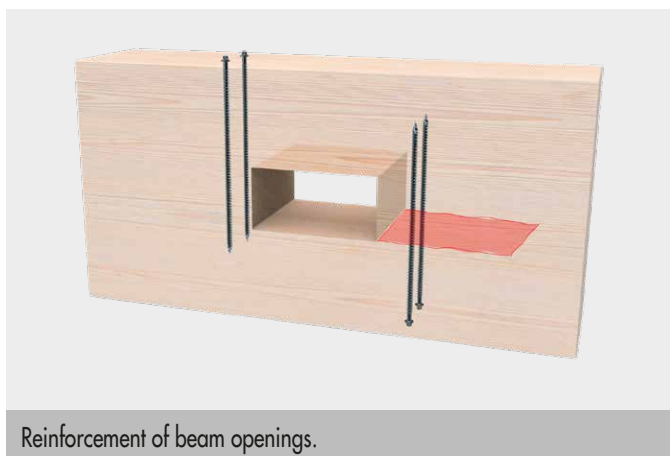

Reinforcement of beam openings.



Reinforcement of main-secondary beam supports.

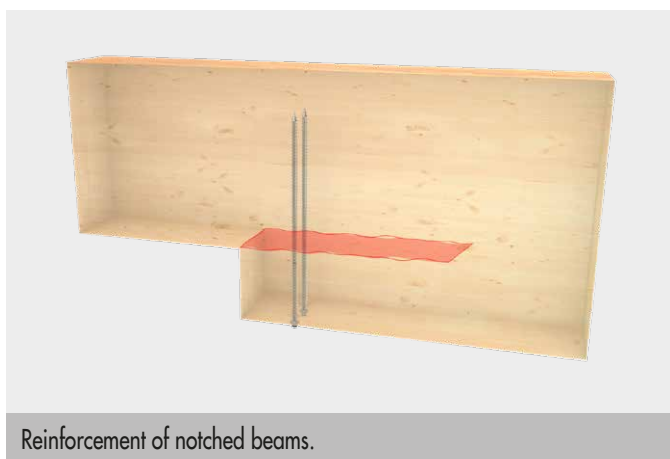

Reinforcement of notched beams.



Reinforcement of pitch cambered beams.

In the case of screws used as reinforcement, the effective number of screws can be considered as  $n_{ef} = n$ .



**Note**  
KonstruX Ø 11,3 mm is also suitable for the above mentioned reinforcement applications.

# MINIMUM DISTANCES FOR AXIAL LOADS

KonstruX ST (Drill tip)					KonstruX (AG tip)					
Ø [mm]	Rules	With and without predrilled holes			Predrilled holes			Non-predrilled holes		
		6,5	8	10	Rules	11,3	13	Rules	11,3	13
$a_1$	5 · d	33	40	50	5 · d	57	65	5 · d	57	65
$a_2$	5 · d	33	40	50	5 · d	57	65	5 · d	57	65
$a_{2,red}$	2,5 · d	16	20	25	2,5 · d	29	33	2,5 · d	29	33
$a_{1,c}$	5 · d	33	40	50	5 · d	57	65	10 · d	113	130
$a_{2,c}$	3 · d	20	24	30	3 · d	34	39	4 · d	46	52
$a_x$	1,5 · d	10	12	15	1,5 · d	17	20	1,5 · d	17	20

## Crossed screws under tension

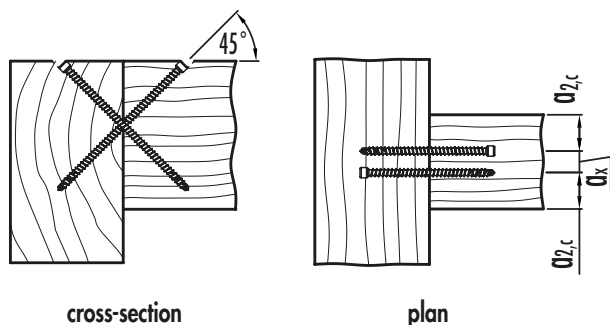

## Screws inserted perpendicular to the grain

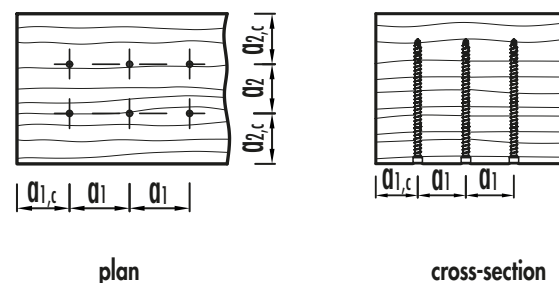

## Tensioned screws inserted with an angle α with respect to the wood grain direction

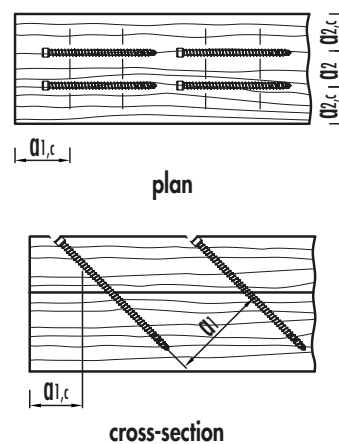
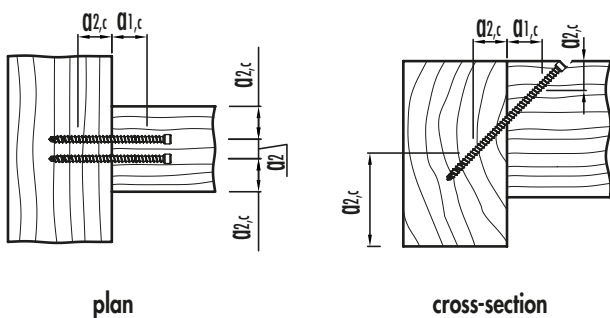

Notes: The minimum distances for axially-loaded screws are in accordance with ETA-11/0024 considering a softwood density of  $\rho_k \leq 420 \text{ kg/m}^3$ , where  $d$  = nominal screw diameter, minimum wood thickness,  $t = 10 \cdot d$  and minimum width,  $w = \max[8 \cdot d; 60 \text{ mm}]$ . For steel-to-timber joints, the axial spacings  $a_1$  and  $a_2$  can be reduced by a factor of 0,7.

# MINIMUM DISTANCES FOR SHEAR LOADS

## KonstruX (AG and Drill tip)

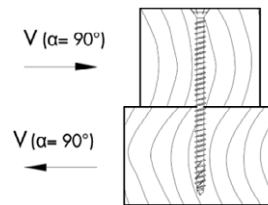
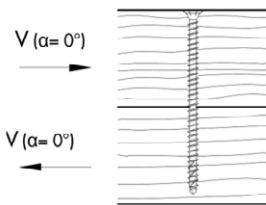

Ø [mm]	Predrilled holes				Predrilled holes			
	Rules	6,5	8	10	Rules	6,5	8	10
a <sub>1</sub>	5 · d	33	40	50	4 · d	26	32	40
a <sub>2</sub>	3 · d	20	24	30	4 · d	26	32	40
a <sub>3,c</sub>	7 · d	46	56	70	7 · d	46	56	70
a <sub>3,t</sub>	12 · d	78	96	120	7 · d	46	56	70
a <sub>4,c</sub>	3 · d	20	24	30	3 · d	20	24	30
a <sub>4,t</sub>	3 · d	20	24	30	7 · d	46	56	70

Ø [mm]	Non-predrilled holes				Non-predrilled holes			
	Rules	6,5	8	10	Rules	6,5	8	10
a <sub>1</sub>	12 · d	78	96	120	5 · d	33	40	50
a <sub>2</sub>	5 · d	33	40	50	5 · d	33	40	50
a <sub>3,c</sub>	10 · d	65	80	100	10 · d	65	80	100
a <sub>3,t</sub>	15 · d	98	120	150	10 · d	65	80	100
a <sub>4,c</sub>	5 · d	33	40	50	5 · d	33	40	50
a <sub>4,t</sub>	5 · d	33	40	50	10 · d	65	80	100

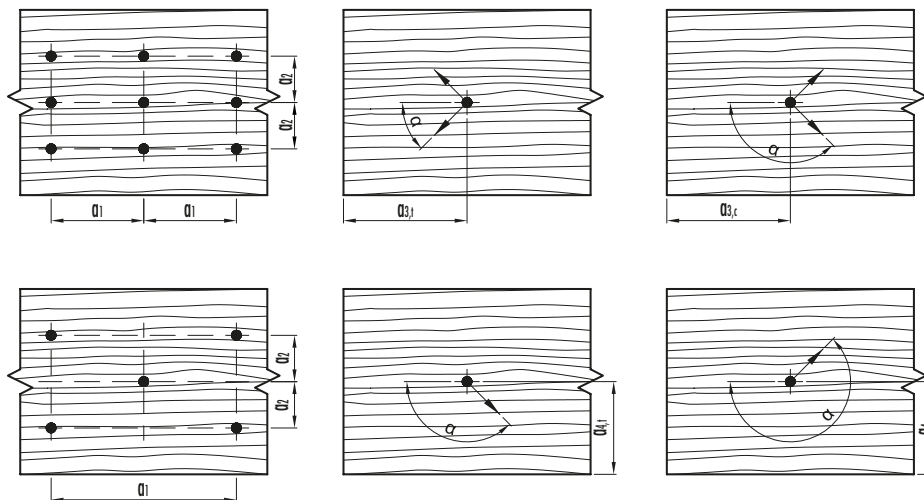

Notes: The minimum distances for axially-loaded screws are in accordance with ETA-11/0024 considering a softwood density of  $\rho_k \leq 420 \text{ kg/m}^3$ , where  $d$  = nominal screw diameter, minimum wood thickness,  $t = 10 \cdot d$  and minimum width,  $w = \max[8 \cdot d; 60 \text{ mm}]$ . For steel-to-timber joints, the axial spacings  $a_1$  and  $a_2$  can be reduced by a factor of 0,7. In wood members of Douglas fir, the minimum distances must be increased by 1,5. The edge distances and spacings of each timber member must be checked independently according to load and grain direction.

# KONSTRUX: DESIGN TABLES

## KONSTRUX ST COUNTERSUNK HEAD



Axial load-carrying capacity of screws with minimum required lengths.

A [mm]	Ø 6,5 mm			Ø 8 mm			Ø 10 mm		
	$F_{ax,Rk}$ [kN]	$F_{ax,Rd}$ [kN]	L [mm]	$F_{ax,Rk}$ [kN]	$F_{ax,Rd}$ [kN]	L [mm]	$F_{ax,Rk}$ [kN]	$F_{ax,Rd}$ [kN]	L [mm]
40	2,71	1,67	80						
40	2,71	1,67	100	3,09	1,90	95			
60	4,30	2,64	120	4,99	3,07	125	5,92	3,64	125
80	4,75	2,92	140	6,89	4,24	155	8,22	5,06	155
100				8,78	5,40	195	10,53	6,48	195
120				9,48	5,84	220	11,53	7,10	220
120				10,76	6,62	245	12,84	7,90	245
140				12,66	7,79	295	14,99	9,23	270
160				14,56	8,96	330	16,15	9,94	300
160				14,56	8,96	375	17,45	10,74	330
180				16,45	10,13	375	19,76	12,16	360
200				18,27	11,24	400	22,07	13,58	400
220				19,92	12,26	430	24,37	15,00	450
240				22,06	13,58	480	26,68	16,42	500
260				23,96	14,74	545	28,99	17,84	550
300							33,00	20,68	600
340							33,00	22,00	650
360							33,00	24,13	700
380							33,00	26,26	750
400							33,00	26,26	800

Calculated according to EN 1995-1-1, with non-pre-drilled holes and wood density  $\rho_k = 380 \text{ kg/m}^3$ . Design values  $F_{Rd}$  calculated considering  $k_{mod} = 0,8$  and  $\gamma_M = 1,3$  and  $\gamma_{M2} = 1,25$ . For the longer screws, design values may differ from the corresponding characteristic failure mode (withdrawal or steel tension fracture). Component B thickness is such that:  $B \geq L - A$ . L is the minimum screw length for achieving the respective load-carrying capacity.

**Please note:** These are planning aids. Projects must be calculated only by authorized persons.

## KONSTRUX ST COUNTERSUNK HEAD – TIMBER-TIMBER

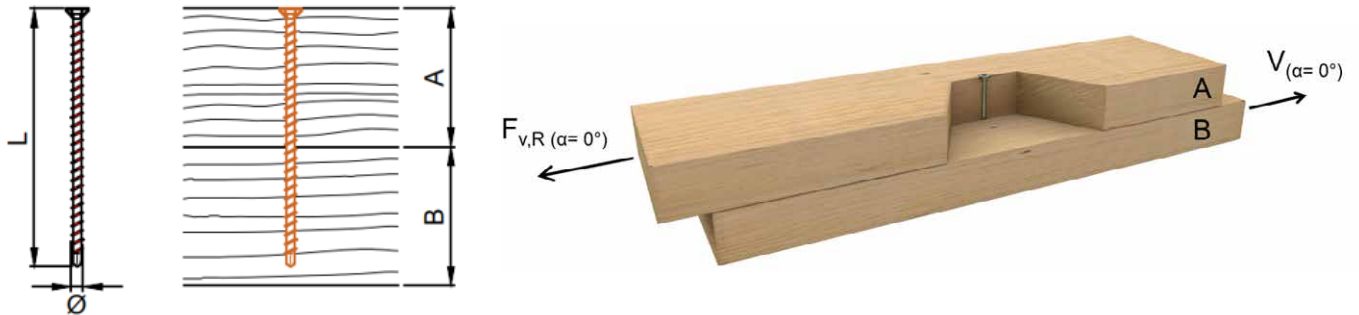

Lateral load-carrying capacity of screws with minimum required lengths.

A [mm]	Ø 6,5 mm			Ø 8 mm			Ø 10 mm		
	$F_{v,Rk}$ [kN]	$F_{v,Rd}$ [kN]	L [mm]	$F_{v,Rk}$ [kN]	$F_{v,Rd}$ [kN]	L [mm]	$F_{v,Rk}$ [kN]	$F_{v,Rd}$ [kN]	L [mm]
40	3,42	2,10	80						
40	3,42	2,10	100	4,61	2,84	95			
60	3,82	2,35	120	5,14	3,17	125	6,93	4,26	125
80	3,93	2,42	140	5,62	3,46	155	7,50	4,62	155
100				6,09	3,75	195	8,08	4,97	195
120				6,27	3,86	220	8,33	5,13	220
120				6,59	4,06	245	8,66	5,33	245
140				7,06	4,34	295	9,20	5,66	270
160				7,53	4,63	330	9,48	5,83	300
160				7,53	4,63	375	9,81	6,04	330
180				7,79	4,79	375	10,39	6,39	360
200				7,79	4,79	400	10,89	6,70	400
220				7,79	4,79	430	10,89	6,70	450
240				7,79	4,79	480	10,89	6,70	500
260				7,79	4,79	545	10,89	6,70	550
300							10,89	6,70	600
340							10,89	6,70	650
360							10,89	6,70	700
380							10,89	6,70	750
400							10,89	6,70	800

Calculated according to EN 1995-1-1, with non-predrilled holes and wood density  $\rho_k = 380 \text{ kg/m}^3$ . Design values  $F_{v,Rd}$  calculated considering  $k_{mod} = 0,8$  and  $\gamma_M = 1,3$ . Component B thickness is such that:  $B \geq L - A$ . L is the minimum screw length for achieving the respective load-carrying capacity.

**Please note:** These are planning aids. Projects must be calculated only by authorized persons.

## KONSTRUX ST COUNTERSUNK HEAD – TIMBER-TIMBER



Lateral load-carrying capacity of screws with minimum required lengths.

A [mm]	Ø 6,5 mm			Ø 8 mm			Ø 10 mm		
	$\alpha_A = 90^\circ$ $\alpha_B = 90^\circ$								
	$F_{v,Rk}$ [kN]	$F_{v,Rd}$ [kN]	L [mm]	$F_{v,Rk}$ [kN]	$F_{v,Rd}$ [kN]	L [mm]	$F_{v,Rk}$ [kN]	$F_{v,Rd}$ [kN]	L [mm]
40	2,85	1,75	80						
40	2,88	1,77	100	3,57	2,20	95			
60	3,35	2,06	120	4,46	2,75	125	5,93	3,65	125
80	3,47	2,14	140	4,93	3,04	155	6,50	4,00	155
100				5,41	3,33	195	7,08	4,36	195
120				5,58	3,43	220	7,33	4,51	220
120				5,9	3,63	245	7,66	4,71	245
140				6,38	3,93	295	8,20	5,05	270
160				6,42	3,95	330	8,48	5,22	300
160				6,42	3,95	375	8,81	5,42	330
180				6,42	3,95	375	8,90	5,48	360
200				6,42	3,95	400	8,90	5,48	400
220				6,42	3,95	430	8,90	5,48	450
240				6,42	3,95	480	8,90	5,48	500
260				6,42	3,95	545	8,90	5,48	550
300							8,90	5,48	600
340							8,90	5,48	650
360							8,90	5,48	700
380							8,90	5,48	750
400							8,90	5,48	800

Calculated according to EN 1995-1-1, with non-predrilled holes and wood density  $\rho_k = 380 \text{ kg/m}^3$ . Design values  $F_{v,Rd}$  calculated considering  $k_{mod} = 0,8$  and  $\gamma_M = 1,3$ . Component B thickness is such that:  $B \geq L - A$ . L is the minimum screw length for achieving the respective load-carrying capacity.

**Please note:** These are planning aids. Projects must be calculated only by authorized persons.

## KONSTRUX ST COUNTERSUNK HEAD – TIMBER-TIMBER

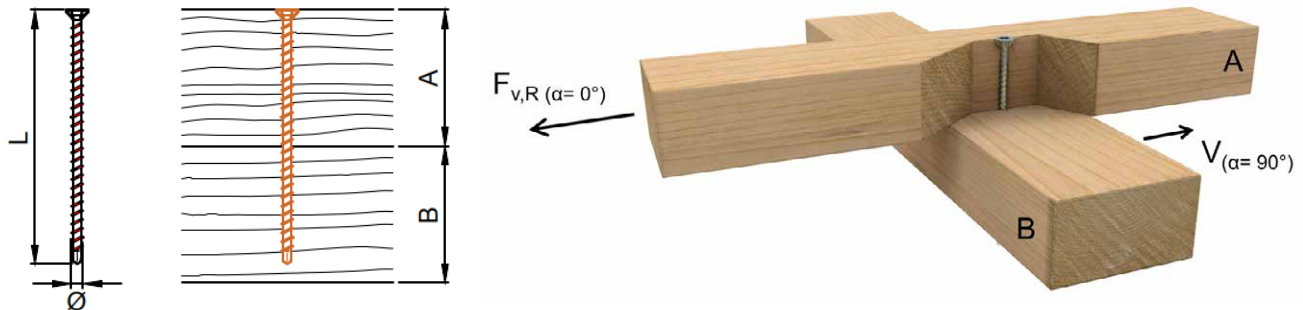

Lateral load-carrying capacity of screws with minimum required lengths.

A [mm]	Ø 6,5 mm			Ø 8 mm			Ø 10 mm		
	$\alpha_A = 0^\circ$ $\alpha_B = 90^\circ$								
	$F_{v,Rk}$ [kN]	$F_{v,Rd}$ [kN]	L [mm]	$F_{v,Rk}$ [kN]	$F_{v,Rd}$ [kN]	L [mm]	$F_{v,Rk}$ [kN]	$F_{v,Rd}$ [kN]	L [mm]
40	3,02	1,86	80						
40	3,16	1,94	100	4,28	2,63	95			
60	3,55	2,18	120	4,75	2,92	125	6,35	3,91	125
80	3,66	2,25	140	5,23	3,22	155	6,93	4,26	155
100				5,70	3,51	195	7,50	4,62	195
120				5,88	3,62	220	7,76	4,78	220
120				6,20	3,82	245	8,08	4,97	245
140				6,67	4,10	295	8,62	5,30	270
160				7,01	4,31	330	8,91	5,48	300
160				7,01	4,31	375	9,23	5,68	330
180				7,01	4,31	375	9,74	5,99	360
200				7,01	4,31	400	9,74	5,99	400
220				7,01	4,31	430	9,74	5,99	450
240				7,01	4,31	480	9,74	5,99	500
260				7,01	4,31	545	9,74	5,99	550
300							9,74	5,99	600
340							9,74	5,99	650
360							9,74	5,99	700
380							9,74	5,99	750
400							9,74	5,99	800

Calculated according to EN 1995-1-1, with non-predrilled holes and wood density  $\rho_k = 380 \text{ kg/m}^3$ . Design values  $F_{Rd}$  calculated considering  $k_{mod} = 0,8$  and  $\gamma_{M1} = 1,3$ . Component B thickness is such that:  $B \geq L - A$ . L is the minimum screw length for achieving the respective load-carrying capacity.

**Please note:** These are planning aids. Projects must be calculated only by authorized persons.



## KONSTRUX ST COUNTERSUNK HEAD – TIMBER-TIMBER

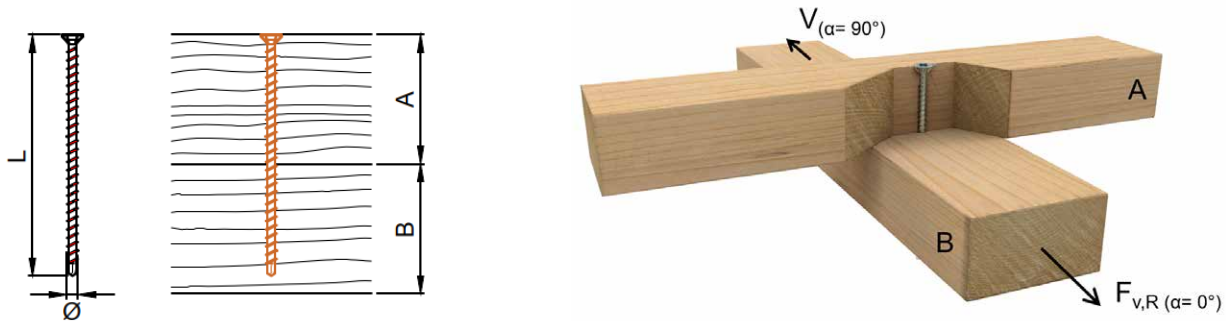

Lateral load-carrying capacity of screws with minimum required lengths.

A [mm]	Ø 6,5 mm			Ø 8 mm			Ø 10 mm		
	$\alpha_A = 90^\circ$ $\alpha_B = 0^\circ$								
	$F_{v,Rk}$ [kN]	$F_{v,Rd}$ [kN]	L [mm]	$F_{v,Rk}$ [kN]	$F_{v,Rd}$ [kN]	L [mm]	$F_{v,Rk}$ [kN]	$F_{v,Rd}$ [kN]	L [mm]
40	3,02	1,86	80						
40	3,02	1,86	100	3,76	2,32	95			
60	3,55	2,18	120	4,75	2,92	125	6,35	3,91	125
80	3,66	2,35	140	5,23	3,22	155	6,93	4,26	155
100				5,70	3,51	195	7,50	4,62	195
120				5,88	3,62	220	7,76	4,78	220
120				6,20	3,82	245	8,08	4,97	245
140				6,67	4,10	295	8,62	5,30	270
160				7,01	4,31	330	8,91	5,48	300
160				7,01	4,31	375	9,23	5,68	330
180				7,01	4,31	375	9,74	5,99	360
200				7,01	4,31	400	9,74	5,99	400
220				7,01	4,31	430	9,74	5,99	450
240				7,01	4,31	480	9,74	5,99	500
260				7,01	4,31	545	9,74	5,99	550
300							9,74	5,99	600
340							9,74	5,99	650
360							9,74	5,99	700
380							9,74	5,99	750
400							9,74	5,99	800

Calculated according to EN 1995-1-1, with non-predrilled holes and wood density  $\rho_k = 380 \text{ kg/m}^3$ . Design values  $F_{Rd}$  calculated considering  $k_{mod} = 0,8$  and  $\gamma_M = 1,3$ . Component B thickness is such that:  $B \geq L - A$ . L is the minimum screw length for achieving the respective load-carrying capacity.

**Please note:** These are planning aids. Projects must be calculated only by authorized persons.

## KONSTRUX ST COUNTERSUNK HEAD – TIMBER-TIMBER, 45° INCLINED SCREWS

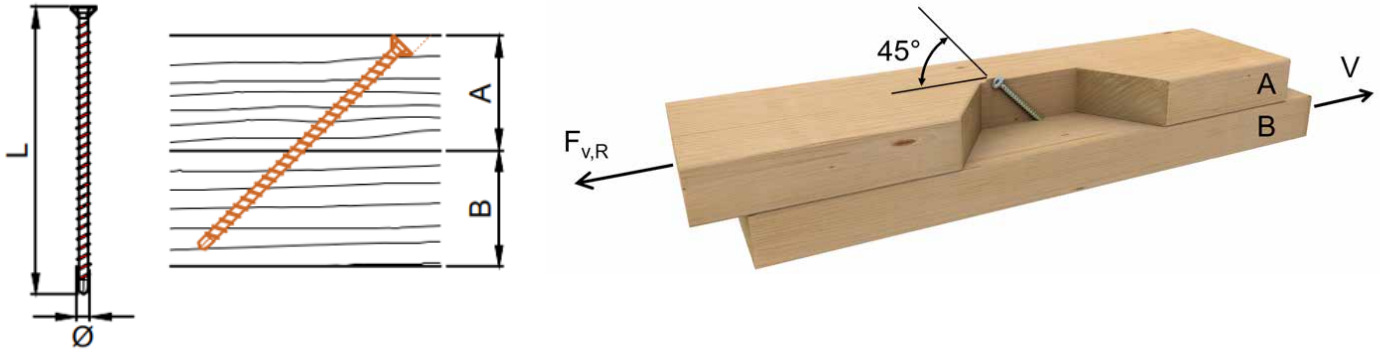

Load-carrying capacity of shear-tension screws with minimum required lengths.

A [mm]	Ø 6,5 mm			Ø 8 mm			Ø 10 mm		
	$F_{v,Rk}$ [kN]	$F_{v,Rd}$ [kN]	L [mm]	$F_{v,Rk}$ [kN]	$F_{v,Rd}$ [kN]	L [mm]	$F_{v,Rk}$ [kN]	$F_{v,Rd}$ [kN]	L [mm]
40	1,31	0,81	80						
40	2,43	1,50	100	2,57	1,58	95			
50	2,76	1,70	120	3,64	2,24	125	4,43	2,73	125
60	3,08	1,90	140	4,70	2,89	155	5,72	3,52	155
80				5,49	3,38	195	6,68	4,11	195
80				7,17	4,41	220	8,72	5,37	220
100				6,95	4,28	245	8,45	5,20	245
100				8,62	5,30	270	10,49	6,46	270
120				8,40	5,17	295	10,63	6,54	300
120				10,75	6,62	330	13,07	8,04	330
140				11,87	7,30	375	13,21	8,13	360
160				11,65	7,17	400	14,17	8,72	400
160				13,66	8,41	430	18,25	11,23	450
180				15,12	9,30	480	20,02	12,32	500
200				17,58	10,82	545	21,79	13,41	550
220							23,33	14,50	600
240							23,33	15,59	650
260							23,33	16,68	700
280							23,33	17,77	750
300							23,33	18,67	800

Calculated according to EN 1995-1-1, with non-predrilled holes and wood density  $\rho_k = 380 \text{ kg/m}^3$ . Design values  $F_{Rd}$  calculated considering  $k_{mod} = 0,8$ ,  $\gamma_M = 1,3$ , and  $\gamma_{M2} = 1,25$ . For the longer screws, design values may differ from the corresponding characteristic failure mode (withdrawal or steel tension fracture). Component B thickness is such that:  $B \geq [L \cdot \sin(\alpha) - A]$ . Depending on installation and surface conditions, design values may be increased by 25 % due to friction (see example on p. 22). L is the minimum screw length for achieving the respective load-carrying capacity. Load capacity values are not dependent on the grain orientations of components A and B.

**Please note:** These are planning aids. Projects must be calculated only by authorized persons.

## KONSTRUX ST COUNTERSUNK HEAD – STEEL-TIMBER



Axial load-carrying capacity of screws with minimum required lengths.

A [mm]	Ø 6,5 mm $t_s = 15$ mm			Ø 8 mm $t_s = 15$ mm			Ø 10 mm $t_s = 15$ mm		
	$F_{ax,Rk}$ [kN]	$F_{ax,Rd}$ [kN]	L [mm]	$F_{ax,Rk}$ [kN]	$F_{ax,Rd}$ [kN]	L [mm]	$F_{ax,Rk}$ [kN]	$F_{ax,Rd}$ [kN]	L [mm]
80	5,14	3,16	80						
100	6,73	4,14	100	7,59	4,67	95			
120	8,31	5,11	120	10,43	6,42	125	12,69	7,81	125
140	9,89	6,09	140	10,43	6,42	125	12,69	7,81	125
160				13,28	8,17	155	16,15	9,94	155
200				17,07	10,50	195	20,76	12,78	195
220				19,44	11,96	220	23,65	14,55	220
240				21,81	13,42	245	26,53	16,33	245
280				24,18	14,88	270	29,41	18,10	270
300				25,00	16,34	295	32,87	20,23	300
340				25,00	18,38	330	33,00	22,36	330
360				25,00	20,00	375	33,00	24,49	360
380				25,00	20,00	375	33,00	24,49	360
400				25,00	20,00	400	33,00	26,40	400
440				25,00	20,00	430	33,00	26,40	400
460				25,00	20,00	430	33,00	26,40	450
480				25,00	20,00	480	33,00	26,40	450
500				25,00	20,00	545	33,00	26,40	500
560							33,00	26,40	550
600							33,00	26,40	600
650							33,00	26,40	650
700							33,00	26,40	700
750							33,00	26,40	750
800							33,00	26,40	800

Calculated according to EN 1995-1-1, with non-pre-drilled holes and wood density  $\rho_k = 380$  kg/m<sup>3</sup>. Design values  $F_{ax,Rd}$  calculated considering  $k_{mod} = 0,8$  and  $\gamma_{M1} = 1,3$  and  $\gamma_{M2} = 1,25$ . For the longer screws, design values may differ from the corresponding characteristic failure mode (withdrawal or steel tension fracture). L is the minimum screw length for achieving the respective load-carrying capacity.

**Please note:** These are planning aids. Projects must be calculated only by authorized persons.

## KONSTRUX ST COUNTERSUNK HEAD – STEEL-TIMBER, 45° INCLINED SCREWS

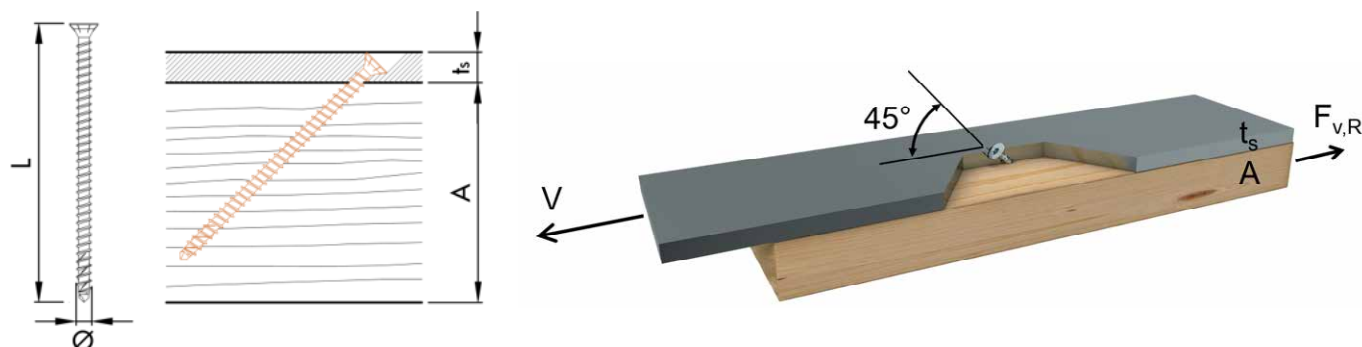

Load-carrying capacity of shear-tension screws with minimum required lengths.

A [mm]	Ø 6,5 mm $t_s = 15$ mm			Ø 8 mm $t_s = 15$ mm			Ø 10 mm $t_s = 15$ mm		
	$F_{v,Rk}$ [kN]	$F_{v,Rd}$ [kN]	L [mm]	$F_{v,Rk}$ [kN]	$F_{v,Rd}$ [kN]	L [mm]	$F_{v,Rk}$ [kN]	$F_{v,Rd}$ [kN]	L [mm]
60	3,29	2,02	80						
80	4,41	2,71	100	4,95	3,05	95			
80	5,53	3,40	120	4,95	3,05	95			
100	6,65	4,09	140	6,96	4,28	125	8,46	5,21	125
120				8,97	5,52	155	10,91	6,71	155
140				11,65	7,17	195	14,17	8,72	195
160				13,33	8,20	220	16,21	9,98	220
180				15,01	9,24	245	18,25	11,23	245
200				16,68	10,26	270	20,29	12,49	270
220				17,68	11,30	295	22,74	13,99	300
240				17,68	12,74	330	23,33	15,50	330
260				17,68	12,74	330	23,33	17,00	360
280				17,68	14,14	375	23,33	18,67	400
280				17,68	14,14	400	23,33	18,67	400
300				17,68	14,14	430	23,33	18,67	400
320				17,68	14,14	430	23,33	18,67	450
340				17,68	14,14	480	23,33	18,67	450
360				17,68	14,14	545	23,33	18,67	500
400							23,33	18,67	550
420							23,33	18,67	600
460							23,33	18,67	650
500							23,33	18,67	700
520							23,33	18,67	750
560							23,33	18,67	800

Calculated according to EN 1995-1-1, with non-predrilled holes and wood density  $\rho_k = 380$  kg/m<sup>3</sup>. Design values  $F_{v,Rd}$  calculated considering  $k_{mod} = 0,8$  and  $\gamma_M = 1,3$  and  $\gamma_{M2} = 1,25$ . For the longer screws, design values may differ from the corresponding characteristic failure mode (withdrawal or steel tension fracture). L is the minimum screw length for achieving the respective load-carrying capacity. Load capacity values are not dependent on the grain orientation of wood component.

**Please note:** These are planning aids. Projects must be calculated only by authorized persons.

## KONSTRUX ST COUNTERSUNK HEAD – STEEL-TIMBER, THICK PLATE

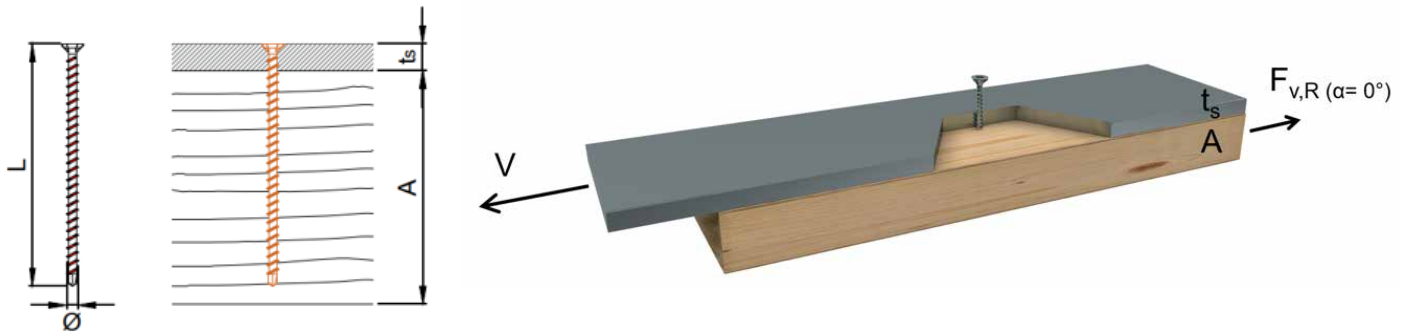

Lateral load-carrying capacity of screws with minimum required lengths.

A [mm]	Ø 6,5 mm $t_s = 15$ mm			Ø 8 mm $t_s = 15$ mm			Ø 10 mm $t_s = 15$ mm		
	$\alpha_A = 0^\circ$								
	$F_{v,Rk}$ [kN]	$F_{v,Rd}$ [kN]	L [mm]	$F_{v,Rk}$ [kN]	$F_{v,Rd}$ [kN]	L [mm]	$F_{v,Rk}$ [kN]	$F_{v,Rd}$ [kN]	L [mm]
80	5,16	3,18	80						
100	5,56	3,42	100	7,40	4,56	95			
120	5,95	3,66	120	8,12	4,99	125	10,88	6,69	125
140	6,35	3,91	140	8,12	4,99	125	10,88	6,69	125
160				8,83	5,53	155	11,74	7,22	155
200				9,77	6,02	195	12,89	7,93	195
220				10,37	6,38	220	13,61	8,38	220
240				10,96	6,74	245	14,34	8,82	245
280				11,01	6,78	270	15,06	9,27	270
300				11,01	6,78	295	15,41	9,48	300
340				11,01	6,78	330	15,41	9,48	330
360				11,01	6,78	330	15,41	9,48	360
380				11,01	6,78	375	15,41	9,48	360
400				11,01	6,78	400	15,41	9,48	400
440				11,01	6,78	430	15,41	9,48	400
460				11,01	6,78	430	15,41	9,48	450
480				11,01	6,78	480	15,41	9,48	450
500				11,01	6,78	480	15,41	9,48	500
560				11,01	6,78	545	15,41	9,48	550
600							15,41	9,48	600
650							15,41	9,48	650
700							15,41	9,48	700
750							15,41	9,48	750
800							15,41	9,48	800

Calculated according to EN 1995-1-1, with non-predrilled holes and wood density  $\rho_k = 380$  kg/m<sup>3</sup>. Design values  $F_{v,Rd}$  calculated considering  $k_{mod} = 0,8$  and  $\gamma_M = 1,3$ . For the longer screws, the design and characteristic values may not come from the same failure mode. L is the minimum screw length for achieving the respective load-carrying capacity.

**Please note:** These are planning aids. Projects must be calculated only by authorized persons.

## KONSTRUX ST COUNTERSUNK HEAD – STEEL-TIMBER, THICK PLATE



Lateral load-carrying capacity of screws with minimum required lengths.

A [mm]	Ø 6,5 mm $t_s = 15$ mm			Ø 8 mm $t_s = 15$ mm			Ø 10 mm $t_s = 15$ mm		
	$\alpha_A = 90^\circ$								
	$F_{v,Rk}$ [kN]	$F_{v,Rd}$ [kN]	L [mm]	$F_{v,Rk}$ [kN]	$F_{v,Rd}$ [kN]	L [mm]	$F_{v,Rk}$ [kN]	$F_{v,Rd}$ [kN]	L [mm]
80	4,51	2,77	80						
100	4,90	3,02	100	6,44	3,96	95			
120	5,30	3,26	120	7,15	4,40	125	9,46	5,82	125
140	5,70	3,50	140	7,15	4,40	125	9,46	5,82	125
160				7,86	4,84	155	10,33	6,35	155
200				8,81	5,42	195	11,48	7,06	195
220				9,08	5,59	220	12,20	7,51	220
240				9,08	5,59	245	12,58	7,74	245
280				9,08	5,59	270	12,58	7,74	270
300				9,08	5,59	295	12,58	7,74	300
340				9,08	5,59	330	12,58	7,74	330
360				9,08	5,59	330	12,58	7,74	360
380				9,08	5,59	375	12,58	7,74	360
400				9,08	5,59	400	12,58	7,74	400
440				9,08	5,59	430	12,58	7,74	400
460				9,08	5,59	430	12,58	7,74	450
480				9,08	5,59	480	12,58	7,74	450
500				9,08	5,59	480	12,58	7,74	500
560				9,08	5,59	545	12,58	7,74	550
600							12,58	7,74	600
650							12,58	7,74	650
700							12,58	7,74	700
750							12,58	7,74	750
800							12,58	7,74	800

Calculated according to EN 1995-1-1, with non-predrilled holes and wood density  $\rho_k = 380 \text{ kg/m}^3$ . Design values  $F_{v,Rd}$  calculated considering  $k_{mod} = 0,8$  and  $\gamma_{M1} = 1,3$ . L is the minimum screw length for achieving the respective load-carrying capacity.

**Please note:** These are planning aids. Projects must be calculated only by authorized persons.

## KONSTRUX AG COUNTERSUNK HEAD – TIMBER-TIMBER

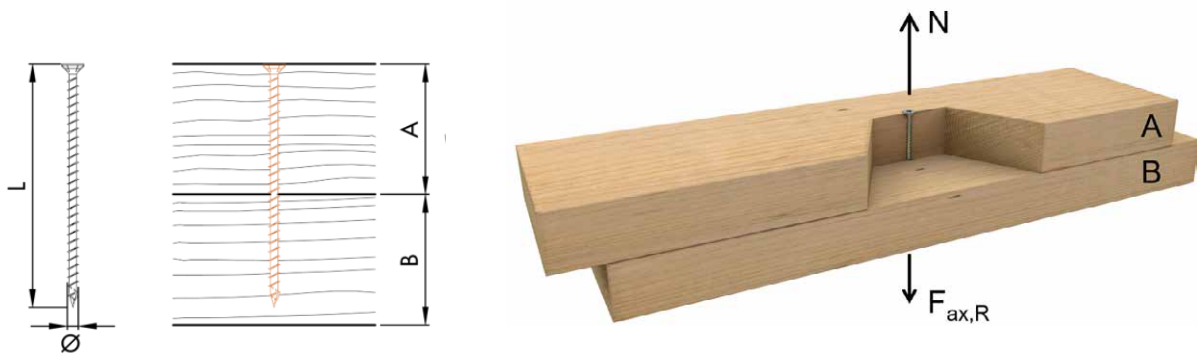

Axial load-carrying capacities of screws with minimum required lengths.

		Ø 11,3 mm	
A [mm]	L [mm]	$F_{ax,Rk}$ [kN]	$F_{ax,Rd}$ [kN]
160	300	18,25	11,23
180	340	20,85	12,83
200	380	23,46	14,44
220	420	26,07	16,04
240	460	28,67	17,65
260	500	31,28	19,25
280	540	33,89	20,86
300	580	36,49	22,46
320	620	39,10	24,06
340	660	41,71	25,67
360	700	44,32	27,27
380	750	48,23	29,68
400	800	50,00	31,52
460	900	50,00	35,29
500	1000	50,00	39,54

Calculated according to EN 1995-1-1, with non-pre-drilled holes and wood density  $\rho_k = 380 \text{ kg/m}^3$ . Design values  $F_{Rd}$  calculated considering  $k_{mod} = 0,8$  and  $\gamma_M = 1,3$  and  $\gamma_{M2} = 1,25$ . For the longer screws, design values may differ from the corresponding characteristic failure mode (withdrawal or steel tension fracture). Component B thickness is such that:  $B \geq L - A$ . L is the minimum screw length for achieving the respective load-carrying capacity.

**Please note:** These are planning aids. Projects must be calculated only by authorized persons.

## KONSTRUX AG COUNTERSUNK HEAD – TIMBER-TIMBER

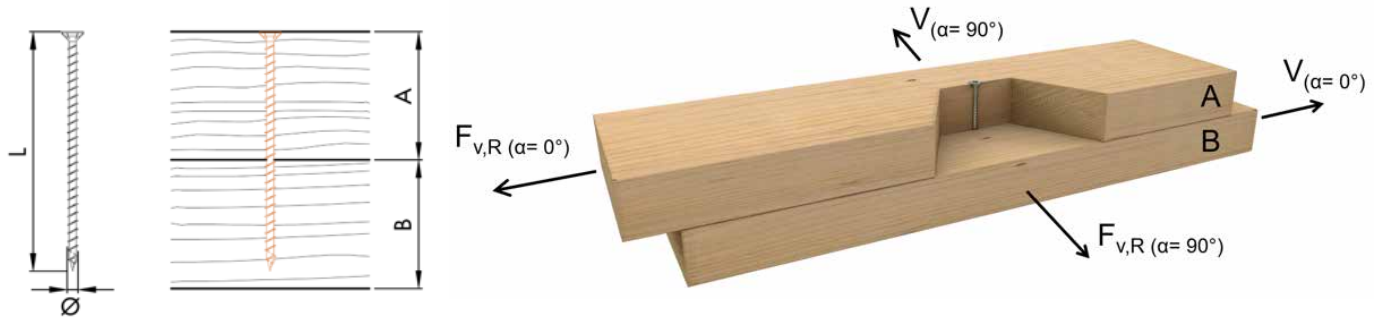

Lateral load-carrying capacities of screws with minimum required lengths.

		Ø 11,3 mm			
		$\alpha_A = 0^\circ$ $\alpha_B = 0^\circ$		$\alpha_A = 90^\circ$ $\alpha_B = 90^\circ$	
A [mm]	L [mm]	$F_{v,Rk}$ [kN]	$F_{v,Rd}$ [kN]	$F_{v,Rk}$ [kN]	$F_{v,Rd}$ [kN]
160	300	12,17	7,49	10,73	6,60
180	340	12,82	7,89	11,38	7,00
200	380	13,47	8,29	12,03	7,40
220	420	14,12	8,69	12,34	7,59
240	460	14,77	9,09	12,34	7,59
260	500	15,21	9,36	12,34	7,59
280	540	15,21	9,36	12,34	7,59
300	580	15,21	9,36	12,34	7,59
320	620	15,21	9,36	12,34	7,59
340	660	15,21	9,36	12,34	7,59
360	700	15,21	9,36	12,34	7,59
380	750	15,21	9,36	12,34	7,59
400	800	15,21	9,36	12,34	7,59
460	900	15,21	9,36	12,34	7,59
500	1000	15,21	9,36	12,34	7,59

Calculated according to EN 1995-1-1, with non-predrilled holes and wood density  $\rho_k = 380 \text{ kg/m}^3$ . Design values  $F_{Rd}$  calculated considering  $k_{mod} = 0,8$  and  $\gamma_M = 1,3$ . Component B thickness is such that:  $B \geq L - A$ . L is the minimum screw length for achieving the respective load-carrying capacity.

**Please note:** These are planning aids. Projects must be calculated only by authorized persons.



## KONSTRUX AG COUNTERSUNK HEAD – TIMBER-TIMBER

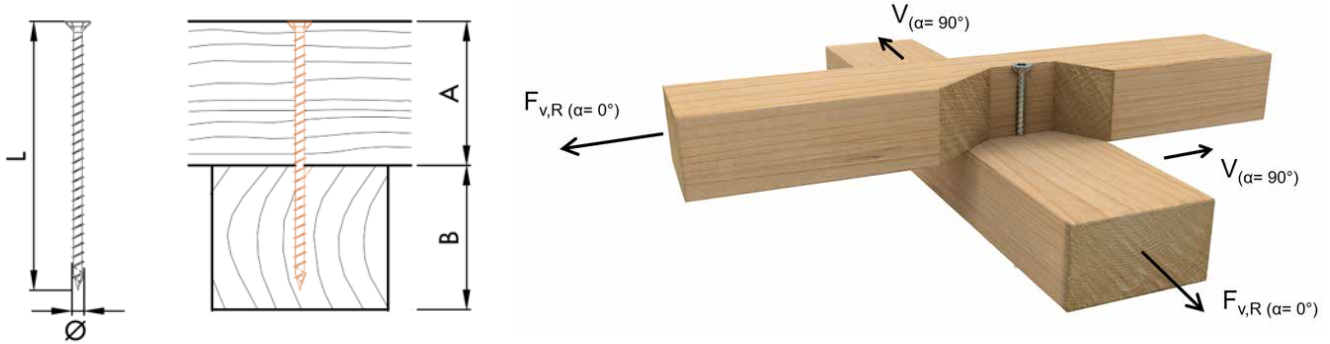

Lateral load-carrying capacities of screws with minimum required lengths.

		Ø 11,3 mm			
		$\alpha_A = 0^\circ$ $\alpha_B = 90^\circ$		$\alpha_A = 90^\circ$ $\alpha_B = 0^\circ$	
A [mm]	L [mm]	$F_{v,Rk}$ [kN]	$F_{v,Rd}$ [kN]	$F_{v,Rk}$ [kN]	$F_{v,Rd}$ [kN]
160	300	11,34	6,98	11,34	6,98
180	340	11,99	7,38	11,99	7,38
200	380	12,64	7,78	12,64	7,78
220	420	13,29	8,18	13,29	8,18
240	460	13,55	8,34	13,55	8,34
260	500	13,55	8,34	13,55	8,34
280	540	13,55	8,34	13,55	8,34
300	580	13,55	8,34	13,55	8,34
320	620	13,55	8,34	13,55	8,34
340	660	13,55	8,34	13,55	8,34
360	700	13,55	8,34	13,55	8,34
380	750	13,55	8,34	13,55	8,34
400	800	13,55	8,34	13,55	8,34
460	900	13,55	8,34	13,55	8,34
500	1000	13,55	8,34	13,55	8,34

Calculated according to EN 1995-1-1, with non-predrilled holes and wood density  $\rho_k = 380 \text{ kg/m}^3$ . Design values  $F_{v,Rd}$  calculated considering  $k_{mod} = 0,8$  and  $\gamma_M = 1,3$ . Component B thickness is such that:  $B \geq L - A$ . L is the minimum screw length for achieving the respective load-carrying capacity.

**Please note:** These are planning aids. Projects must be calculated only by authorized persons.

## KONSTRUX AG COUNTERSUNK HEAD – TIMBER-TIMBER

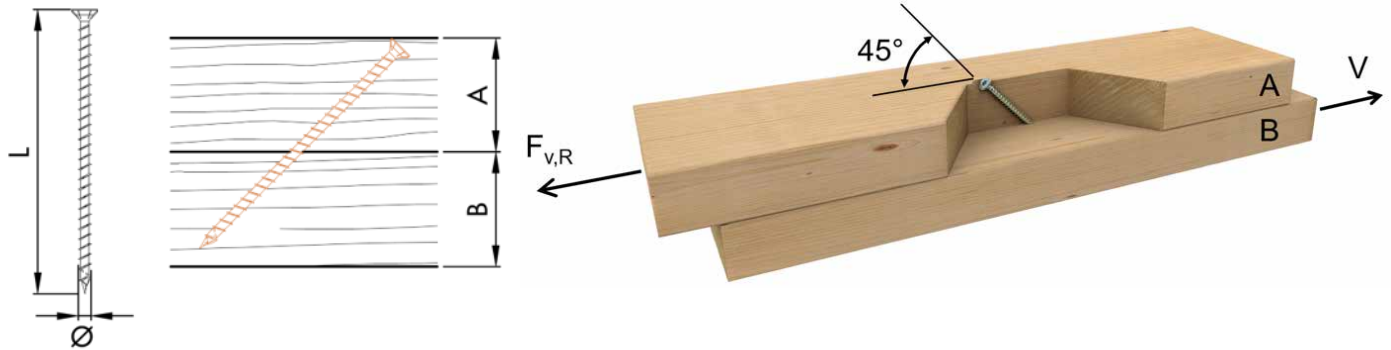

Load-carrying capacity of shear-tension screws with minimum required lengths.

		Ø 11,3 mm		
A [mm]	L [mm]	$F_{v,Rk}$ [kN]	$F_{v,Rd}$ [kN]	
120	300	12,01	7,39	
140	340	13,09	8,06	
140	380	16,77	10,32	
160	420	17,85	10,98	
180	460	18,93	11,65	
180	500	22,62	13,92	
200	540	23,70	14,58	
220	580	24,78	15,25	
220	620	28,47	17,52	
240	660	29,55	18,18	
260	700	30,63	18,85	
280	750	32,63	20,08	
300	800	34,63	21,31	
320	900	35,36	25,38	
360	1000	35,36	27,84	

Calculated according to EN 1995-1-1, with non-predrilled holes and wood density  $\rho_k = 380 \text{ kg/m}^3$ . Design values  $F_{Rd}$  calculated considering  $k_{mod} = 0,8$ ,  $\gamma_M = 1,3$ , and  $\gamma_{M2} = 1,25$ . For the longer screws, design values may differ from the corresponding characteristic failure mode (withdrawal or steel tension fracture). Component B thickness is such that:  $B \geq [L \cdot \sin(\alpha) - A]$ . Depending on installation and surface conditions, design values may be increased by 25 % due to friction (see example on p. 22). L is the minimum screw length for achieving the respective load-carrying capacity. Load capacity values are not dependent on the grain orientations of components A and B.

**Please note:** These are planning aids. Projects must be calculated only by authorized persons.

## KONSTRUX AG COUNTERSUNK HEAD – STEEL-TIMBER, THICK PLATE

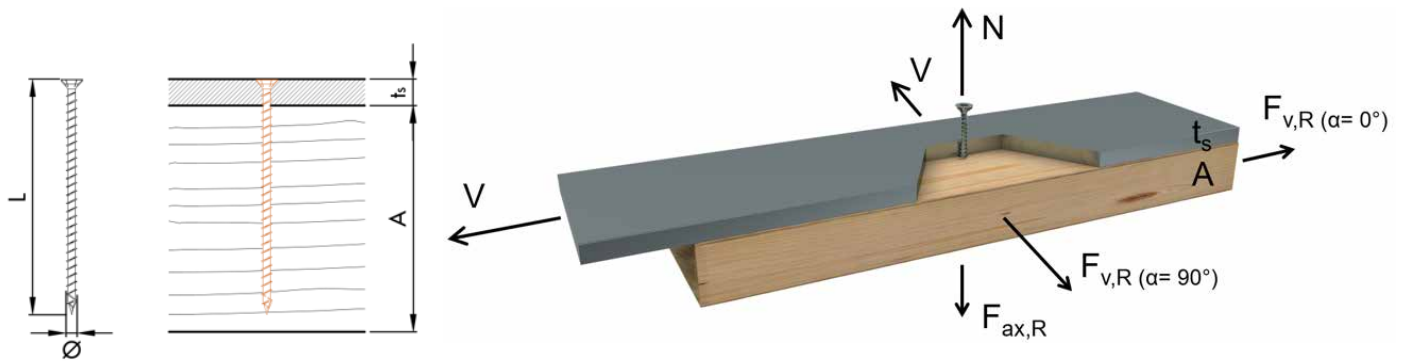

Load-carrying capacities of screws with minimum required lengths.

		Ø 11,3 mm t <sub>s</sub> = 20 mm					
		–		α <sub>A</sub> = 0°		α <sub>A</sub> = 90°	
A [mm]	L [mm]	F <sub>ax,Rk</sub> [kN]	F <sub>ax,Rd</sub> [kN]	F <sub>ax,Rk</sub> [kN]	F <sub>ax,Rd</sub> [kN]	F <sub>ax,Rk</sub> [kN]	F <sub>ax,Rd</sub> [kN]
300	300	36,49	22,46	19,88	12,23	17,45	10,74
340	340	41,71	25,67	21,18	13,03	17,45	10,74
380	380	46,92	28,87	21,51	13,24	17,45	10,74
420	420	50,00	32,48	21,51	13,24	17,45	10,74
460	460	50,00	35,69	21,51	13,24	17,45	10,74
500	500	50,00	39,54	21,51	13,24	17,45	10,74
540	540	50,00	39,54	21,51	13,24	17,45	10,74
580	580	50,00	39,54	21,51	13,24	17,45	10,74
620	620	50,00	39,54	21,51	13,24	17,45	10,74
660	660	50,00	39,54	21,51	13,24	17,45	10,74
700	700	50,00	39,54	21,51	13,24	17,45	10,74
740	750	50,00	39,54	21,51	13,24	17,45	10,74
800	800	50,00	39,54	21,51	13,24	17,45	10,74
900	900	50,00	39,54	21,51	13,24	17,45	10,74
1000	1000	50,00	39,54	21,51	13,24	17,45	10,74

Calculated according to EN 1995-1-1, with non-predrilled holes and wood density  $\rho_k = 380 \text{ kg/m}^3$ . Design values  $F_{Rd}$  calculated considering  $k_{mod} = 0,8$  and  $\gamma_m = 1,3$ . Component B thickness is such that:  $B \geq L - A$ . L is the minimum screw length for achieving the respective load-carrying capacity.

**Please note:** These are planning aids. Projects must be calculated only by authorized persons.

## KONSTRUX AG COUNTERSUNK HEAD – STEEL-TIMBER

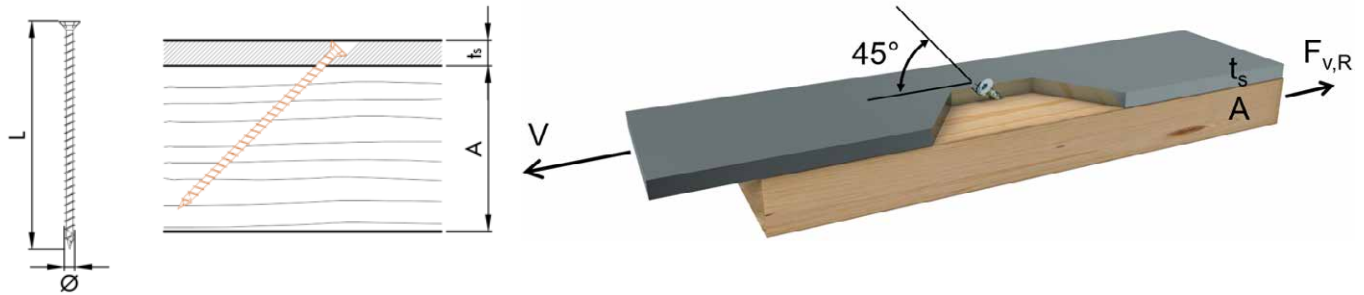

Load-carrying capacity of shear-tension screws with minimum required lengths.

		Ø 11,3 mm t <sub>s</sub> = 20 mm		
A [mm]	L [mm]	F <sub>v,Rk</sub> [kN]	F <sub>v,Rd</sub> [kN]	
220	300	25,04	15,41	
240	340	28,73	17,68	
260	380	32,42	19,95	
300	420	35,36	22,22	
320	460	35,36	24,49	
360	500	35,36	26,76	
380	540	35,36	28,28	
420	580	35,36	28,28	
440	620	35,36	28,28	
460	660	35,36	28,28	
500	700	35,36	28,28	
540	750	35,36	28,28	
560	800	35,36	28,28	
640	900	35,36	28,28	
700	1000	35,36	28,28	

Calculated according to EN 1995-1-1, with non-predrilled holes and wood density  $\rho_k = 380 \text{ kg/m}^3$ . Design values  $F_{Rd}$  calculated considering  $k_{mod} = 0,8$  and  $\gamma_M = 1,3$  and  $\gamma_{M2} = 1,25$ . For the longer screws, design values may differ from the corresponding characteristic failure mode (withdrawal or steel tension fracture). L is the minimum screw length for achieving the respective load-carrying capacity. Load capacity values are not dependent on the grain orientation of wood component.

**Please note:** These are planning aids. Projects must be calculated only by authorized persons.

## KONSTRUX ST CYLINDER HEAD – TIMBER-TIMBER

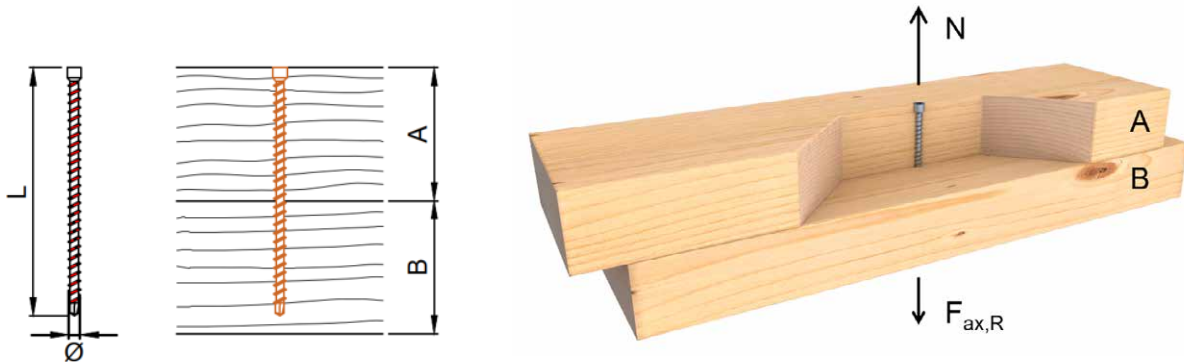

Axial load-carrying capacity of screws with minimum required lengths.

A [mm]	Ø 6,5 mm			Ø 8 mm			Ø 10 mm		
	$F_{ax,Rk}$ [kN]	$F_{ax,Rd}$ [kN]	L [mm]	$F_{ax,Rk}$ [kN]	$F_{ax,Rd}$ [kN]	L [mm]	$F_{ax,Rk}$ [kN]	$F_{ax,Rd}$ [kN]	L [mm]
40	2,73	1,68	80						
60	3,17	1,95	100						
60	4,31	2,65	120						
80	4,75	2,92	140						
80	5,90	3,63	160	6,97	4,29	155			
100	7,48	4,60	195	8,87	5,46	195			
120				9,48	5,83	220			
120				10,76	6,62	245			
140				12,66	7,79	295			
160				14,56	8,96	330	16,15	9,94	300
160				14,56	8,96	375	17,71	10,90	330
180				16,45	10,13	375	20,01	12,32	360
200				18,35	11,29	400	22,32	13,73	400
220				19,92	12,26	430	24,63	15,15	450
240				22,14	13,63	480	26,93	16,57	500
260				24,04	14,79	530	29,24	17,99	550
300				25,00	16,34	580	33,00	20,83	600

Calculated according to EN 1995-1-1, with non-predrilled holes and wood density  $\rho_k = 380 \text{ kg/m}^3$ . Design values  $F_{Rd}$  calculated considering  $k_{mod} = 0,8$  and  $\gamma_M = 1,3$  and  $\gamma_{M2} = 1,25$ . For the longer screws, design values may differ from the corresponding characteristic failure mode (withdrawal or steel tension fracture). Component B thickness is such that:  $B \geq L - A$ . L is the minimum screw length for achieving the respective load-carrying capacity.

**Please note:** These are planning aids. Projects must be calculated only by authorized persons.

## KONSTRUX ST CYLINDER HEAD – TIMBER-TIMBER

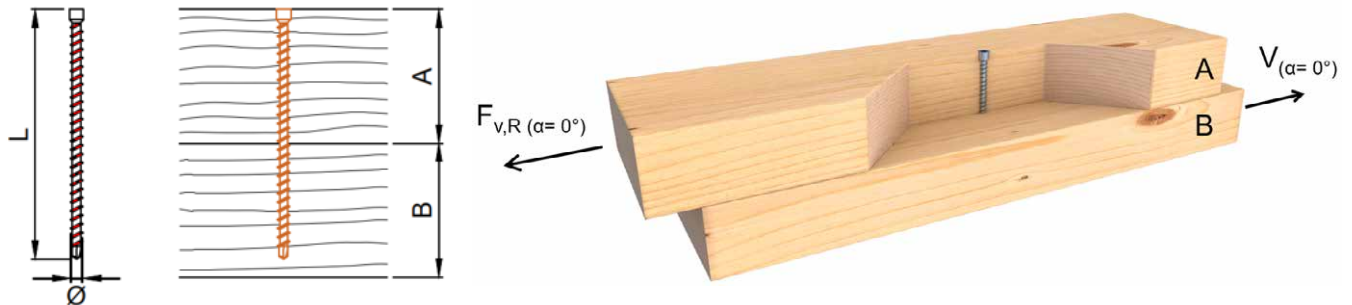

Lateral load-carrying capacity of screws with minimum required lengths.

A [mm]	Ø 6,5 mm			Ø 8 mm			Ø 10 mm		
	$F_{v,Rk}$ [kN]	$F_{v,Rd}$ [kN]	L [mm]	$F_{v,Rk}$ [kN]	$F_{v,Rd}$ [kN]	L [mm]	$F_{v,Rk}$ [kN]	$F_{v,Rd}$ [kN]	L [mm]
40	3,42	2,10	80						
60	3,53	2,17	100						
60	3,82	2,35	120						
80	3,93	2,42	140						
80	4,22	2,60	160	5,62	3,46	155			
100	4,62	2,84	195	6,10	3,75	195			
120				6,27	3,86	220			
120				6,59	4,06	245			
140				7,06	4,34	295			
160				7,53	4,63	330	9,48	5,83	300
160				7,53	4,63	330	9,87	6,07	330
180				7,79	4,79	375	10,45	6,43	360
200				7,79	4,79	400	10,89	6,70	400
220				7,79	4,79	430	10,89	6,70	450
240				7,79	4,79	480	10,89	6,70	500
260				7,79	4,79	530	10,89	6,70	550
300				7,79	4,79	580	10,89	6,70	600

Calculated according to EN 1995-1-1, with non-predrilled holes and wood density  $\rho_k = 380 \text{ kg/m}^3$ . Design values  $F_{Rd}$  calculated considering  $k_{mod} = 0,8$  and  $\gamma_M = 1,3$ . Component B thickness is such that:  $B \geq L - A$ . L is the minimum screw length for achieving the respective load-carrying capacity.

**Please note:** These are planning aids. Projects must be calculated only by authorized persons.

## KONSTRUX ST CYLINDER HEAD – TIMBER-TIMBER

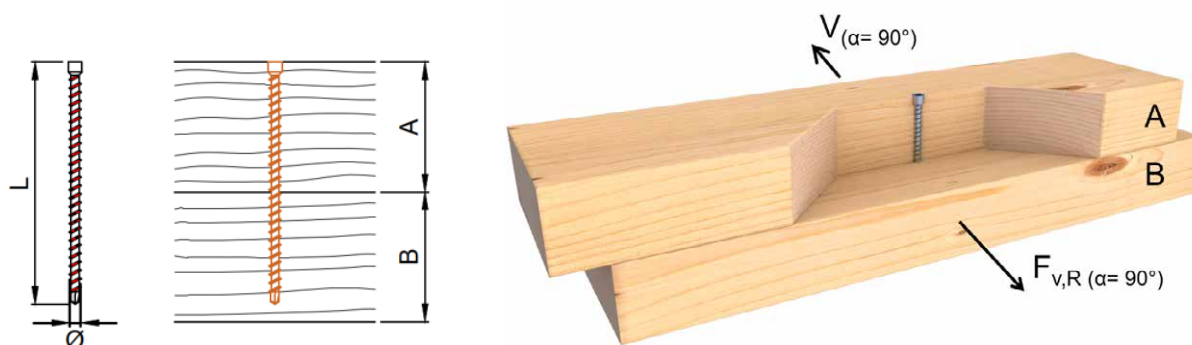

Lateral load-carrying capacity of screws with minimum required lengths.

A [mm]	Ø 6,5 mm			Ø 8 mm			Ø 10 mm		
	$F_{v,Rk}$ [kN]	$F_{v,Rd}$ [kN]	L [mm]	$F_{v,Rk}$ [kN]	$F_{v,Rd}$ [kN]	L [mm]	$F_{v,Rk}$ [kN]	$F_{v,Rd}$ [kN]	L [mm]
40	2,85	1,75	80						
60	3,00	1,85	100						
60	3,36	2,07	120						
80	3,47	2,14	140						
80	3,75	2,31	160	4,93	3,04	155			
100	4,16	2,56	195	5,41	3,33	195			
120				5,58	3,43	220			
120				6,38	3,93	245			
140				6,42	3,95	295			
160				6,42	3,95	330	8,48	5,22	300
160				6,42	3,95	330	8,87	5,46	330
180				6,42	3,95	375	8,90	5,48	360
200				6,42	3,95	400	8,90	5,48	400
220				6,42	3,95	430	8,90	5,48	450
240				6,42	3,95	480	8,90	5,48	500
260				6,42	3,95	530	8,90	5,48	550
300				6,42	3,95	580	8,90	5,48	600

Calculated according to EN 1995-1-1, with non-predrilled holes and wood density  $\rho_k = 380 \text{ kg/m}^3$ . Design values  $F_{Rd}$  calculated considering  $k_{mod} = 0,8$  and  $\gamma_M = 1,3$ . Component B thickness is such that:  $B \geq L - A$ . L is the minimum screw length for achieving the respective load-carrying capacity.

**Please note:** These are planning aids. Projects must be calculated only by authorized persons.

## KONSTRUX ST CYLINDER HEAD – TIMBER-TIMBER

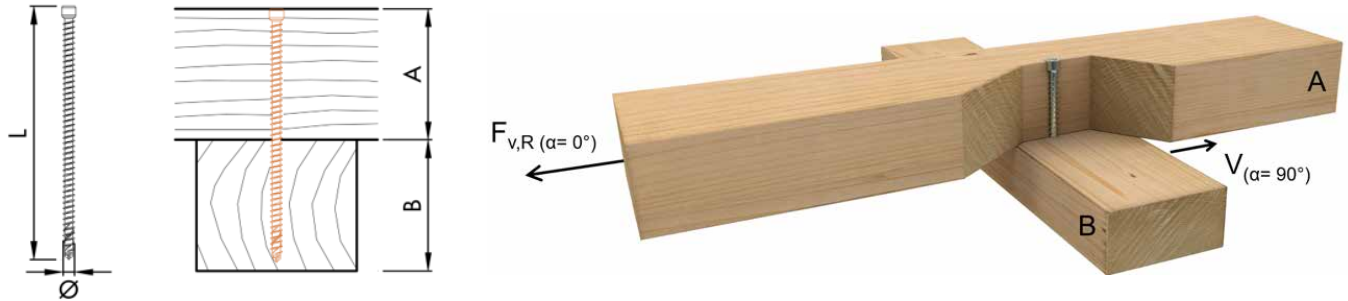

Lateral load-carrying capacity of screws with minimum required lengths.

A [mm]	Ø 6,5 mm			Ø 8 mm			Ø 10 mm		
	$\alpha_A = 0^\circ$ $\alpha_B = 90^\circ$								
	$F_{v,Rk}$ [kN]	$F_{v,Rd}$ [kN]	L [mm]	$F_{v,Rk}$ [kN]	$F_{v,Rd}$ [kN]	L [mm]	$F_{v,Rk}$ [kN]	$F_{v,Rd}$ [kN]	L [mm]
40	3,03	1,86	80						
60	3,14	1,93	100						
60	3,56	2,19	120						
80	3,66	2,25	140						
80	3,95	2,43	160	5,23	3,22	155			
100	4,35	2,68	195	5,70	3,51	195			
120				5,58	3,43	220			
120				6,20	3,82	245			
140				7,01	4,31	295			
160				7,01	4,31	330	8,91	5,48	300
160				7,01	4,31	375	9,30	5,72	330
180				7,01	4,31	375	9,74	5,99	360
200				7,01	4,31	400	9,74	5,99	400
220				7,01	4,31	430	9,74	5,99	450
240				7,01	4,31	480	9,74	5,99	500
260				7,01	4,31	530	9,74	5,99	550
300				7,01	4,31	580	9,74	5,99	600

Calculated according to EN 1995-1-1, with non-pre-drilled holes and wood density  $\rho_k = 380 \text{ kg/m}^3$ . Design values  $F_{v,Rd}$  calculated considering  $k_{mod} = 0,8$  and  $\gamma_M = 1,3$ . Component B thickness is such that:  $B \geq L - A$ . L is the minimum screw length for achieving the respective load-carrying capacity.

**Please note:** These are planning aids. Projects must be calculated only by authorized persons.



## KONSTRUX ST CYLINDER HEAD – TIMBER-TIMBER

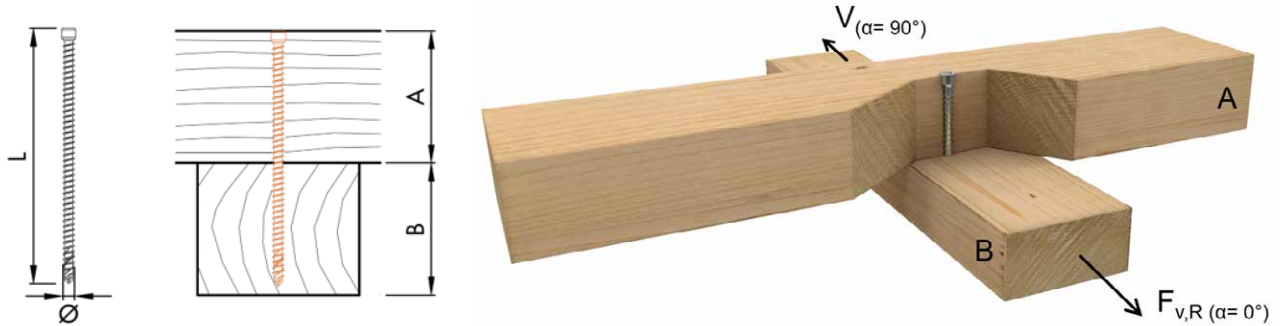

Lateral load-carrying capacity of screws with minimum required lengths.

A [mm]	Ø 6,5 mm			Ø 8 mm			Ø 10 mm		
	$F_{v,Rk}$ [kN]	$F_{v,Rd}$ [kN]	L [mm]	$F_{v,Rk}$ [kN]	$F_{v,Rd}$ [kN]	L [mm]	$F_{v,Rk}$ [kN]	$F_{v,Rd}$ [kN]	L [mm]
40	3,03	1,86	80						
60	3,14	1,93	100						
60	3,56	2,19	120						
80	3,66	2,25	140						
80	3,95	2,43	160	5,23	3,22	155			
100	4,35	2,68	195	5,70	3,51	195			
120				5,88	3,62	220			
120				6,20	3,82	245			
140				6,67	4,10	295			
160				7,01	4,31	330	8,91	5,48	300
160				7,01	4,31	375	9,30	5,72	330
180				7,01	4,31	375	9,74	5,99	360
200				7,01	4,31	400	9,74	5,99	400
220				7,01	4,31	430	9,74	5,99	450
240				7,01	4,31	480	9,74	5,99	500
260				7,01	4,31	530	9,74	5,99	550
300				7,01	4,31	580	9,74	5,99	600

Calculated according to EN 1995-1-1, with non-predrilled holes and wood density  $\rho_k = 380 \text{ kg/m}^3$ . Design values  $F_{Rd}$  calculated considering  $k_{mod} = 0,8$  and  $\gamma_M = 1,3$ . Component B thickness is such that:  $B \geq L - A$ . L is the minimum screw length for achieving the respective load-carrying capacity.

**Please note:** These are planning aids. Projects must be calculated only by authorized persons.

## KONSTRUX ST CYLINDER HEAD – TIMBER-TIMBER, 45° INCLINED SCREWS

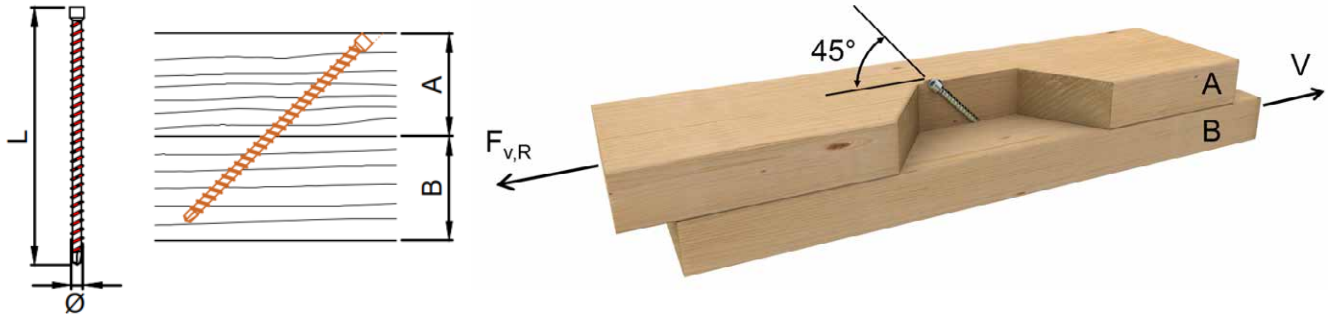

Load-carrying capacity of shear-tension screws with minimum required lengths.

A [mm]	Ø 6,5 mm			Ø 8 mm			Ø 10 mm		
	$F_{v,Rk}$ [kN]	$F_{v,Rd}$ [kN]	L [mm]	$F_{v,Rk}$ [kN]	$F_{v,Rd}$ [kN]	L [mm]	$F_{v,Rk}$ [kN]	$F_{v,Rd}$ [kN]	L [mm]
60	4,21	2,59	160	4,70	2,89	155			
80	4,58	2,82	195	5,49	3,38	195			
80				7,17	4,41	220			
100				6,95	4,28	245			
120				8,40	5,17	295	10,63	6,54	300
120				10,75	6,62	330	13,07	8,04	330
140				11,87	7,30	375	13,21	8,13	360
160				11,65	7,17	400	14,17	8,72	400
160				13,66	8,41	430	18,25	11,23	450
180				15,12	9,30	480	20,02	12,32	500
200				16,57	10,20	530	21,79	13,41	550
220				17,68	11,10	580	23,33	14,50	600

Calculated according to EN 1995-1-1, with non-predrilled holes and wood density  $\rho_k = 380 \text{ kg/m}^3$ . Design values  $F_{Rd}$  calculated considering  $k_{mod} = 0,8$ ,  $\gamma_M = 1,3$ , and  $\gamma_{M2} = 1,25$ . For the longer screws, design values may differ from the corresponding characteristic failure mode (withdrawal or steel tension fracture). Component B thickness is such that:  $B \geq [L \cdot \sin(\alpha) - A]$ . Depending on installation and surface conditions, design values may be increased by 25 % due to friction (see example on p. 22). L is the minimum screw length for achieving the respective load-carrying capacity. Load capacity values are not dependent on the grain orientations of components A and B.

**Please note:** These are planning aids. Projects must be calculated only by authorized persons.

## KONSTRUX ST CYLINDER HEAD / COUNTERSUNK HEAD – TIMBER-TIMBER, CROSS SCREWS

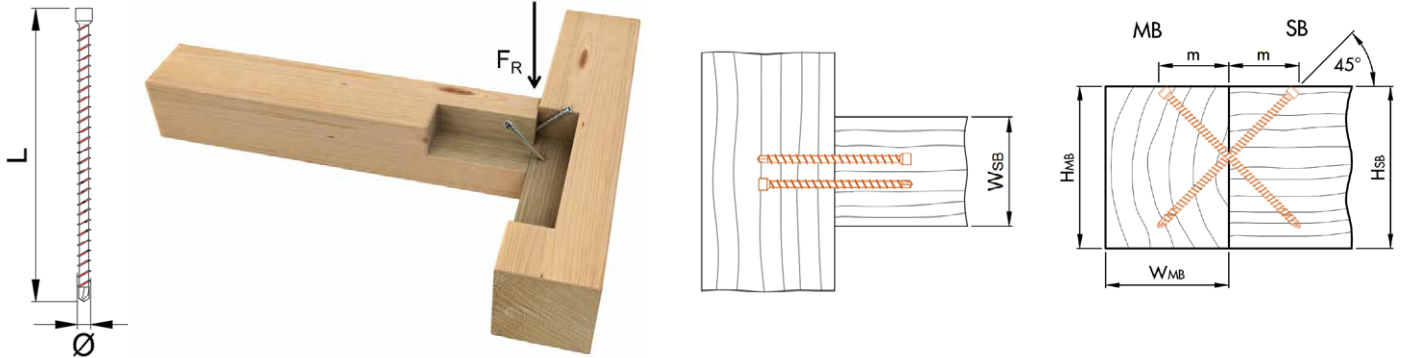

Load-carrying capacity of screws with minimum required lengths.

Ø x L [mm]	min. W <sub>SB</sub> [mm]	min. H <sub>SB</sub> [mm]	min. W <sub>MB</sub> [mm]	min. H <sub>MB</sub> [mm]	F <sub>R,d</sub> [kN]		Pair [n]
					k <sub>mod</sub> = 0,8	k <sub>mod</sub> = 0,9	
6,5 x 195	60	160	80	160	6,72	7,55	1
	100				12,53	14,10	2
	120				18,05	20,31	3
8,0 x 245	80	200	100	200	10,11	11,37	1
	100				18,87	21,23	2
	140				27,18	30,57	3
8,0 x 295	80	220	120	220	12,17	13,70	1
	100				22,72	25,56	2
	140				32,72	36,81	3
8,0 x 330	80	260	140	260	13,62	15,32	1
	100				25,41	28,59	2
	140				36,60	41,18	3
8,0 x 375	80	280	160	280	15,48	17,41	1
	100				28,88	32,49	2
	140				41,60	46,80	3
8,0 x 400	80	300	160	300	16,51	17,44	1
	100				30,80	32,55	2
	140				44,37	46,88	3
8,0 x 430	80	320	180	320	17,44	17,44	1
	100				32,55	32,55	2
	140				46,88	46,88	3
8,0 x 480	80	360	180	360	17,44	17,44	1
	100				32,55	32,55	2
	140				46,88	46,88	3

Calculated according to EN 1995-1-1 and ETA-11/0024, with non-predrilled holes and wood density  $\rho_k = 380 \text{ kg/m}^3$ . Design values  $F_{R,d}$  calculated considering  $k_{mod} = 0,8$ ,  $k_{mod} = 0,9$ ,  $\gamma_M = 1,3$  (connections),  $\gamma_{M2} = 1,25$  (tensile fracture), and  $\gamma_{M2} = 1,0$  (instability failure). L is the minimum screw length for achieving the respective load-carrying capacity. Calculation of  $F_{V,Rd} = 2 \cdot n_{pair}^{0,9} \cdot \sin 45^\circ \cdot \min. [F_{ax,cl,Rd}; F_{tens,d}; F_{kj,Rd}]$ .

**Please note:** These are planning aids. Projects must be calculated only by authorized persons.

## KONSTRUX ST CYLINDER HEAD / COUNTERSUNK HEAD – TIMBER-TIMBER, CROSS SCREWS (CONT.)

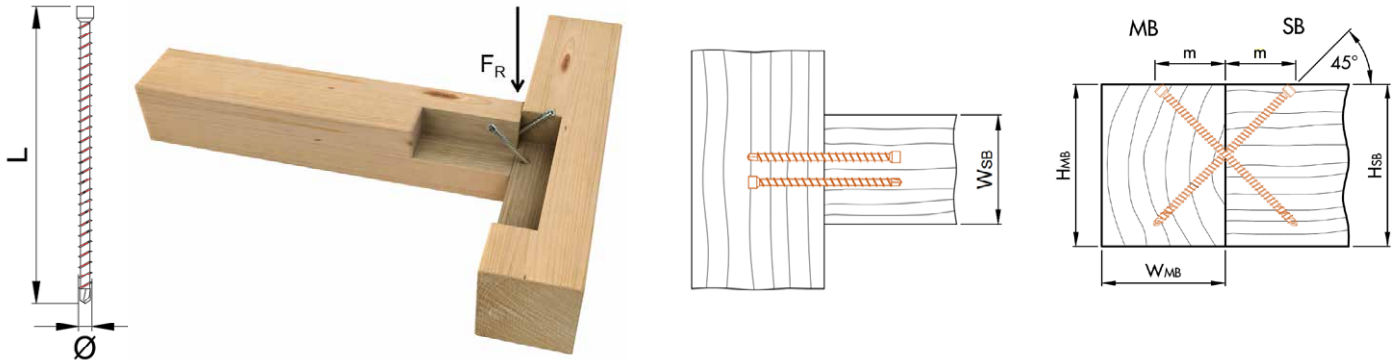

Load-carrying capacity of screws with minimum required lengths.

Ø x L [mm]	min. W <sub>SB</sub> [mm]	min. H <sub>SB</sub> [mm]	min. W <sub>MB</sub> [mm]	min. H <sub>MB</sub> [mm]	F <sub>R,d</sub> [kN]		Pair [n]
					k <sub>mod</sub> = 0,8	k <sub>mod</sub> = 0,9	
10 x 300	80	240	120	240	15,06	16,94	1
	140				28,10	31,61	2
	180				40,47	45,53	3
10 x 330	80	260	140	260	16,56	18,63	1
	140				30,91	34,77	2
	180				44,52	50,08	3
10 x 360	80	280	140	280	18,07	20,33	1
	140				33,72	37,93	2
	180				48,57	54,64	3
10 x 400	80	300	160	300	20,08	22,59	1
	140				37,46	42,15	2
	180				53,96	60,71	3
10 x 450	80	340	180	340	22,59	22,89	1
	140				42,15	42,72	2
	180				60,71	61,53	3
10 x 500	80	380	200	380	22,89	22,89	1
	140				42,72	42,72	2
	180				61,53	61,53	3
10 x 550	80	400	220	400	22,89	22,89	1
	140				42,72	42,72	2
	180				61,53	61,53	3
10 x 600	80	440	240	440	22,89	22,89	1
	140				42,72	42,72	2
	180				61,53	61,53	3

Calculated according to EN 1995-1-1 and ETA-11/0024, with non-predrilled holes and wood density  $\rho_k = 380 \text{ kg/m}^3$ . Design values  $F_{R,d}$  calculated considering  $k_{mod} = 0,8$ ,  $k_{mod} = 0,9$ ,  $\gamma_M = 1,3$  (connections),  $\gamma_{M2} = 1,25$  (tensile fracture), and  $\gamma_{M1} = 1,0$  (instability failure). L is the minimum screw length for achieving the respective load-carrying capacity. Calculation of  $F_{V,Rd} = 2 \cdot n_{pair} \cdot 0,9 \cdot \sin 45^\circ \cdot \min. [F_{0x,cl,Rd}; F_{tens,d}; F_{ki,Rd}]$ .

Please note: These are planning aids. Projects must be calculated only by authorized persons.

# KONSTRUX ST CYLINDER HEAD / COUNTERSUNK HEAD – TIMBER-TIMBER, CROSS SCREWS

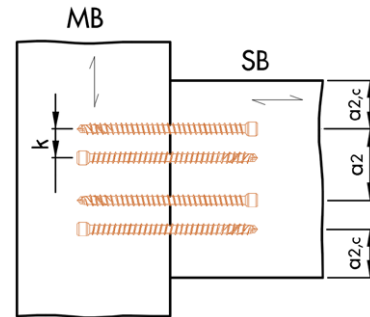
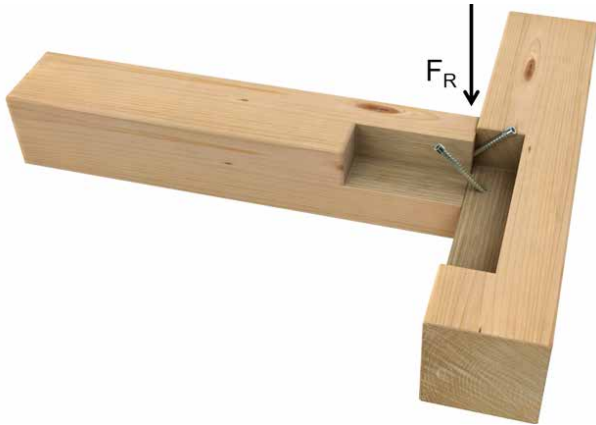

Application with minimum required distances.

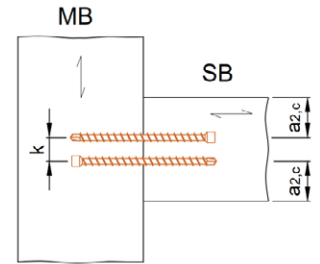
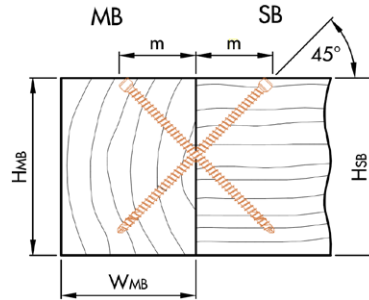
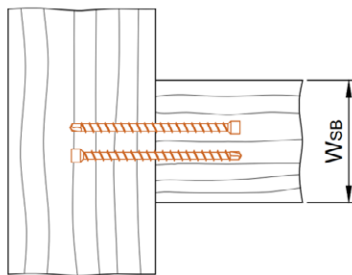
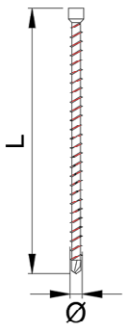

$\varnothing \times L$ [mm]	$W_{SB}$ [mm]	$H_{SB}$ [mm]	$W_{MB}$ [mm]	$H_{MB}$ [mm]	$m$ [mm]	$a_{2,c, \min}$ [mm]	$a_{2, \min}$ [mm]	$k_{\min}$ [mm]	Pair [n]
6,5 x 195	60	160	80	160	69	20	33	10	1
	100								2
	120								3
8,0 x 245	80	200	100	200	87	24	40	12	1
	100								2
	140								3
8,0 x 295	80	220	120	220	104	24	40	12	1
	100								2
	140								3
8,0 x 330	80	260	140	260	117	24	40	12	1
	100								2
	140								3
8,0 x 375	80	280	160	280	133	24	40	12	1
	100								2
	140								3
8,0 x 400	80	300	160	300	141	24	40	12	1
	100								2
	140								3
8,0 x 430	80	320	180	320	152	24	40	12	1
	100								2
	140								3
8,0 x 480	80	360	180	360	170	24	40	12	1
	100								2
	140								3

Calculated according to EN 1995-1-1, with non-predrilled holes. The minimum dimensions for screw applications are taken from ETA to achieve the respective load-carrying capacity.  
Please note: These are planning aids. Projects must be calculated only by authorized persons.

## KONSTRUX ST CYLINDER HEAD / COUNTERSUNK HEAD – TIMBER-TIMBER, CROSS SCREWS (CONT.)

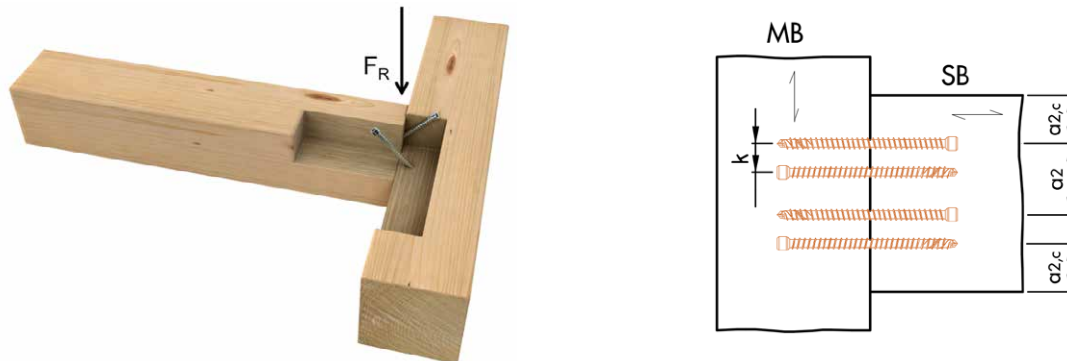

### Application with minimum required distances

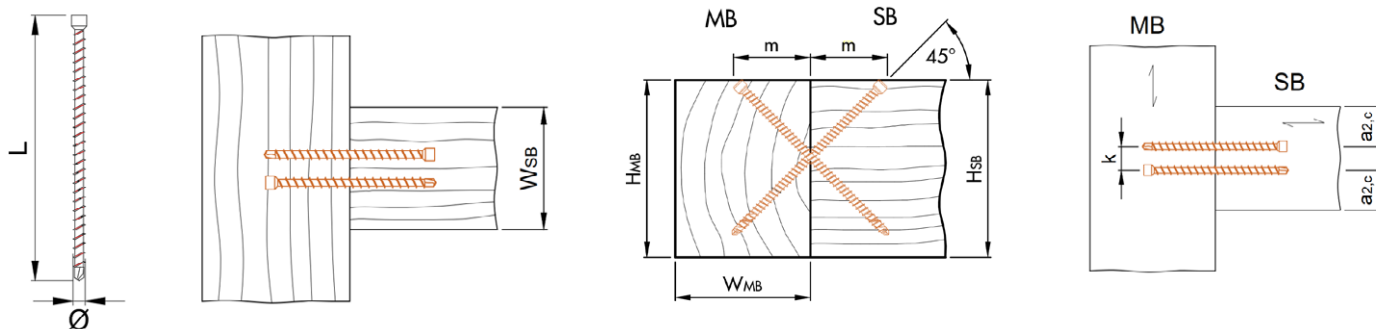

$\varnothing \times L$ [mm]	$W_{SB}$ [mm]	$H_{SB}$ [mm]	$W_{MB}$ [mm]	$H_{MB}$ [mm]	$m$ [mm]	$a_{2,c, \min}$ [mm]	$a_{2, \min}$ [mm]	$k_{\min}$ [mm]	Pair [n]
10 x 300	80	240	120	240	106	30	50	15	1
	140								2
	180								3
10 x 330	80	260	140	260	117	30	50	15	1
	140								2
	180								3
10 x 360	80	280	140	280	127	30	50	15	1
	140								2
	180								3
10 x 400	80	300	160	300	141	30	50	15	1
	140								2
	180								3
10 x 450	80	340	180	340	159	30	50	15	1
	140								2
	180								3
10 x 500	80	380	200	380	177	30	50	15	1
	140								2
	180								3
10 x 550	80	400	220	400	194	30	50	15	1
	140								2
	180								3
10 x 600	80	440	240	440	212	30	50	15	1
	140								2
	180								3

Calculated according to EN 1995-1-1, with non-predrilled holes. Minimum spacing and distances as per ETA-11/0024. Please note: these are planning aids.  
Please note: These are planning aids. Projects must be calculated only by authorized persons.

## KONSTRUX AG EXTERNAL TX HEAD – TIMBER-TIMBER

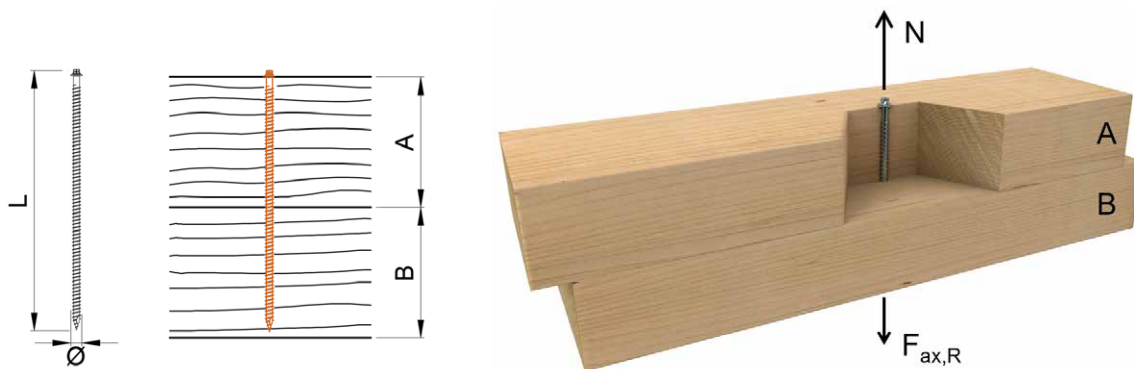

Axial load-carrying capacities of screws with minimum required lengths.

A [mm]	Ø 13 mm		
	L [mm]	$F_{ax,Rk}$ [kN]	$F_{ax,Rd}$ [kN]
150	300	22,49	13,84
170	340	25,49	15,69
190	380	28,49	17,53
210	420	31,49	19,38
230	460	34,49	21,22
250	500	37,49	23,07
270	540	40,49	24,91
290	580	43,48	26,76
310	620	46,48	28,61
330	660	49,48	30,45
350	700	52,48	32,30
375	750	56,23	34,60
400	800	59,98	36,91
450	900	67,48	41,52
500	1000	74,97	46,14
600	1200	75,00	55,37
700	1400	75,00	60,00

Calculated according to EN 1995-1-1, with non-predrilled holes and wood density  $\rho_k = 380 \text{ kg/m}^3$ . Design values  $F_{Rd}$  calculated considering  $k_{mod} = 0,8$  and  $\gamma_M = 1,3$  and  $\gamma_{M2} = 1,25$ . For the longer screws, design values may differ from the corresponding characteristic failure mode (withdrawal or steel tension fracture). Component B thickness is such that:  $B \geq L - A$ . L is the minimum screw length for achieving the respective load-carrying capacity.

**Please note:** These are planning aids. Projects must be calculated only by authorized persons.

## KONSTRUX AG EXTERNAL TX HEAD – TIMBER-TIMBER

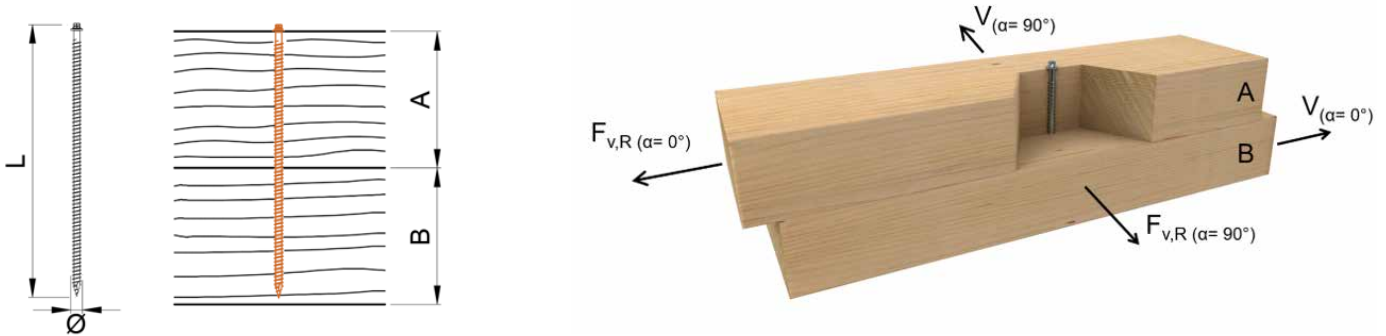

Lateral load-carrying capacities of screws with minimum required lengths.

		Ø 13 mm			
		$\alpha_A = 0^\circ$ $\alpha_B = 0^\circ$		$\alpha_A = 90^\circ$ $\alpha_B = 90^\circ$	
A [mm]	L [mm]	$F_{v,Rk}$ [kN]	$F_{v,Rd}$ [kN]	$F_{v,Rk}$ [kN]	$F_{v,Rd}$ [kN]
150	300	16,20	9,97	14,13	8,70
170	340	16,95	10,43	14,88	9,16
190	380	17,70	10,89	15,63	9,62
210	420	18,45	11,35	16,38	10,08
230	460	19,20	11,81	17,02	10,47
250	500	19,25	12,28	17,02	10,47
270	540	20,70	12,74	17,02	10,47
290	580	21,15	13,02	17,02	10,47
310	620	21,15	13,02	17,02	10,47
330	660	21,15	13,02	17,02	10,47
350	700	21,15	13,02	17,02	10,47
375	750	21,15	13,02	17,02	10,47
400	800	21,15	13,02	17,02	10,47
450	900	21,15	13,02	17,02	10,47
500	1000	21,15	13,02	17,02	10,47
600	1200	21,15	13,02	17,02	10,47
700	1400	21,15	13,02	17,02	10,47

Calculated according to EN 1995-1-1, with non-predrilled holes and wood density  $\rho_k = 380 \text{ kg/m}^3$ . Design values  $F_{v,Rd}$  calculated considering  $k_{mod} = 0,8$  and  $\gamma_M = 1,3$ . Component B thickness is such that:  $B \geq L - A$ . L is the minimum screw length for achieving the respective load-carrying capacity.

**Please note:** These are planning aids. Projects must be calculated only by authorized persons.



## KONSTRUX AG EXTERNAL TX HEAD – TIMBER-TIMBER

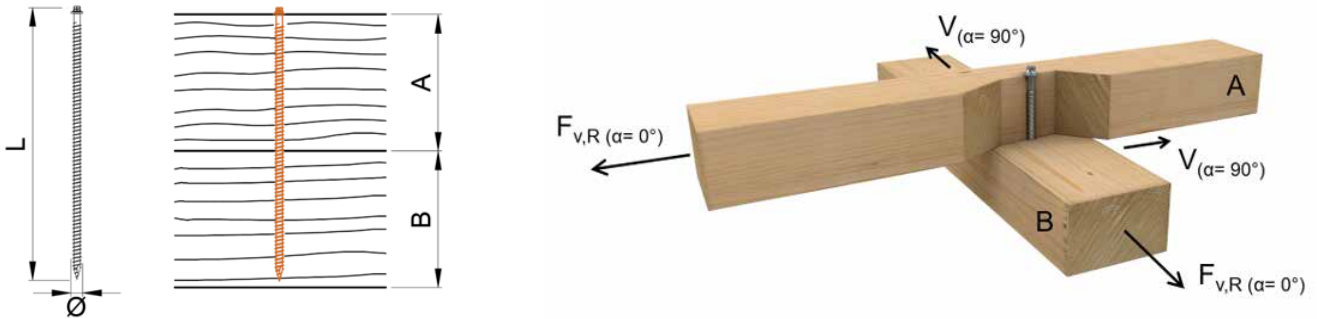

Lateral load-carrying capacities of screws with minimum required lengths.

		Ø 13 mm			
		$\alpha_A = 0^\circ$ $\alpha_B = 90^\circ$		$\alpha_A = 90^\circ$ $\alpha_B = 0^\circ$	
A [mm]	L [mm]	$F_{v,Rk}$ [kN]	$F_{v,Rd}$ [kN]	$F_{v,Rk}$ [kN]	$F_{v,Rd}$ [kN]
150	300	15,00	9,23	15,00	9,23
170	340	15,75	9,69	15,75	9,69
190	380	16,50	10,15	16,50	10,15
210	420	17,25	10,61	17,25	10,61
230	460	18,00	11,08	18,00	11,08
250	500	18,75	11,54	18,75	11,54
270	540	18,75	11,54	18,75	11,54
290	580	18,75	11,54	18,75	11,54
310	620	18,75	11,54	18,75	11,54
330	660	18,75	11,54	18,75	11,54
350	700	18,75	11,54	18,75	11,54
375	750	18,75	11,54	18,75	11,54
400	800	18,75	11,54	18,75	11,54
450	900	18,75	11,54	18,75	11,54
500	1000	18,75	11,54	18,75	11,54
600	1200	18,75	11,54	18,75	11,54
700	1400	18,75	11,54	18,75	11,54

Calculated according to EN 1995-1-1, with non-pre-drilled holes and wood density  $\rho_k = 380 \text{ kg/m}^3$ . Design values  $F_{Rd}$  calculated considering  $k_{mod} = 0,8$  and  $\gamma_M = 1,3$ . Component B thickness is such that:  $B \geq L - A$ . L is the minimum screw length for achieving the respective load-carrying capacity.

**Please note:** These are planning aids. Projects must be calculated only by authorized persons.

## KONSTRUX AG EXTERNAL TX HEAD – TIMBER-TIMBER

Load-carrying capacity of shear-tension screws with minimum required lengths.

Ø 13 mm

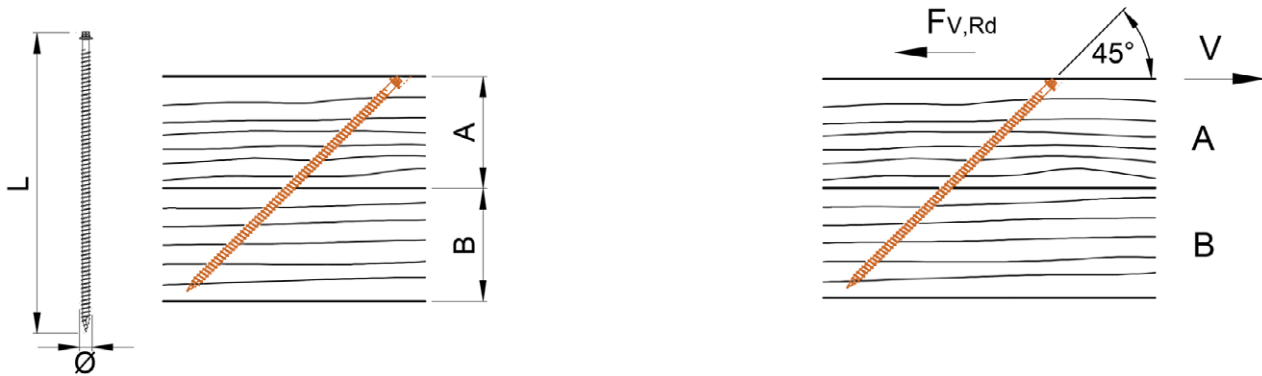

A [mm]	L [mm]	$F_{v,Rk}$ [kN]	$F_{v,Rd}$ [kN]
105	300	15,75	9,69
120	340	17,99	11,07
135	380	20,05	12,34
150	420	22,05	13,57
160	460	23,99	14,77
180	500	26,02	16,01
190	540	28,49	17,53
205	580	30,74	18,92
220	620	32,76	20,16
235	660	34,75	21,38
250	700	36,73	22,60
265	750	39,74	24,46
285	800	42,09	25,90
320	900	47,45	29,20
355	1000	52,80	32,49
425	1200	53,03	39,08
500	1400	53,03	42,43

Calculated according to EN 1995-1-1, with non-predrilled holes and wood density  $\rho_k = 380 \text{ kg/m}^3$ . Design values  $F_{Rd}$  calculated considering  $k_{mod} = 0,8$ ,  $\gamma_M = 1,3$ , and  $\gamma_{M2} = 1,25$ . For the longer screws, design values may differ from the corresponding characteristic failure mode (withdrawal or steel tension fracture). Component B thickness is such that:  $B \geq [L \cdot \sin(\alpha) - A]$ . Depending on installation and surface conditions, design values may be increased by 25 % due to friction (see example on p. 22). L is the minimum screw length for achieving the respective load-carrying capacity. Load capacity values are not dependent on the grain orientations of components A and B.

**Please note:** These are planning aids. Projects must be calculated only by authorized persons.

## KONSTRUX AG EXTERNAL TX HEAD – STEEL-TIMBER, THICK PLATE

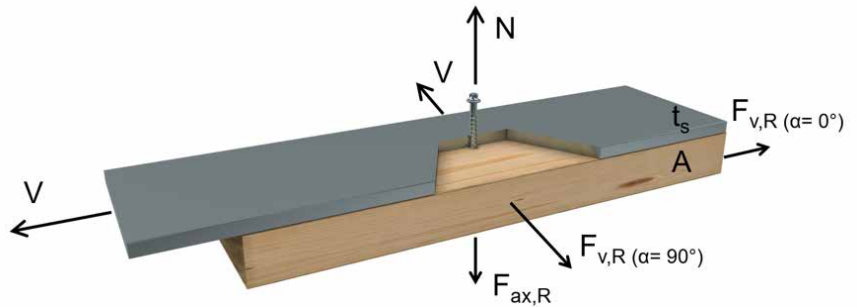
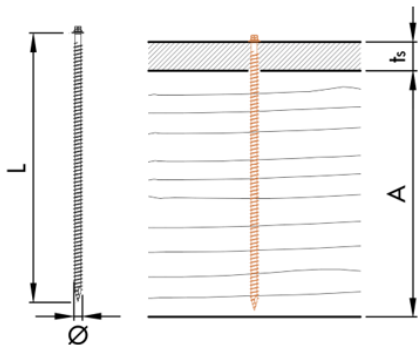

Lateral load-carrying capacities of screws with minimum required lengths.

		Ø 13 mm t <sub>s</sub> = 20 mm					
		–		α <sub>A</sub> = 0°		α <sub>A</sub> = 90°	
A [mm]	L [mm]	F <sub>ax,Rk</sub> [kN]	F <sub>ax,Rd</sub> [kN]	F <sub>v,Rk</sub> [kN]	F <sub>v,Rd</sub> [kN]	F <sub>v,Rk</sub> [kN]	F <sub>v,Rd</sub> [kN]
300	300	41,99	25,84	25,45	15,66	22,53	13,86
340	340	47,98	29,53	26,95	16,59	24,03	14,79
380	380	53,98	33,22	28,45	17,51	24,07	14,81
420	420	59,98	36,91	29,91	18,41	24,07	14,81
460	460	65,98	40,60	29,91	18,41	24,07	14,81
500	500	71,97	44,29	29,91	18,41	24,07	14,81
540	540	75,00	47,98	29,91	18,41	24,07	14,81
580	580	75,00	51,67	29,91	18,41	24,07	14,81
620	620	75,00	55,37	29,91	18,41	24,07	14,81
660	660	75,00	59,06	29,91	18,41	24,07	14,81
700	700	75,00	60,00	29,91	18,41	24,07	14,81
750	750	75,00	60,00	29,91	18,41	24,07	14,81
800	800	75,00	60,00	29,91	18,41	24,07	14,81
900	900	75,00	60,00	29,91	18,41	24,07	14,81
1000	1000	75,00	60,00	29,91	18,41	24,07	14,81
1200	1200	75,00	60,00	29,91	18,41	24,07	14,81
1400	1400	75,00	60,00	29,91	18,41	24,07	14,81

Calculated according to EN 1995-1-1, with non-predrilled holes and wood density  $\rho_k = 380 \text{ kg/m}^3$ . Design values  $F_{Rd}$  calculated considering  $k_{mod} = 0,8$  and  $\gamma_M = 1,3$  and  $\gamma_{M2} = 1,25$ . For the longer screws, design values may differ from the corresponding characteristic failure mode (withdrawal or steel tension fracture). L is the minimum screw length for achieving the respective load-carrying capacity.

**Please note:** these are planning aids. Projects must be calculated only by authorized persons.

# KONSTRUX STAINLESS STEEL A4

The high-performance fully threaded screw for new construction and reinforcement



KonstruX fully threaded screws **maximize the load-bearing capacity of a connection** due to the **high thread extraction resistance** in both components. When using partially threaded screws, the significantly lower head pull-through resistance in the attachment part limits the load-bearing capacity of the connection. KonstruX fully threaded screw provide a **cost-saving alternative** to traditional connectors or timber connectors such as joist shoes and joist girders.

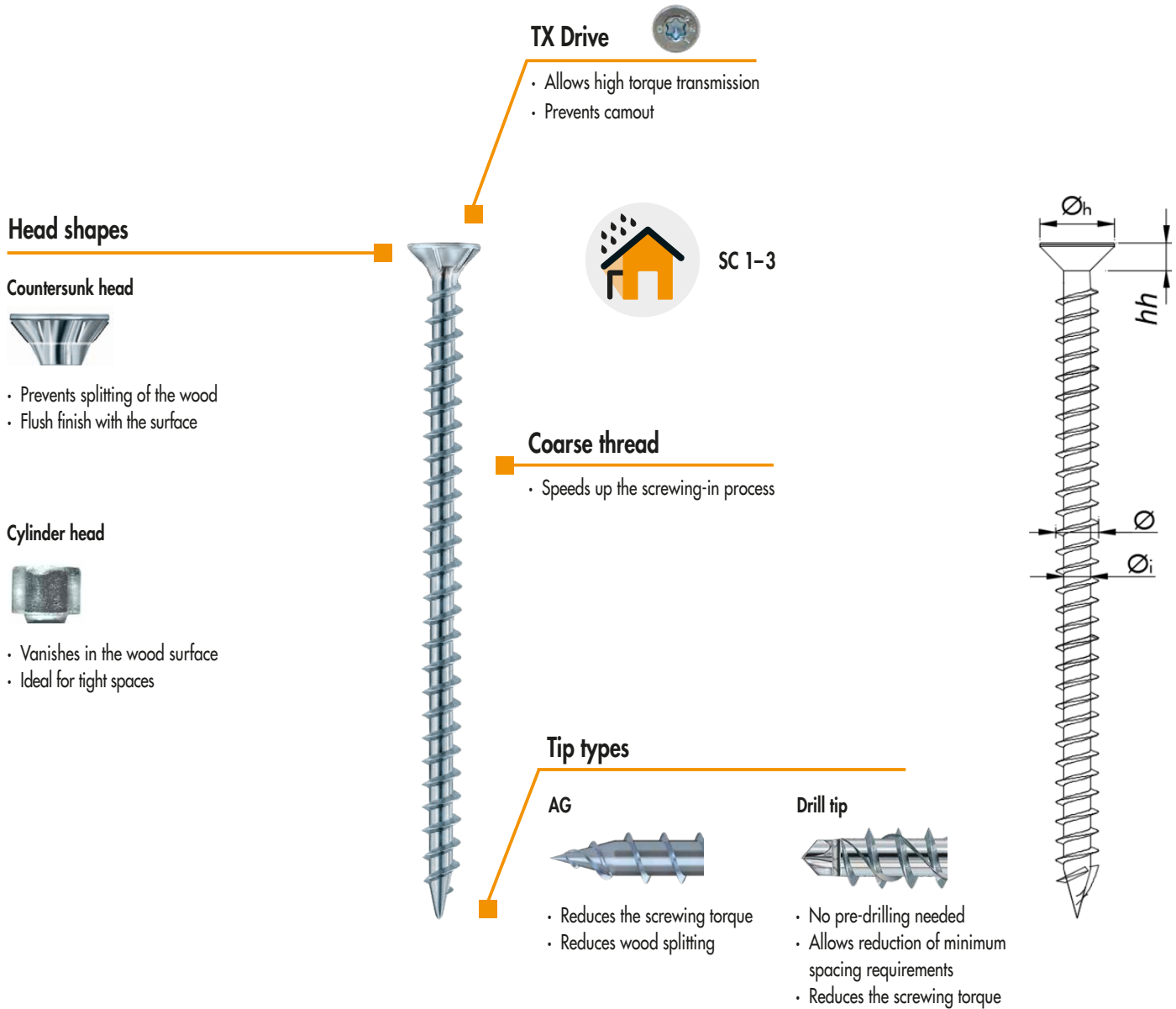

## KonstruX Stainless Steel A4

Geometric properties				Mechanical properties				
Nominal $\varnothing$ [mm]	Inner $\varnothing_i$ [mm]	Head <sup>a)</sup> $\varnothing_h$ [mm]	Head depth <sup>a)</sup> hh [mm]	Tip type	$f_{tens,k}$ [kN]	$f_{ax,k}$ [MPa]	$M_{y,k}$ [Nm]	$F_{ki,Rk}$ <sup>b)</sup> [kN]
6,5	4,5	8,0	5,5	Drill	10,0	11,4	10,0	5,9
8	5,2	14,5/10	7,4/6,5	AG/Drill	14,0	11,1	16,0	7,9
10	5,9	17,8	8,7	AG	20,0	10,8	26,0	10,7

a) Countersunk head/Cylinder head.  $\varnothing 6,5$  mm only available in cylinder head version,  $\varnothing 10$  mm only available in countersunk head version.

b) Characteristic buckling capacity  $F_{ki,Rk}$  calculated for  $\rho_k = 380 \text{ kg/m}^3$ .

# MINIMUM DISTANCES FOR AXIAL LOADS

	KonstruX ST A4 (Drill tip)	KonstruX A4 (AG tip)
--	----------------------------	----------------------

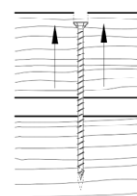
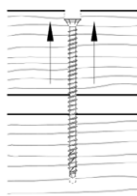

Ø [mm]	With and without predrilled holes			Predrilled holes			Non-predrilled holes		
	Rules	6,5	8	Rules	8	10	Rules	8	10
$a_1$	5 · d	33	40	5 · d	40	50	5 · d	40	50
$a_2$	5 · d	33	40	5 · d	40	50	5 · d	40	50
$a_{2,red}$	2,5 · d	16	20	2,5 · d	20	25	2,5 · d	20	25
$a_{1,c}$	5 · d	33	40	5 · d	40	50	10 · d	80	100
$a_{2,c}$	3 · d	20	24	3 · d	24	30	4 · d	32	40
$a_x$	1,5 · d	10	12	1,5 · d	12	15	1,5 · d	12	15

## Crossed screws under tension

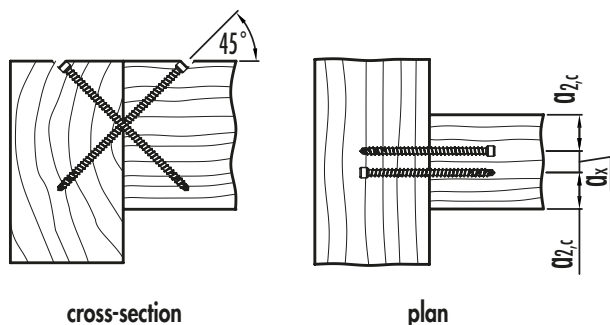

## Screws inserted perpendicular to the grain

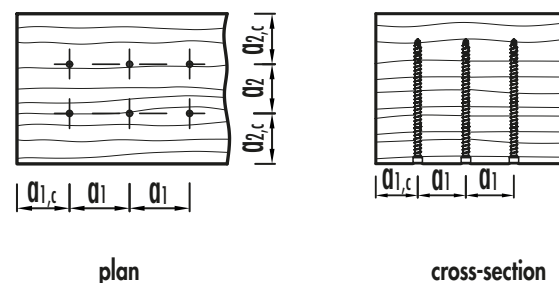

## Tensioned screws inserted with an angle $\alpha$ with respect to the wood grain direction

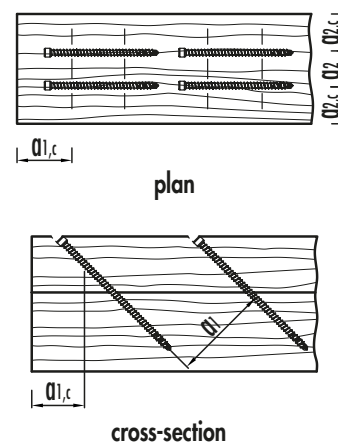
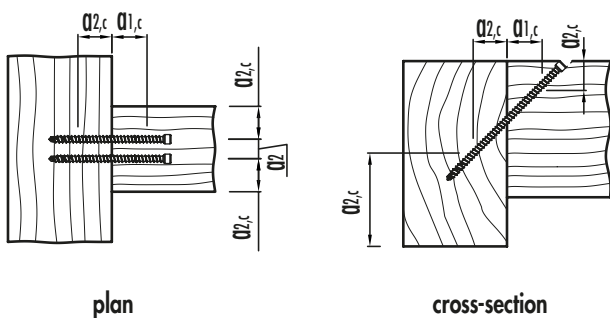

Notes: The minimum distances for axially-loaded screws are in accordance with ETA-11/0024 considering a softwood density of  $\rho_k \leq 420 \text{ kg/m}^3$ , where  $d$  = nominal screw diameter, minimum wood thickness,  $t = 10 \cdot d$  and minimum width,  $w = \max [ 8 \cdot d; 60 \text{ mm} ]$ . For steel-to-timber joints, the axial spacings  $a_1$  and  $a_2$  can be reduced by a factor of 0,7.

# MINIMUM DISTANCES FOR SHEAR LOADS

## KonstruX A4 (AG and Drill tip)

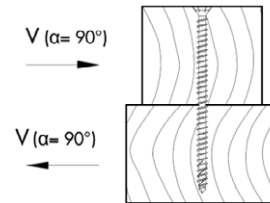
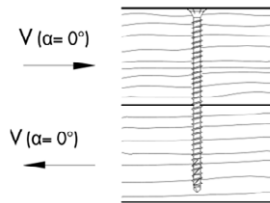

Ø [mm]	Predrilled holes						Predrilled holes					
	Rules	6,5	8	10	11,3	13	Rules	6,5	8	10	11,3	13
a <sub>1</sub>	5 · d	33	40	50	57	65	4 · d	26	32	40	45	52
a <sub>2</sub>	3 · d	20	24	30	34	39	4 · d	26	32	40	45	52
a <sub>3,c</sub>	7 · d	46	56	70	79	91	7 · d	46	56	70	79	91
a <sub>3,t</sub>	12 · d	78	96	120	136	156	7 · d	46	56	70	79	91
a <sub>4,c</sub>	3 · d	20	24	30	34	39	3 · d	20	24	30	34	39
a <sub>4,t</sub>	3 · d	20	24	30	34	39	7 · d	46	56	70	79	91

Ø [mm]	Non-predrilled holes						Non-predrilled holes					
	Rules	6,5	8	10	11,3	13	Rules	6,5	8	10	11,3	13
a <sub>1</sub>	12 · d	33	78	96	120	136	5 · d	33	40	50	57	65
a <sub>2</sub>	5 · d	20	33	40	50	57	5 · d	33	40	50	57	65
a <sub>3,c</sub>	10 · d	46	65	80	100	113	10 · d	65	80	100	113	130
a <sub>3,t</sub>	15 · d	78	98	120	150	170	10 · d	65	80	100	113	130
a <sub>4,c</sub>	5 · d	20	33	40	50	57	5 · d	33	40	50	57	65
a <sub>4,t</sub>	5 · d	20	33	40	50	57	10 · d	65	80	100	113	130

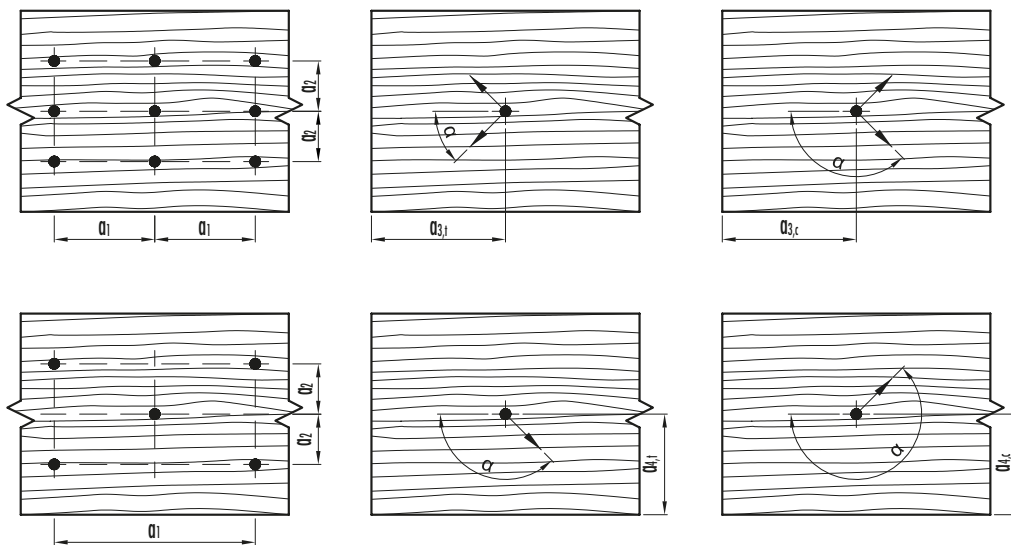

Notes: The minimum distances for axially-loaded screws are in accordance with ETA-11/0024 considering a softwood density of  $\rho_k \leq 420 \text{ kg/m}^3$ , where  $d$  = nominal screw diameter, minimum wood thickness,  $t = 10 \cdot d$  and minimum width,  $w = \max [ 8 \cdot d; 60 \text{ mm} ]$ . For steel-to-timber joints, the axial spacings  $a_1$  and  $a_2$  can be reduced by a factor of 0,7. In wood members of Douglas fir, the minimum distances must be increased by 1,5. The edge distances and spacings of each timber member must be checked independently according to load and grain direction.

## KONSTRUX STAINLESS STEEL A4 COUNTERSUNK HEAD – TIMBER-TIMBER



Axial load-carrying capacity of screws with minimum required lengths.

A [mm]	Ø 8 mm			Ø 10 mm		
	$F_{v,Rk}$ [kN]	$F_{v,Rd}$ [kN]	L [mm]	$F_{v,Rk}$ [kN]	$F_{v,Rd}$ [kN]	L [mm]
60	4,99	3,07	125			
80	6,89	4,24	155	8,22	5,06	160
100	8,78	5,40	195	10,53	6,48	200
120				11,53	7,10	220
120				12,84	7,90	240
140				13,84	8,52	260
140				15,14	9,32	280
160				16,15	9,94	300
180				19,61	12,07	350
200				20,00	13,58	400
240				20,00	14,91	450
280				20,00	15,62	500

Calculated according to EN 1995-1-1, with non-predrilled holes and wood density  $\rho_k = 380 \text{ kg/m}^3$ . Design values  $F_{Rd}$  calculated considering  $k_{mod} = 0,8$  and  $\gamma_M = 1,3$  and  $\gamma_{M2} = 1,25$ . For the longer screws, design values may differ from the corresponding characteristic failure mode (withdrawal or steel tension fracture). Component B thickness is such that:  $B \geq L - A$ . L is the minimum screw length for achieving the respective load-carrying capacity.

Please note: these are planning aids. Projects must be calculated only by authorized persons.

## KONSTRUX STAINLESS STEEL A4 COUNTERSUNK HEAD – TIMBER-TIMBER



Lateral load-carrying capacity of screws with minimum required lengths.

A [mm]	Ø 8 mm			Ø 10 mm			Ø 8 mm			Ø 10 mm		
	$\alpha_A = 0^\circ$ $\alpha_B = 0^\circ$						$\alpha_A = 90^\circ$ $\alpha_B = 90^\circ$					
	$F_{v,Rk}$ [kN]	$F_{v,Rd}$ [kN]	L [mm]	$F_{v,Rk}$ [kN]	$F_{v,Rd}$ [kN]	L [mm]	$F_{v,Rk}$ [kN]	$F_{v,Rd}$ [kN]	L [mm]	$F_{v,Rk}$ [kN]	$F_{v,Rd}$ [kN]	L [mm]
60	4,36	2,68	125				3,82	2,35	125			
80	4,84	2,98	155	6,45	3,97	160	4,29	2,64	155	5,64	3,47	160
100	5,31	3,27	195	7,02	4,32	200	4,77	2,94	195	6,22	3,83	200
120				7,28	4,48	220				6,47	3,98	220
120				7,60	4,68	240				6,80	4,18	240
140				7,85	4,83	260				7,05	4,34	260
140				8,18	5,03	280				7,17	4,41	280
160				8,43	5,19	300				7,17	4,41	300
180				8,78	5,40	350				7,17	4,41	350
200				8,78	5,40	400				7,17	4,41	400
240				8,78	5,40	450				7,17	4,41	450
280				8,78	5,40	500				7,17	4,41	500

Calculated according to EN 1995-1-1, with non-predrilled holes and wood density  $\rho_k = 380 \text{ kg/m}^3$ . Design values  $F_{v,Rd}$  calculated considering  $k_{mod} = 0,8$  and  $\gamma_M = 1,3$ . Component B thickness is such that:  $B \geq L - A$ . L is the minimum screw length for achieving the respective load-carrying capacity.

**Please note:** These are planning aids. Projects must be calculated only by authorized persons.



# KONSTRUX STAINLESS STEEL A4 COUNTERSUNK HEAD – TIMBER-TIMBER

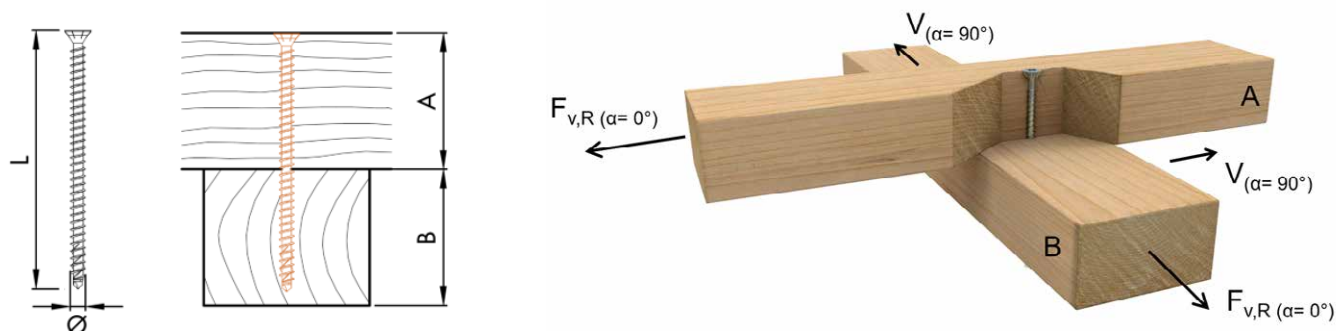

Lateral load-carrying capacity of screws with minimum required lengths.

A [mm]	Ø 8 mm			Ø 10 mm			Ø 8 mm			Ø 10 mm		
	$\alpha_A = 0^\circ$ $\alpha_B = 90^\circ$						$\alpha_A = 90^\circ$ $\alpha_B = 0^\circ$					
	$F_{v,Rk}$ [kN]	$F_{v,Rd}$ [kN]	L [mm]	$F_{v,Rk}$ [kN]	$F_{v,Rd}$ [kN]	L [mm]	$F_{v,Rk}$ [kN]	$F_{v,Rd}$ [kN]	L [mm]	$F_{v,Rk}$ [kN]	$F_{v,Rd}$ [kN]	L [mm]
60	4,05	2,49	125				4,05	2,49	125			
80	4,52	2,78	155	5,98	3,68	160	4,52	2,78	155	5,98	3,68	160
100	5,00	3,08	195	6,56	4,04	200	5,00	3,08	195	6,56	4,04	200
120				6,81	4,19	220				6,81	4,19	220
120				7,14	4,39	240				7,14	4,39	240
140				7,39	4,55	260				7,39	4,55	260
140				7,71	4,74	280				7,71	4,74	280
160				7,86	4,84	300				7,86	4,84	300
180				7,86	4,84	350				7,86	4,84	350
200				7,86	4,84	400				7,86	4,84	400
240				7,86	4,84	450				7,86	4,84	450
280				7,86	4,84	500				7,86	4,84	500

Calculated according to EN 1995-1-1, with non-predrilled holes and wood density  $\rho_k = 380 \text{ kg/m}^3$ . Design values  $F_{v,Rd}$  calculated considering  $k_{mod} = 0,8$  and  $\gamma_m = 1,3$ . Component B thickness is such that:  $B \geq L - A$ . L is the minimum screw length for achieving the respective load-carrying capacity.

**Please note:** These are planning aids. Projects must be calculated only by authorized persons.

## KONSTRUX STAINLESS STEEL A4 COUNTERSUNK HEAD – TIMBER-TIMBER, 45° INCLINED SCREWS

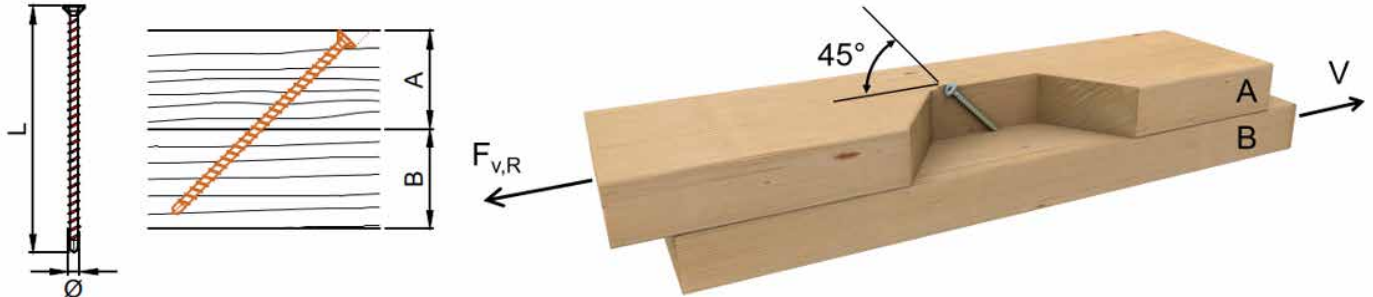

Load-carrying capacity of shear-tension screws with minimum required lengths.

A [mm]	Ø 8 mm			Ø 10 mm		
	$F_{v,Rk}$ [kN]	$F_{v,Rd}$ [kN]	L [mm]	$F_{v,Rk}$ [kN]	$F_{v,Rd}$ [kN]	L [mm]
60	2,69	1,66	125			
60	4,70	2,89	155	6,13	3,77	160
80	5,49	3,38	195	7,09	4,36	200
80				8,52	5,24	220
100				8,04	4,95	240
100				9,67	5,95	260
120				9,00	5,54	280
120				10,63	6,54	300
140				12,40	7,63	350
160				14,14	8,72	400
180				14,14	11,31	500

Calculated according to EN 1995-1-1, with non-predrilled holes and wood density  $\rho_k = 380 \text{ kg/m}^3$ . Design values  $F_{Rd}$  calculated considering  $k_{mod} = 0,8$ ,  $\gamma_M = 1,3$ , and  $\gamma_{M2} = 1,25$ . For the longer screws, design values may differ from the corresponding characteristic failure mode (withdrawal or steel tension fracture). Component B thickness is such that:  $B \geq [L \cdot \sin(\alpha) - A]$ . Load capacity values are not dependent on the grain orientations of components A and B. Depending on installation and surface conditions, design values may be increased by 25 % due to friction (see example on p. 22). L is the minimum screw length for achieving the respective load-carrying capacity.

**Please note:** These are planning aids. Projects must be calculated only by authorized persons.

## KONSTRUX STAINLESS STEEL A4 COUNTERSUNK HEAD – STEEL-TIMBER



Axial load-carrying capacity of screws with minimum required lengths.

A [mm]	Ø 8 mm $t_s = 15$ mm			Ø 10 mm $t_s = 15$ mm		
	$F_{ax,Rk}$ [kN]	$F_{ax,Rd}$ [kN]	L [mm]	$F_{ax,Rk}$ [kN]	$F_{ax,Rd}$ [kN]	L [mm]
125	10,43	6,42	125			
160	13,28	8,17	155	16,72	10,29	160
200	14,00	10,51	195	20,00	13,13	200
220				20,00	14,55	220
240				20,00	16,00	240
260				20,00	16,00	260
280				20,00	16,00	280
300				20,00	16,00	300
350				20,00	16,00	350
400				20,00	16,00	400
450				20,00	16,00	450
500				20,00	16,00	500

Calculated according to EN 1995-1-1, with non-predrilled holes and wood density  $\rho_k = 380$  kg/m<sup>3</sup>. Design values  $F_{Rd}$  calculated considering  $k_{mod} = 0,8$  and  $\gamma_M = 1,3$  and  $\gamma_{M2} = 1,25$ . For the longer screws, design values may differ from the corresponding characteristic failure mode (withdrawal or steel tension fracture). L is the minimum screw length for achieving the respective load-carrying capacity.

**Please note:** These are planning aids. Projects must be calculated only by authorized persons.

## KONSTRUX STAINLESS STEEL A4 COUNTERSUNK HEAD – STEEL-TIMBER, 45° INCLINED SCREWS

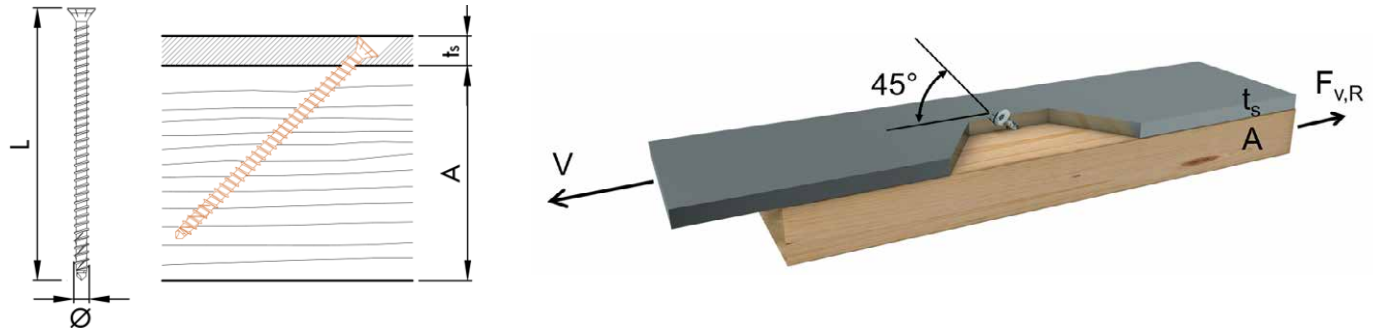

Load-carrying capacity of shear-tension screws with minimum required lengths.

A [mm]	Ø 8 mm $t_s = 15$ mm			Ø 10 mm $t_s = 15$ mm		
	$F_{v,Rk}$ [kN]	$F_{v,Rd}$ [kN]	L [mm]	$F_{v,Rk}$ [kN]	$F_{v,Rd}$ [kN]	L [mm]
100	6,96	4,28	125			
120	8,97	5,52	155	11,32	6,97	160
140	11,65	7,17	195	14,14	8,97	200
160				14,14	9,98	220
180				14,14	11,31	240
200				14,14	11,31	260
200				14,14	11,31	280
220				14,14	11,31	300
240				14,14	11,31	350
280				14,14	11,31	400
320				14,14	11,31	450
360				14,14	11,31	500

Calculated according to EN 1995-1-1, with non-predrilled holes and wood density  $\rho_k = 380 \text{ kg/m}^3$ . Design values  $F_{Rd}$  calculated considering  $k_{mod} = 0,8$  and  $\gamma_M = 1,3$  and  $\gamma_{M2} = 1,25$ . For the longer screws, design values may differ from the corresponding characteristic failure mode (withdrawal or steel tension fracture). L is the minimum screw length for achieving the respective load-carrying capacity.

**Please note:** These are planning aids. Projects must be calculated only by authorized persons.

## KONSTRUX STAINLESS STEEL A4 COUNTERSUNK HEAD – STEEL-TIMBER, THICK PLATE

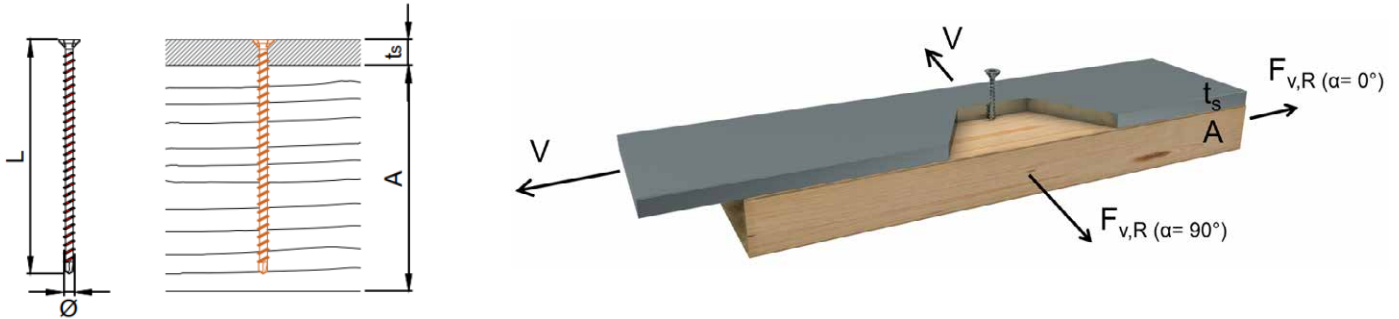

Lateral load-carrying capacity of screws with minimum required lengths.

A [mm]	Ø 8 mm $t_s = 15$ mm			Ø 10 mm $t_s = 15$ mm			Ø 8 mm $t_s = 15$ mm			Ø 10 mm $t_s = 15$ mm		
	$\alpha_A = 0^\circ$						$\alpha_A = 90^\circ$					
	$F_{v,Rk}$ [kN]	$F_{v,Rd}$ [kN]	L [mm]	$F_{v,Rk}$ [kN]	$F_{v,Rd}$ [kN]	L [mm]	$F_{v,Rk}$ [kN]	$F_{v,Rd}$ [kN]	L [mm]	$F_{v,Rk}$ [kN]	$F_{v,Rd}$ [kN]	L [mm]
125	7,01	4,31	125				6,24	3,84	125			
160	7,73	4,76	155	10,39	6,39	160	6,95	4,28	155	9,25	5,69	160
200	7,91	4,87	195	11,21	6,90	200	7,13	4,39	195	10,07	6,20	200
220				11,21	6,90	220				10,07	6,20	220
240				11,21	6,90	240				10,07	6,20	240
260				11,21	6,90	260				10,07	6,20	260
280				11,21	6,90	280				10,07	6,20	280
300				11,21	6,90	300				10,07	6,20	300
350				11,21	6,90	350				10,07	6,20	350
400				11,21	6,90	400				10,07	6,20	400
450				11,21	6,90	450				10,07	6,20	450
500				11,21	6,90	500				10,07	6,20	500

Calculated according to EN 1995-1-1, with non-predrilled holes and wood density  $\rho_k = 380$  kg/m<sup>3</sup>. Design values  $F_{Rd}$  calculated considering  $k_{mod} = 0,8$  and  $\gamma_M = 1,3$ . Component B thickness is such that:  $B \geq L - A$ . L is the minimum screw length for achieving the respective load-carrying capacity.

**Please note:** These are planning aids. Projects must be calculated only by authorized persons.

## KONSTRUX STAINLESS STEEL A4 CYLINDER HEAD – TIMBER-TIMBER



Axial load-carrying capacity of screws with minimum required lengths.

A [mm]	Ø 6,5 mm			Ø 8 mm		
	$F_{ax,Rk}$ [kN]	$F_{ax,Rd}$ [kN]	L [mm]	$F_{ax,Rk}$ [kN]	$F_{ax,Rd}$ [kN]	L [mm]
80	4,75	2,92	140			
80	5,90	3,63	160	6,89	4,24	155
100	7,48	4,60	195	8,78	5,40	195
120				9,48	5,83	220
120				10,76	6,62	245
140				12,33	7,59	270
140				12,66	7,79	295
160				14,00	8,96	330
180				14,00	10,13	375
200				14,00	11,20	400

Calculated according to EN 1995-1-1, with non-predrilled holes and wood density  $\rho_k = 380 \text{ kg/m}^3$ . Design values  $F_{Rd}$  calculated considering  $k_{mod} = 0,8$  and  $\gamma_M = 1,3$  and  $\gamma_{M2} = 1,25$ . For the longer screws, design values may differ from the corresponding characteristic failure mode (withdrawal or steel tension fracture). Component B thickness is such that:  $B \geq L - A$ . L is the minimum screw length for achieving the respective load-carrying capacity.

**Please note:** These are planning aids. Projects must be calculated only by authorized persons.

## KONSTRUX STAINLESS STEEL A4 CYLINDER HEAD – TIMBER-TIMBER

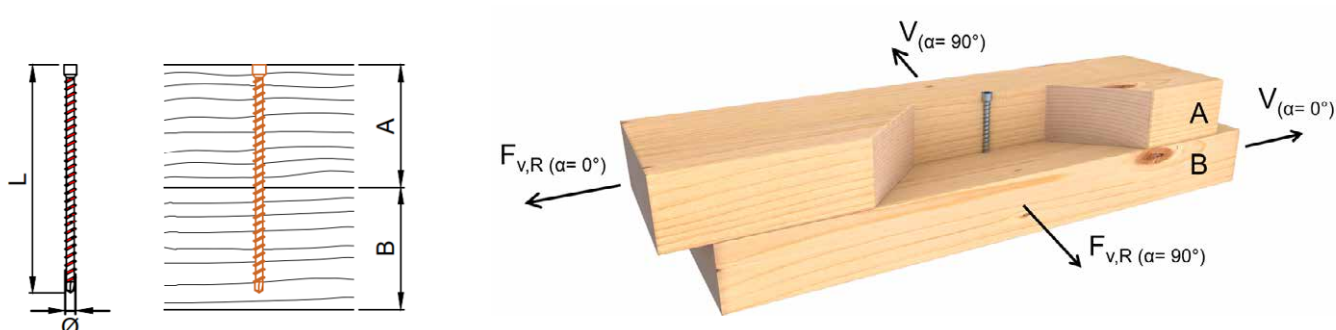

Lateral load-carrying capacity of screws with minimum required lengths.

A [mm]	Ø 6,5 mm			Ø 8 mm			Ø 6,5 mm			Ø 8 mm		
	$\alpha_A = 0^\circ$ $\alpha_B = 0^\circ$						$\alpha_A = 90^\circ$ $\alpha_B = 90^\circ$					
	$F_{v,Rk}$ [kN]	$F_{v,Rd}$ [kN]	L [mm]	$F_{v,Rk}$ [kN]	$F_{v,Rd}$ [kN]	L [mm]	$F_{v,Rk}$ [kN]	$F_{v,Rd}$ [kN]	L [mm]	$F_{v,Rk}$ [kN]	$F_{v,Rd}$ [kN]	L [mm]
80	3,43	2,11	140				3,05	1,88	140			
80	3,71	2,28	160	4,86	2,99	155	3,33	2,05	160	4,31	2,65	155
100	4,11	2,53	195	5,33	3,28	195	3,72	2,29	195	4,79	2,95	195
120				5,49	3,38	220				4,94	3,04	220
120				5,81	3,58	245				5,14	3,16	245
140				6,20	3,82	270				5,14	3,16	270
140				6,23	3,83	295				5,14	3,16	295
160				6,23	3,83	330				5,14	3,16	330
180				6,23	3,83	375				5,14	3,16	375
200				6,23	3,83	400				5,14	3,16	400

Calculated according to EN 1995-1-1, with non-pre-drilled holes and wood density  $\rho_k = 380 \text{ kg/m}^3$ . Design values  $F_{Rd}$  calculated considering  $k_{mod} = 0,8$  and  $\gamma_M = 1,3$ . Component B thickness is such that:  $B \geq L - A$ . L is the minimum screw length for achieving the respective load-carrying capacity.

**Please note:** These are planning aids. Projects must be calculated only by authorized persons.

## KONSTRUX STAINLESS STEEL A4 CYLINDER HEAD – TIMBER-TIMBER

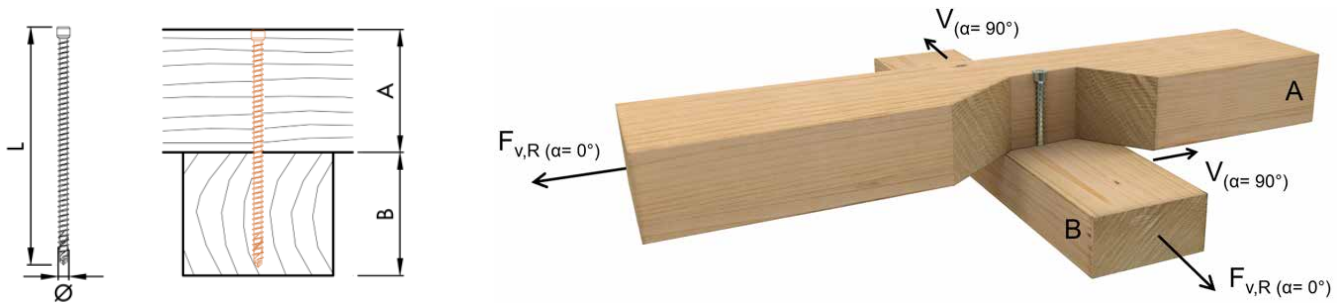

Lateral load-carrying capacity of screws with minimum required lengths.

A [mm]	Ø 6,5 mm			Ø 8 mm			Ø 6,5 mm			Ø 8 mm		
	$\alpha_A = 0^\circ$ $\alpha_B = 90^\circ$						$\alpha_A = 90^\circ$ $\alpha_B = 90^\circ$					
	$F_{v,Rk}$ [kN]	$F_{v,Rd}$ [kN]	L [mm]	$F_{v,Rk}$ [kN]	$F_{v,Rd}$ [kN]	L [mm]	$F_{v,Rk}$ [kN]	$F_{v,Rd}$ [kN]	L [mm]	$F_{v,Rk}$ [kN]	$F_{v,Rd}$ [kN]	L [mm]
80	3,21	1,98	140				3,21	1,98	140			
80	3,50	2,15	160	4,55	2,80	155	3,50	2,15	160	4,55	2,80	155
100	3,89	2,39	195	5,02	3,09	195	3,89	2,39	195	5,02	3,09	195
120				5,17	3,18	220				5,17	3,18	220
120				5,49	3,38	245				5,49	3,38	245
140				5,61	3,45	270				5,61	3,45	270
140				5,61	3,45	295				5,61	3,45	295
160				5,61	3,45	330				5,61	3,45	330
180				5,61	3,45	375				5,61	3,45	375
200				5,61	3,45	400				5,61	3,45	400

Calculated according to EN 1995-1-1, with non-predrilled holes and wood density  $\rho_k = 380 \text{ kg/m}^3$ . Design values  $F_{Rd}$  calculated considering  $k_{mod} = 0,8$  and  $\gamma_M = 1,3$ . Component B thickness is such that:  $B \geq L - A$ . L is the minimum screw length for achieving the respective load-carrying capacity.

**Please note:** These are planning aids. Projects must be calculated only by authorized persons.



## KONSTRUX STAINLESS STEEL A4 CYLINDER HEAD – TIMBER-TIMBER, 45° INCLINED SCREWS

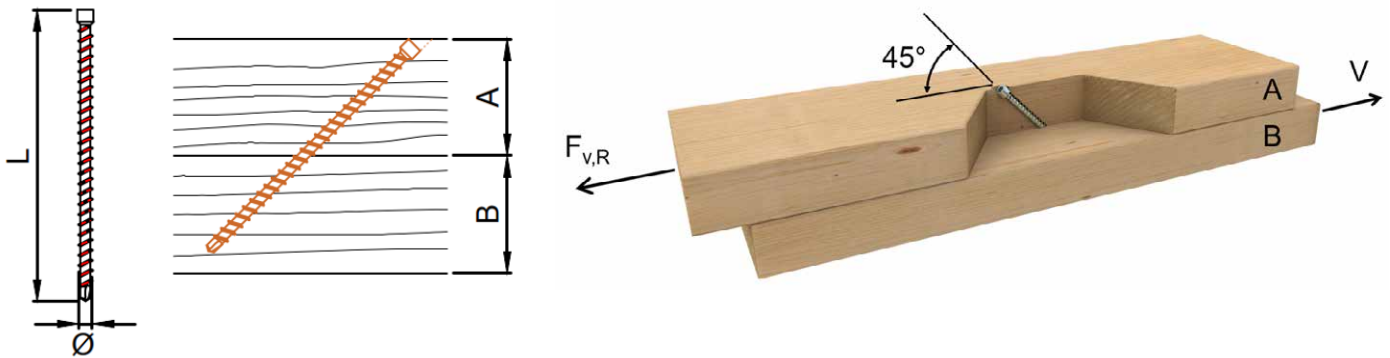

Load-carrying capacity of shear-tension screws with minimum required lengths.

A [mm]	Ø 6,5 mm			Ø 8 mm		
	$F_{v,Rk}$ [kN]	$F_{v,Rd}$ [kN]	L [mm]	$F_{v,Rk}$ [kN]	$F_{v,Rd}$ [kN]	L [mm]
60	3,09	1,90	140			
60	4,21	2,59	160	4,70	2,89	155
80	3,86	2,38	195	5,49	3,38	195
80				7,15	4,40	220
100				6,95	4,28	245
100				8,62	5,30	270
120				8,40	5,17	295
120				9,90	6,09	330
140				9,90	7,30	375
160				9,90	7,17	400

Calculated according to EN 1995-1-1, with non-predrilled holes and wood density  $\rho_k = 380 \text{ kg/m}^3$ . Design values  $F_{Rd}$  calculated considering  $k_{mod} = 0,8$ ,  $\gamma_M = 1,3$ , and  $\gamma_{M2} = 1,25$ . For the longer screws, design values may differ from the corresponding characteristic failure mode (withdrawal or steel tension fracture). Component B thickness is such that:  $B \geq [L \cdot \sin(\alpha) - A]$ . Load capacity values are not dependent on the grain orientations of components A and B. Depending on installation and surface conditions, design values may be increased by 25 % due to friction (see example on p. 22). L is the minimum screw length for achieving the respective load-carrying capacity.

**Please note:** These are planning aids. Projects must be calculated only by authorized persons.

# PANELTWISTEC AG

The high fidelity partially threaded screw for assembly



The Paneltwistec AG wood construction screw is made of hardened carbon blue galvanized steel. It is equipped with a **special tip with folded-down thread**, which **reduces the screw-in torque** and **increases the grip**. Paneltwistec wood construction screws are available in both countersunk head and Washer head versions.

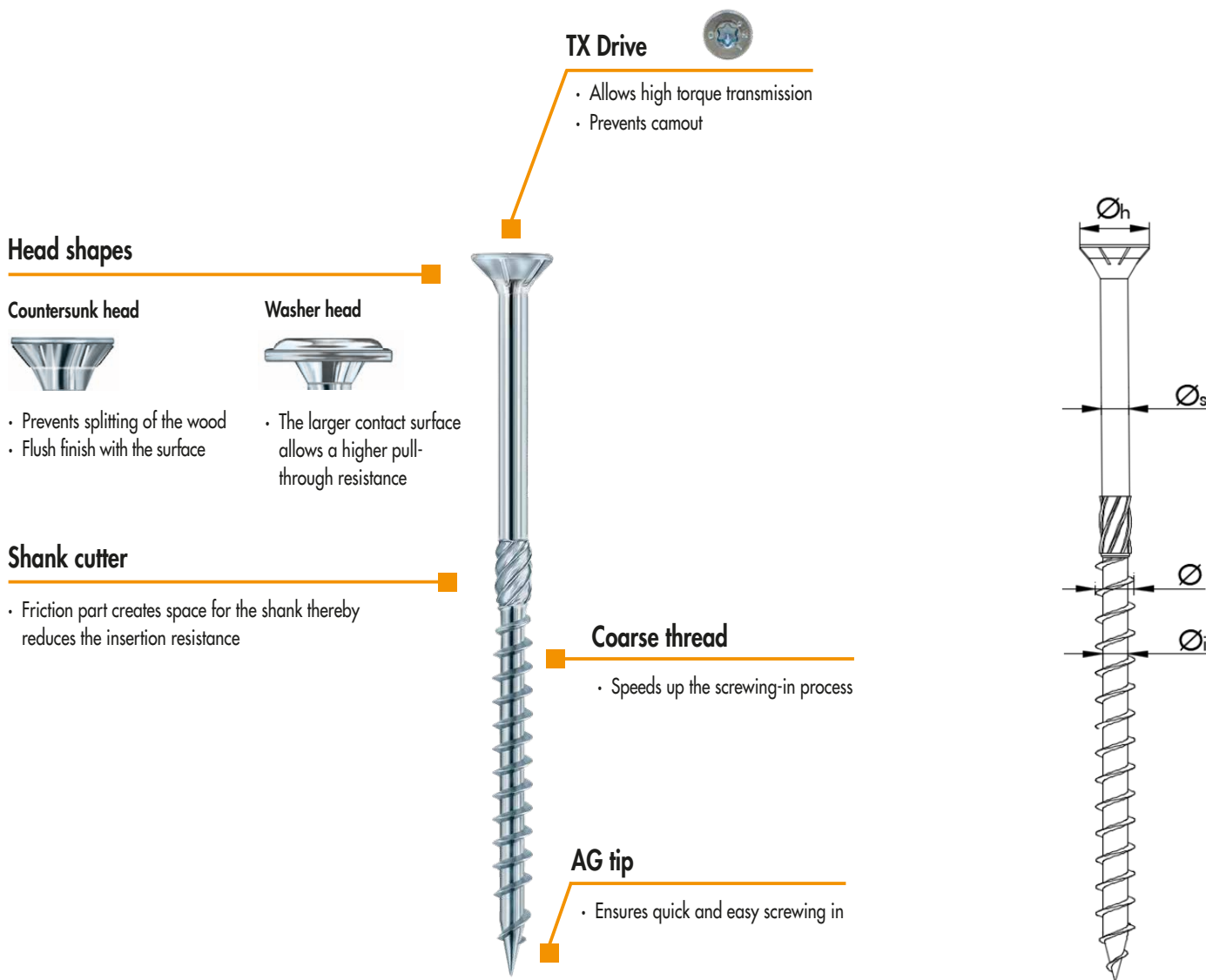

Paneltwistec AG Hardened Carbon Steel									
Geometric properties					Mechanical properties				
Nominal $\varnothing$ [mm]	Inner $\varnothing_i$ [mm]	Shaft $\varnothing_s$ [mm]	Head <sup>a)</sup> $\varnothing_h$ [mm]	Thread length with tip [mm]	$f_{tens,k}$ [kN]	$f_{ax,k}$ [MPa]	$f_{head,k}$ [MPa]	$M_{y,k}$ [Nm]	
6	4,0	4,3	12,0 / 14,0	24–70	11,0	11,4	12,0	9,5	
8	5,3	5,7	14,5 / 22,0	32–100	20,0	11,1	12,0	20,0	
10	6,3	6,9	18,0 / 25,0	40–100	28,0	10,8	12,0	35,8	

a) Countersunk head / Washer head

# MINIMUM DISTANCES FOR SHEAR LOADS

## Paneltwistec

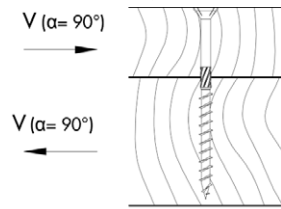
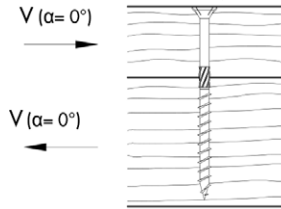

Ø [mm]	Predrilled holes				Predrilled holes			
	Rules	6	8	10	Rules	6	8	10
a <sub>1</sub>	5 · d	30	40	50	4 · d	24	32	40
a <sub>2</sub>	3 · d	18	24	30	4 · d	24	32	40
a <sub>3,c</sub>	7 · d	42	56	70	7 · d	42	56	70
a <sub>3,t</sub>	12 · d	72	96	120	7 · d	42	56	70
a <sub>4,c</sub>	3 · d	18	24	30	3 · d	18	24	30
a <sub>4,t</sub>	3 · d	18	24	30	7 · d	42	56	70

Ø [mm]	Non-predrilled holes				Non-predrilled holes			
	Rules	6	8	10	Rules	6	8	10
a <sub>1</sub>	12 · d	72	96	120	5 · d	30	40	50
a <sub>2</sub>	5 · d	30	40	50	5 · d	30	40	50
a <sub>3,c</sub>	10 · d	60	80	100	10 · d	60	80	100
a <sub>3,t</sub>	15 · d	90	120	150	10 · d	60	80	100
a <sub>4,c</sub>	5 · d	30	40	50	5 · d	30	40	50
a <sub>4,t</sub>	5 · d	30	40	50	10 · d	60	80	100

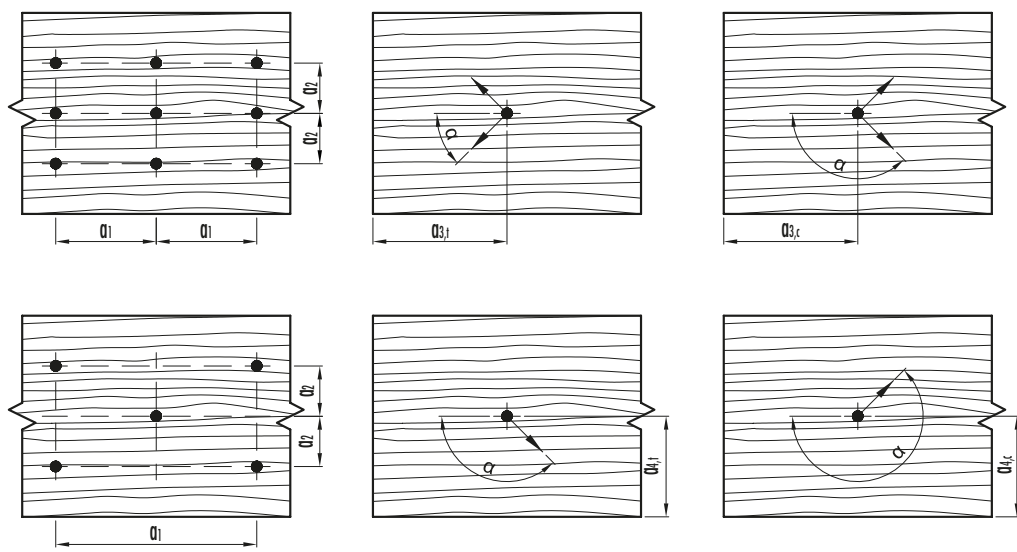

Notes: The minimum distances for axially-loaded screws are in accordance with ETA-11/0024 considering a softwood density of  $\rho_k \leq 420 \text{ kg/m}^3$ , where  $d$  = nominal screw diameter, minimum wood thickness,  $t = 10 \cdot d$  and minimum width,  $w = \max[8 \cdot d; 60 \text{ mm}]$ . For steel-to-timber joints, the axial spacings  $a_1$  and  $a_2$  can be reduced by a factor of 0,7. In wood members of Douglas fir, the minimum distances must be increased by 1,5. The edge distances and spacings of each timber member must be checked independently according to load and grain direction.

## PANELWISTEC AG COUNTERSUNK HEAD – TIMBER-TIMBER

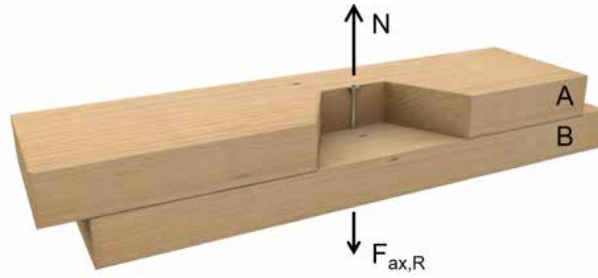
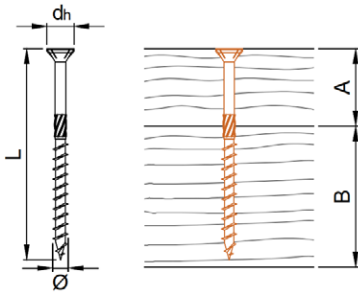

Axial load-carrying capacity of screws with minimum required lengths.

A [mm]	Ø 6 mm			Ø 8 mm			Ø 10 mm		
	F <sub>ax,Rk</sub> [kN]	F <sub>ax,Rd</sub> [kN]	L [mm]	F <sub>ax,Rk</sub> [kN]	F <sub>ax,Rd</sub> [kN]	L [mm]	F <sub>ax,Rk</sub> [kN]	F <sub>ax,Rd</sub> [kN]	L [mm]
24	1,73	1,06	60						
28	1,73	1,06	70						
30	1,73	1,06	80	2,52	1,55	80			
32	1,73	1,06	80	2,52	1,55	80			
36	1,73	1,06	90	2,52	1,55	100			
40	1,73	1,06	100	2,52	1,55	100	3,80	2,34	100
45	1,73	1,06	110	2,52	1,55	120	3,80	2,34	120
50	1,73	1,06	120	2,52	1,55	140	3,80	2,34	140
60	1,73	1,06	130	2,52	1,55	160	3,80	2,34	160
70	1,73	1,06	140	2,52	1,55	180	3,80	2,34	180
80	1,73	1,06	150	2,52	1,55	180	3,80	2,34	180
90	1,73	1,06	160	2,52	1,55	200	3,80	2,34	200
100	1,73	1,06	180	2,52	1,55	200	3,80	2,34	200
110	1,73	1,06	180	2,52	1,55	220	3,80	2,34	220
120	1,73	1,06	200	2,52	1,55	220	3,80	2,34	220
130	1,73	1,06	200	2,52	1,55	240	3,80	2,34	240
140	1,73	1,06	220	2,52	1,55	240	3,80	2,34	240
150	1,73	1,06	220	2,52	1,55	260	3,80	2,34	260
160	1,73	1,06	240	2,52	1,55	260	3,80	2,34	260
170	1,73	1,06	240	2,52	1,55	280	3,80	2,34	280
180	1,73	1,06	260	2,52	1,55	280	3,80	2,34	280
190	1,73	1,06	260	2,52	1,55	300	3,80	2,34	300
200	1,73	1,06	280	2,52	1,55	300	3,80	2,34	300
210	1,73	1,06	280	2,52	1,55	320	3,80	2,34	320
220	1,73	1,06	300	2,52	1,55	320	3,80	2,34	320
230	1,73	1,06	300	2,52	1,55	340	3,80	2,34	340
240				2,52	1,55	340	3,80	2,34	340
260				2,52	1,55	360	3,80	2,34	360
280				2,52	1,55	380	3,80	2,34	380
300				2,52	1,55	400	3,80	2,34	400
300				2,52	1,55	420	3,80	2,34	420
300				2,52	1,55	440	3,80	2,34	440
300				2,52	1,55	460	3,80	2,34	460
300				2,52	1,55	480	3,80	2,34	480
300				2,52	1,55	500	3,80	2,34	500
300				2,52	1,55	550	3,80	2,34	550
300				2,52	1,55	600	3,80	2,34	600

Calculated according to EN 1995-1-1, with non-pre-drilled holes and wood density  $\rho_k = 350 \text{ kg/m}^3$ .  $F_{ax,k}$  is limited by head pull-through resistance. Design values  $F_{ax,Rd}$  calculated considering  $k_{mod} = 0,8$  and  $\gamma_M = 1,3$ . Component B thickness is such that:  $B \geq L - A$ . L is the minimum screw length for achieving the respective load-carrying capacity.

Please note: these are planning aids. Projects must be calculated only by authorized persons.

## PANELWISTEC AG COUNTERSUNK HEAD – TIMBER-TIMBER

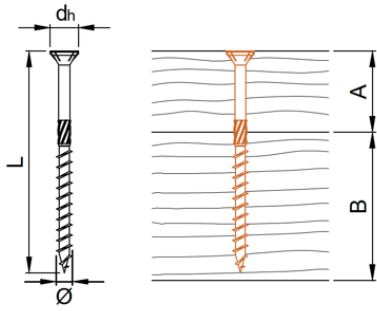

Lateral load-carrying capacity of screws with minimum required lengths.

A [mm]	Ø 6 mm			Ø 8 mm			Ø 10 mm		
	$F_{v,Rk}$ [kN]	$F_{v,Rd}$ [kN]	L [mm]	$F_{v,Rk}$ [kN]	$F_{v,Rd}$ [kN]	L [mm]	$F_{v,Rk}$ [kN]	$F_{v,Rd}$ [kN]	L [mm]
24	1,65	1,02	60						
28	1,75	1,08	70						
30	1,80	1,11	80	3,50	2,15	80			
32	1,85	1,14	80	3,61	2,22	80			
36	1,96	1,21	90	3,85	2,37	100			
40	2,02	1,24	100	3,97	2,44	100	5,45	3,35	100
45	2,02	1,24	110	3,97	2,44	120	5,82	3,58	120
50	2,02	1,24	120	3,97	2,44	140	5,90	3,63	140
60	2,02	1,24	130	3,97	2,44	160	5,90	3,63	160
70	2,02	1,24	140	3,97	2,44	180	5,90	3,63	180
80	2,02	1,24	150	3,97	2,44	180	5,90	3,63	180
90	2,02	1,24	160	3,97	2,44	200	5,90	3,63	200
100	2,02	1,24	180	3,97	2,44	200	5,90	3,63	200
110	2,02	1,24	180	3,97	2,44	220	5,90	3,63	220
120	2,02	1,24	200	3,97	2,44	220	5,90	3,63	220
130	2,02	1,24	200	3,97	2,44	240	5,90	3,63	240
140	2,02	1,24	220	3,97	2,44	240	5,90	3,63	240
150	2,02	1,24	220	3,97	2,44	260	5,90	3,63	260
160	2,02	1,24	240	3,97	2,44	260	5,90	3,63	260
170	2,02	1,24	240	3,97	2,44	280	5,90	3,63	280
180	2,02	1,24	260	3,97	2,44	280	5,90	3,63	280
190	2,02	1,24	260	3,97	2,44	300	5,90	3,63	300
200	2,02	1,24	280	3,97	2,44	300	5,90	3,63	300
210	2,02	1,24	280	3,97	2,44	320	5,90	3,63	320
220	2,02	1,24	300	3,97	2,44	320	5,90	3,63	320
230	2,02	1,24	300	3,97	2,44	340	5,90	3,63	340
240				3,97	2,44	340	5,90	3,63	340
260				3,97	2,44	360	5,90	3,63	360
280				3,97	2,44	380	5,90	3,63	380
300				3,97	2,44	400	5,90	3,63	400
300				3,97	2,44	420	5,90	3,63	420
300				3,97	2,44	440	5,90	3,63	440
300				3,97	2,44	460	5,90	3,63	460
300				3,97	2,44	480	5,90	3,63	480
300				3,97	2,44	500	5,90	3,63	500
300				3,97	2,44	550	5,90	3,63	550
300				3,97	2,44	600	5,90	3,63	600

Calculated according to EN 1995-1-1, with non-pre-drilled holes and wood density  $\rho_k = 380 \text{ kg/m}^3$ . Design values  $F_{v,Rd}$  calculated considering  $k_{mod} = 0,8$  and  $\gamma_M = 1,3$ . Component B thickness is such that:  $B \geq L - A$ . L is the minimum screw length for achieving the respective load-carrying capacity. **Please note:** These are planning aids. Projects must be calculated only by authorized persons.

## PANELWISTEC AG COUNTERSUNK HEAD – TIMBER-TIMBER



Lateral load-carrying capacity of screws with minimum required lengths.

A [mm]	Ø 6 mm			Ø 8 mm			Ø 10 mm		
	$F_{v,Rk}$ [kN]	$F_{v,Rd}$ [kN]	L [mm]	$F_{v,Rk}$ [kN]	$F_{v,Rd}$ [kN]	L [mm]	$F_{v,Rk}$ [kN]	$F_{v,Rd}$ [kN]	L [mm]
24	1,65	1,02	60						
28	1,75	1,08	70						
30	1,80	1,11	80	2,77	1,70	80			
32	1,85	1,14	80	2,84	1,75	80			
36	1,96	1,21	90	2,98	1,83	100			
40	2,02	1,24	100	3,14	1,93	100	4,22	2,60	100
45	2,02	1,24	110	3,34	2,06	120	4,44	2,73	120
50	2,02	1,24	120	3,39	2,09	140	4,67	2,87	140
60	2,02	1,24	130	3,39	2,09	160	4,99	3,07	160
70	2,02	1,24	140	3,39	2,09	180	4,99	3,07	180
80	2,02	1,24	150	3,39	2,09	180	4,99	3,07	180
90	2,02	1,24	160	3,39	2,09	200	4,99	3,07	200
100	2,02	1,24	180	3,39	2,09	200	4,99	3,07	200
110	2,02	1,24	180	3,39	2,09	220	4,99	3,07	220
120	2,02	1,24	200	3,39	2,09	220	4,99	3,07	220
130	2,02	1,24	200	3,39	2,09	240	4,99	3,07	240
140	2,02	1,24	220	3,39	2,09	240	4,99	3,07	240
150	2,02	1,24	220	3,39	2,09	260	4,99	3,07	260
160	2,02	1,24	240	3,39	2,09	260	4,99	3,07	260
170	2,02	1,24	240	3,39	2,09	280	4,99	3,07	280
180	2,02	1,24	260	3,39	2,09	280	4,99	3,07	280
190	2,02	1,24	260	3,39	2,09	300	4,99	3,07	300
200	2,02	1,24	280	3,39	2,09	300	4,99	3,07	300
210	2,02	1,24	280	3,39	2,09	320	4,99	3,07	320
220	2,02	1,24	300	3,39	2,09	320	4,99	3,07	320
230	2,02	1,24	300	3,39	2,09	340	4,99	3,07	340
240				3,39	2,09	340	4,99	3,07	340
260				3,39	2,09	360	4,99	3,07	360
280				3,39	2,09	380	4,99	3,07	380
300				3,39	2,09	400	4,99	3,07	400
300				3,39	2,09	420	4,99	3,07	420
300				3,39	2,09	440	4,99	3,07	440
300				3,39	2,09	460	4,99	3,07	460
300				3,39	2,09	480	4,99	3,07	480
300				3,39	2,09	500	4,99	3,07	500
300				3,39	2,09	550	4,99	3,07	550
300				3,39	2,09	600	4,99	3,07	600

Calculated according to EN 1995-1-1, with non-predrilled holes and wood density  $\rho_k = 380 \text{ kg/m}^3$ . Design values  $F_{v,Rd}$  calculated considering  $k_{mod} = 0,8$  and  $\gamma_M = 1,3$ . Component B thickness is such that:  $B \geq L - A$ . L is the minimum screw length for achieving the respective load-carrying capacity. **Please note:** These are planning aids. Projects must be calculated only by authorized persons.

## PANELWISTEC AG COUNTERSUNK HEAD – TIMBER-TIMBER

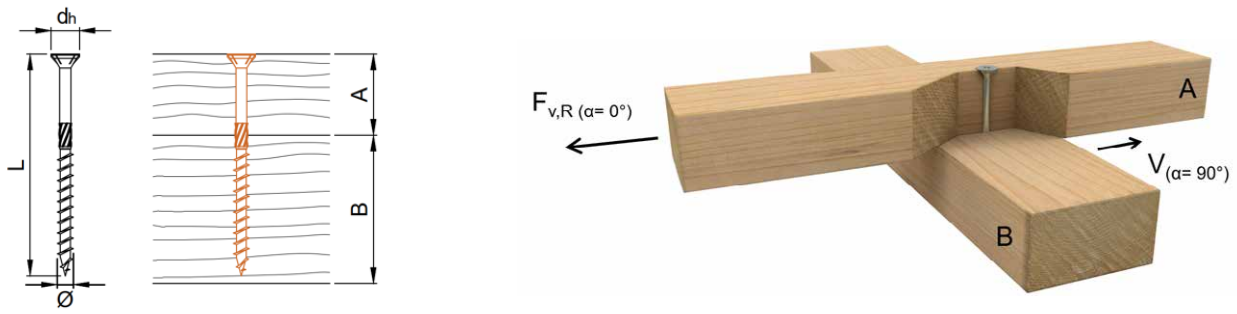

Lateral load-carrying capacity of screws with minimum required lengths.

A [mm]	Ø 6 mm			Ø 8 mm			Ø 10 mm		
	$F_{v,Rk}$ [kN]	$F_{v,Rd}$ [kN]	L [mm]	$F_{v,Rk}$ [kN]	$F_{v,Rd}$ [kN]	L [mm]	$F_{v,Rk}$ [kN]	$F_{v,Rd}$ [kN]	L [mm]
24	1,65	1,02	60						
28	1,75	1,08	70						
30	1,80	1,11	80	3,28	2,02	80			
32	1,85	1,14	80	3,39	2,09	80			
36	1,96	1,21	90	3,61	2,22	100			
40	2,02	1,24	100	3,64	2,24	100	5,09	3,13	100
45	2,02	1,24	110	3,64	2,24	120	5,37	3,30	120
50	2,02	1,24	120	3,64	2,24	140	5,37	3,30	140
60	2,02	1,24	130	3,64	2,24	160	5,37	3,30	160
70	2,02	1,24	140	3,64	2,24	180	5,37	3,30	180
80	2,02	1,24	150	3,64	2,24	180	5,37	3,30	180
90	2,02	1,24	160	3,64	2,24	200	5,37	3,30	200
100	2,02	1,24	180	3,64	2,24	200	5,37	3,30	200
110	2,02	1,24	180	3,64	2,24	220	5,37	3,30	220
120	2,02	1,24	200	3,64	2,24	220	5,37	3,30	220
130	2,02	1,24	200	3,64	2,24	240	5,37	3,30	240
140	2,02	1,24	220	3,64	2,24	240	5,37	3,30	240
150	2,02	1,24	220	3,64	2,24	260	5,37	3,30	260
160	2,02	1,24	240	3,64	2,24	260	5,37	3,30	260
170	2,02	1,24	240	3,64	2,24	280	5,37	3,30	280
180	2,02	1,24	260	3,64	2,24	280	5,37	3,30	280
190	2,02	1,24	260	3,64	2,24	300	5,37	3,30	300
200	2,02	1,24	280	3,64	2,24	300	5,37	3,30	300
210	2,02	1,24	280	3,64	2,24	320	5,37	3,30	320
220	2,02	1,24	300	3,64	2,24	320	5,37	3,30	320
230	2,02	1,24	300	3,64	2,24	340	5,37	3,30	340
240				3,64	2,24	340	5,37	3,30	340
260				3,64	2,24	360	5,37	3,30	360
280				3,64	2,24	380	5,37	3,30	380
300				3,64	2,24	400	5,37	3,30	400
300				3,64	2,24	420	5,37	3,30	420
300				3,64	2,24	440	5,37	3,30	440
300				3,64	2,24	460	5,37	3,30	460
300				3,64	2,24	480	5,37	3,30	480
300				3,64	2,24	500	5,37	3,30	500
300				3,64	2,24	550	5,37	3,30	550
300				3,64	2,24	600	5,37	3,30	600

Calculated according to EN 1995-1-1, with non-pre-drilled holes and wood density  $\rho_k = 380 \text{ kg/m}^3$ . Design values  $F_{Rd}$  calculated considering  $k_{mod} = 0,8$  and  $\gamma_M = 1,3$ . Component B thickness is such that:  $B \geq L - A$ . L is the minimum screw length for achieving the respective load-carrying capacity. **Please note:** These are planning aids. Projects must be calculated only by authorized persons.

## PANELWISTEC AG COUNTERSUNK HEAD – TIMBER-TIMBER

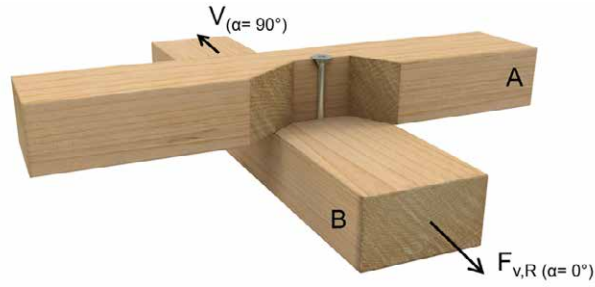
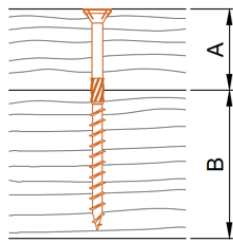
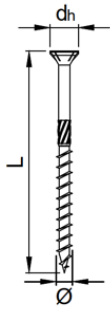

Lateral load-carrying capacity of screws with minimum required lengths.

A [mm]	Ø 6 mm			Ø 8 mm			Ø 10 mm		
	$F_{v,Rk}$ [kN]	$F_{v,Rd}$ [kN]	L [mm]	$F_{v,Rk}$ [kN]	$F_{v,Rd}$ [kN]	L [mm]	$F_{v,Rk}$ [kN]	$F_{v,Rd}$ [kN]	L [mm]
24	1,65	1,02	60						
28	1,75	1,08	70						
30	1,80	1,11	80	2,92	1,80	80			
32	1,85	1,14	80	2,99	1,84	80			
36	1,96	1,21	90	3,14	1,93	100			
40	2,02	1,24	100	3,30	2,03	100	4,46	2,74	100
45	2,02	1,24	110	3,51	2,16	120	4,69	2,89	120
50	2,02	1,24	120	3,64	2,24	140	4,93	3,03	140
60	2,02	1,24	130	3,64	2,24	160	5,37	3,30	160
70	2,02	1,24	140	3,64	2,24	180	5,37	3,30	180
80	2,02	1,24	150	3,64	2,24	180	5,37	3,30	180
90	2,02	1,24	160	3,64	2,24	200	5,37	3,30	200
100	2,02	1,24	180	3,64	2,24	200	5,37	3,30	200
110	2,02	1,24	180	3,64	2,24	220	5,37	3,30	220
120	2,02	1,24	200	3,64	2,24	220	5,37	3,30	220
130	2,02	1,24	200	3,64	2,24	240	5,37	3,30	240
140	2,02	1,24	220	3,64	2,24	240	5,37	3,30	240
150	2,02	1,24	220	3,64	2,24	260	5,37	3,30	260
160	2,02	1,24	240	3,64	2,24	260	5,37	3,30	260
170	2,02	1,24	240	3,64	2,24	280	5,37	3,30	280
180	2,02	1,24	260	3,64	2,24	280	5,37	3,30	280
190	2,02	1,24	260	3,64	2,24	300	5,37	3,30	300
200	2,02	1,24	280	3,64	2,24	300	5,37	3,30	300
210	2,02	1,24	280	3,64	2,24	320	5,37	3,30	320
220	2,02	1,24	300	3,64	2,24	320	5,37	3,30	320
230	2,02	1,24	300	3,64	2,24	340	5,37	3,30	340
240				3,64	2,24	340	5,37	3,30	340
260				3,64	2,24	360	5,37	3,30	360
280				3,64	2,24	380	5,37	3,30	380
300				3,64	2,24	400	5,37	3,30	400
300				3,64	2,24	420	5,37	3,30	420
300				3,64	2,24	440	5,37	3,30	440
300				3,64	2,24	460	5,37	3,30	460
300				3,64	2,24	480	5,37	3,30	480
300				3,64	2,24	500	5,37	3,30	500
300				3,64	2,24	550	5,37	3,30	550
300				3,64	2,24	600	5,37	3,30	600

Calculated according to EN 1995-1-1, with non-pre-drilled holes and wood density  $\rho_k = 380 \text{ kg/m}^3$ . Design values  $F_{Rd}$  calculated considering  $k_{mod} = 0,8$  and  $\gamma_M = 1,3$ . Component B thickness is such that:  $B \geq L - A$ . L is the minimum screw length for achieving the respective load-carrying capacity. **Please note:** These are planning aids. Projects must be calculated only by authorized persons.



## PANELWISTEC AG COUNTERSUNK HEAD – STEEL-TIMBER, THIN PLATE



Lateral load-carrying capacity of screws with minimum required lengths.

A [mm]	Ø 6 mm $t_s = 3$ mm			Ø 8 mm $t_s = 4$ mm			Ø 10 mm $t_s = 5$ mm		
	$F_{v,Rk}$ [kN]	$F_{v,Rd}$ [kN]	L [mm]	$F_{v,Rk}$ [kN]	$F_{v,Rd}$ [kN]	L [mm]	$F_{v,Rk}$ [kN]	$F_{v,Rd}$ [kN]	L [mm]
60	2,21	1,36	60						
70	2,31	1,42	70						
80	2,41	1,48	80	4,45	2,74	80			
90	2,51	1,54	90	4,45	2,74	80			
100	2,62	1,61	100	4,67	2,87	100	6,57	4,04	100
110	2,79	1,72	110	4,67	2,87	100	6,57	4,04	100
120	2,79	1,72	120	4,90	3,02	120	6,84	4,21	120
130	2,79	1,72	130	4,90	3,02	120	6,84	4,21	120
140	2,79	1,72	140	5,12	3,15	140	7,11	4,38	140
150	2,79	1,72	150	5,12	3,15	140	7,11	4,38	140
160	2,79	1,72	160	5,34	3,29	160	7,38	4,54	160
180	2,79	1,72	180	5,56	3,42	180	7,65	4,71	180
200	2,79	1,72	200	5,56	3,42	200	7,65	4,71	200
220	2,79	1,72	220	5,56	3,42	220	7,65	4,71	220
240	2,79	1,72	240	5,56	3,42	240	7,65	4,71	240
260	2,79	1,72	260	5,56	3,42	260	7,65	4,71	260
280	2,79	1,72	280	5,56	3,42	280	7,65	4,71	280
300	2,79	1,72	300	5,56	3,42	300	7,65	4,71	300
320				5,56	3,42	320	7,65	4,71	320
340				5,56	3,42	340	7,65	4,71	340
360				5,56	3,42	360	7,65	4,71	360
380				5,56	3,42	380	7,65	4,71	380
400				5,56	3,42	400	7,65	4,71	400
420				5,56	3,42	420	7,65	4,71	420
440				5,56	3,42	440	7,65	4,71	440
460				5,56	3,42	460	7,65	4,71	460
480				5,56	3,42	480	7,65	4,71	480
500				5,56	3,42	500	7,65	4,71	500
550				5,56	3,42	550	7,65	4,71	550
600				5,56	3,42	600	7,65	4,71	600

Calculated according to EN 1995-1-1, with non-predrilled holes and wood density  $\rho_k = 380$  kg/m<sup>3</sup>. Design values  $F_{Rd}$  calculated considering  $k_{mod} = 0,8$  and  $\gamma_M = 1,3$ . L is the minimum screw length for achieving the respective load-carrying capacity.

**Please note:** These are planning aids. Projects must be calculated only by authorized persons.

## PANELWISTEC AG COUNTERSUNK HEAD – STEEL-TIMBER, THIN PLATE



Lateral load-carrying capacity of screws with minimum required lengths

A [mm]	Ø 6 mm t <sub>s</sub> = 3 mm			Ø 8 mm t <sub>s</sub> = 4 mm			Ø 10 mm t <sub>s</sub> = 5 mm		
	α <sub>A</sub> = 90°								
	F <sub>v,Rk</sub> [kN]	F <sub>v,Rd</sub> [kN]	L [mm]	F <sub>v,Rk</sub> [kN]	F <sub>v,Rd</sub> [kN]	L [mm]	F <sub>v,Rk</sub> [kN]	F <sub>v,Rd</sub> [kN]	L [mm]
60	2,21	1,36	60						
70	2,31	1,42	70						
80	2,41	1,48	80	3,87	2,38	80			
90	2,51	1,54	90	3,87	2,38	80			
100	2,62	1,61	100	4,09	2,52	100	5,66	3,48	100
110	2,79	1,72	110	4,09	2,52	100	5,66	3,48	100
120	2,79	1,72	120	4,31	2,65	120	5,93	3,65	120
130	2,79	1,72	130	4,31	2,65	120	5,93	3,65	120
140	2,79	1,72	140	4,53	2,79	140	6,20	3,82	140
150	2,79	1,72	150	4,53	2,79	140	6,20	3,82	140
160	2,79	1,72	160	4,76	2,93	160	6,47	3,98	160
180	2,79	1,72	180	4,98	3,06	180	6,74	4,15	180
200	2,79	1,72	200	4,98	3,06	200	6,74	4,15	200
220	2,79	1,72	220	4,98	3,06	220	6,74	4,15	220
240	2,79	1,72	240	4,98	3,06	240	6,74	4,15	240
260	2,79	1,72	260	4,98	3,06	260	6,74	4,15	260
280	2,79	1,72	280	4,98	3,06	280	6,74	4,15	280
300	2,79	1,72	300	4,98	3,06	300	6,74	4,15	300
320				4,98	3,06	320	6,74	4,15	320
340				4,98	3,06	340	6,74	4,15	340
360				4,98	3,06	360	6,74	4,15	360
380				4,98	3,06	380	6,74	4,15	380
400				4,98	3,06	400	6,74	4,15	400
420				4,98	3,06	420	6,74	4,15	420
440				4,98	3,06	440	6,74	4,15	440
460				4,98	3,06	460	6,74	4,15	460
480				4,98	3,06	480	6,74	4,15	480
500				4,98	3,06	500	6,74	4,15	500
550				4,98	3,06	550	6,74	4,15	550
600				4,98	3,06	600	6,74	4,15	600

Calculated according to EN 1995-1-1, with non-pre-drilled holes and wood density ρ<sub>k</sub> = 380 kg/m<sup>3</sup>. Design values F<sub>Rd</sub> calculated considering k<sub>mod</sub> = 0,8 and γ<sub>M</sub> = 1,3. L is the minimum screw length for achieving the respective load-carrying capacity.

**Please note:** These are planning aids. Projects must be calculated only by authorized persons.

## PANELWISTEC AG COUNTERSUNK HEAD – STEEL-TIMBER, THICK PLATE

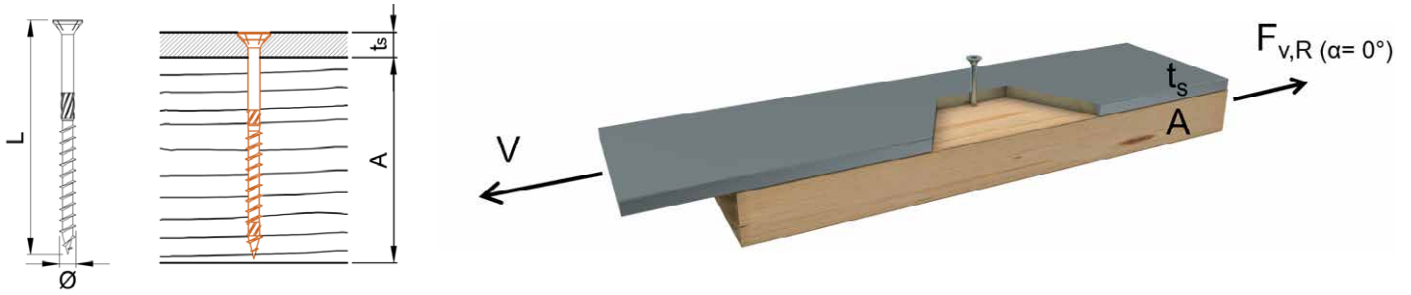

## Lateral load-carrying capacity of screws with minimum required lengths

A [mm]	Ø 6 mm 6 mm ≤ ts ≤ 9 mm			Ø 8 mm 8 mm ≤ ts ≤ 12 mm			Ø 10 mm 10 mm ≤ ts ≤ 15 mm		
	α <sub>A</sub> = 0°								
	F <sub>v,Rk</sub> [kN]	F <sub>v,Rd</sub> [kN]	L [mm]	F <sub>v,Rk</sub> [kN]	F <sub>v,Rd</sub> [kN]	L [mm]	F <sub>v,Rk</sub> [kN]	F <sub>v,Rd</sub> [kN]	L [mm]
60	2,86	1,76	60						
70	2,97	1,83	70						
80	3,07	1,89	80	5,84	3,59	80			
90	3,17	1,95	90	5,84	3,59	80			
100	3,27	2,01	100	6,06	3,73	100	8,61	5,30	100
110	3,45	2,12	110	6,06	3,73	100	8,61	5,30	100
120	3,45	2,12	120	6,28	3,86	120	8,88	5,46	120
130	3,45	2,12	130	6,28	3,86	120	8,88	5,46	120
140	3,45	2,12	140	6,50	4,00	140	9,15	5,63	140
150	3,45	2,12	150	6,50	4,00	140	9,15	5,63	140
160	3,45	2,12	160	6,73	4,14	160	9,42	5,80	160
180	3,45	2,12	180	6,95	4,28	180	9,69	5,96	180
200	3,45	2,12	200	6,95	4,28	200	9,69	5,96	200
220	3,45	2,12	220	6,95	4,28	220	9,69	5,96	220
240	3,45	2,12	240	6,95	4,28	240	9,69	5,96	240
260	3,45	2,12	260	6,95	4,28	260	9,69	5,96	260
280	3,45	2,12	280	6,95	4,28	280	9,69	5,96	280
300	3,45	2,12	300	6,95	4,28	300	9,69	5,96	300
320				6,95	4,28	320	9,69	5,96	320
340				6,95	4,28	340	9,69	5,96	340
360				6,95	4,28	360	9,69	5,96	360
380				6,95	4,28	380	9,69	5,96	380
400				6,95	4,28	400	9,69	5,96	400
420				6,95	4,28	420	9,69	5,96	420
440				6,95	4,28	440	9,69	5,96	440
460				6,95	4,28	460	9,69	5,96	460
480				6,95	4,28	480	9,69	5,96	480
500				6,95	4,28	500	9,69	5,96	500
550				6,95	4,28	550	9,69	5,96	550
600				6,95	4,28	600	9,69	5,96	600

Calculated according to EN 1995-1-1, with non-predrilled holes and wood density ρ<sub>k</sub> = 380 kg/m<sup>3</sup>. Design values F<sub>Rd</sub> calculated considering k<sub>mod</sub> = 0,8 and γ<sub>M</sub> = 1,3. L is the minimum screw length for achieving the respective load-carrying capacity.

**Please note:** These are planning aids. Projects must be calculated only by authorized persons.

## PANELWISTEC AG COUNTERSUNK HEAD – STEEL-TIMBER, THICK PLATE



Lateral load-carrying capacity of screws with minimum required lengths.

A [mm]	Ø 6 mm 6 mm ≤ ts ≤ 9 mm			Ø 8 mm 8 mm ≤ ts ≤ 12 mm			Ø 10 mm 10 mm ≤ ts ≤ 15 mm		
	α <sub>A</sub> = 90°								
	F <sub>v,Rk</sub> [kN]	F <sub>v,Rd</sub> [kN]	L [mm]	F <sub>v,Rk</sub> [kN]	F <sub>v,Rd</sub> [kN]	L [mm]	F <sub>v,Rk</sub> [kN]	F <sub>v,Rd</sub> [kN]	L [mm]
60	2,86	1,76	60						
70	2,97	1,83	70						
80	3,07	1,89	80	5,01	3,08	80			
90	3,19	1,96	90	5,01	3,08	80			
100	3,27	2,01	100	5,23	3,22	100	7,33	4,51	100
110	3,45	2,12	110	5,23	3,22	100	7,33	4,51	100
120	3,45	2,12	120	5,45	3,35	120	7,60	4,68	120
130	3,45	2,12	130	5,45	3,35	120	7,60	4,68	120
140	3,45	2,12	140	5,68	3,50	140	7,87	4,84	140
150	3,45	2,12	150	5,68	3,50	140	7,87	4,84	140
160	3,45	2,12	160	5,90	3,63	160	8,14	5,01	160
180	3,45	2,12	180	6,12	3,77	180	8,41	5,18	180
200	3,45	2,12	200	6,12	3,77	200	8,41	5,18	200
220	3,45	2,12	220	6,12	3,77	220	8,41	5,18	220
240	3,45	2,12	240	6,12	3,77	240	8,41	5,18	240
260	3,45	2,12	260	6,12	3,77	260	8,41	5,18	260
280	3,45	2,12	280	6,12	3,77	280	8,41	5,18	280
300	3,45	2,12	300	6,12	3,77	300	8,41	5,18	300
320				6,12	3,77	320	8,41	5,18	320
340				6,12	3,77	340	8,41	5,18	340
360				6,12	3,77	360	8,41	5,18	360
380				6,12	3,77	380	8,41	5,18	380
400				6,12	3,77	400	8,41	5,18	400
420				6,12	3,77	420	8,41	5,18	420
440				6,12	3,77	440	8,41	5,18	440
460				6,12	3,77	460	8,41	5,18	460
480				6,12	3,77	480	8,41	5,18	480
500				6,12	3,77	500	8,41	5,18	500
550				6,12	3,77	550	8,41	5,18	550
600				6,12	3,77	600	8,41	5,18	600

Calculated according to EN 1995-1-1, with non-predrilled holes and wood density ρ<sub>k</sub> = 380 kg/m<sup>3</sup>. Design values F<sub>v,Rd</sub> calculated considering k<sub>mod</sub> = 0,8 and γ<sub>M</sub> = 1,3. L is the minimum screw length for achieving the respective load-carrying capacity.

**Please note:** These are planning aids. Projects must be calculated only by authorized persons.

## PANELWISTEC AG WASHER HEAD – TIMBER-TIMBER



Axial load-carrying capacity of screws with minimum required lengths.

A [mm]	Ø 6 mm			Ø 8 mm			Ø 10 mm		
	$F_{v,Rk}$ [kN]	$F_{v,Rd}$ [kN]	L [mm]	$F_{v,Rk}$ [kN]	$F_{v,Rd}$ [kN]	L [mm]	$F_{v,Rk}$ [kN]	$F_{v,Rd}$ [kN]	L [mm]
24	2,35	1,45	60						
28	2,35	1,45	70						
30	2,35	1,45	80	4,44	2,73	80			
32	2,35	1,45	80	4,44	2,73	80			
36	2,35	1,45	90	4,88	3,00	100			
40	2,35	1,45	100	4,88	3,00	100	6,48	3,99	100
45	2,35	1,45	110	5,33	3,28	120	7,50	4,62	120
50	2,35	1,45	120	5,81	3,58	140	7,50	4,62	140
60	2,35	1,45	130	5,81	3,58	160	7,50	4,62	160
70	2,35	1,45	140	5,81	3,58	180	7,50	4,62	180
80	2,35	1,45	150	5,81	3,58	180	7,50	4,62	180
90	2,35	1,45	160	5,81	3,58	200	7,50	4,62	200
100	2,35	1,45	180	5,81	3,58	200	7,50	4,62	200
110	2,35	1,45	180	5,81	3,58	220	7,50	4,62	220
120	2,35	1,45	200	5,81	3,58	220	7,50	4,62	220
130	2,35	1,45	200	5,81	3,58	240	7,50	4,62	240
140	2,35	1,45	220	5,81	3,58	240	7,50	4,62	240
150	2,35	1,45	220	5,81	3,58	260	7,50	4,62	260
160	2,35	1,45	240	5,81	3,58	260	7,50	4,62	260
170	2,35	1,45	240	5,81	3,58	280	7,50	4,62	280
180	2,35	1,45	260	5,81	3,58	280	7,50	4,62	280
190	2,35	1,45	260	5,81	3,58	300	7,50	4,62	300
200	2,35	1,45	280	5,81	3,58	300	7,50	4,62	300
210	2,35	1,45	280	5,81	3,58	320	7,50	4,62	320
220	2,35	1,45	300	5,81	3,58	320	7,50	4,62	320
230	2,35	1,45	300	5,81	3,58	340	7,50	4,62	340
240				5,81	3,58	340	7,50	4,62	340
260				5,81	3,58	360	7,50	4,62	360
280				5,81	3,58	380	7,50	4,62	380
300				5,81	3,58	400	7,50	4,62	400
300				5,81	3,58	420	7,50	4,62	420
300				5,81	3,58	440	7,50	4,62	440
300				5,81	3,58	460	7,50	4,62	460
300				5,81	3,58	480	7,50	4,62	480
300				5,81	3,58	500	7,50	4,62	500
300				5,81	3,58	550	7,50	4,62	550
300				5,81	3,58	600	7,50	4,62	600

Calculated according to EN 1995-1-1, with non-pre-drilled holes and wood density  $\rho_k = 350 \text{ kg/m}^3$ .  $F_{ax,k}$  is limited by head pull-through resistance for most screw lengths. Design values  $F_{Rd}$  calculated considering  $k_{mod} = 0,8$  and  $\gamma_M = 1,3$ . Component B thickness is such that:  $B \geq L - A$ . L is the minimum screw length for achieving the respective load-carrying capacity.

Please note: these are planning aids. Projects must be calculated only by authorized persons.

## PANELWISTEC AG WASHER HEAD – TIMBER-TIMBER

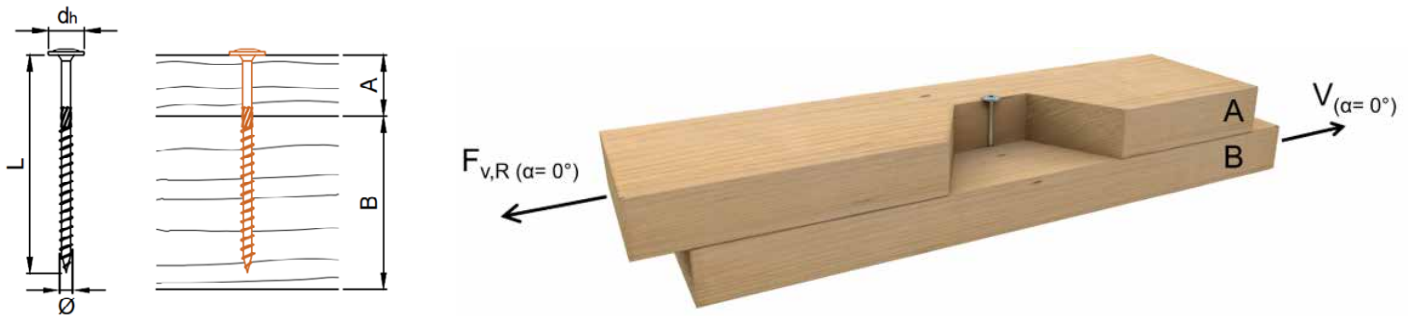

Lateral load-carrying capacity of screws with minimum required lengths.

A [mm]	Ø 6 mm			Ø 8 mm			Ø 10 mm		
	$F_{v,Rk}$ [kN]	$F_{v,Rd}$ [kN]	L [mm]	$F_{v,Rk}$ [kN]	$F_{v,Rd}$ [kN]	L [mm]	$F_{v,Rk}$ [kN]	$F_{v,Rd}$ [kN]	L [mm]
24	1,81	1,11	60						
28	1,91	1,17	70						
30	1,96	1,20	80	3,98	2,45	80			
32	2,01	1,23	80	4,09	2,52	80			
36	2,12	1,30	90	4,44	2,73	100			
40	2,18	1,34	100	4,56	2,81	100	6,12	3,77	100
45	2,18	1,34	110	4,67	2,88	120	6,75	4,15	120
50	2,18	1,34	120	4,79	2,95	140	6,83	4,20	140
60	2,18	1,34	130	4,79	2,95	160	6,83	4,20	160
70	2,18	1,34	140	4,79	2,95	180	6,83	4,20	180
80	2,18	1,34	150	4,79	2,95	180	6,83	4,20	180
90	2,18	1,34	160	4,79	2,95	200	6,83	4,20	200
100	2,18	1,34	180	4,79	2,95	200	6,83	4,20	200
110	2,18	1,34	180	4,79	2,95	220	6,83	4,20	220
120	2,18	1,34	200	4,79	2,95	220	6,83	4,20	220
130	2,18	1,34	200	4,79	2,95	240	6,83	4,20	240
140	2,18	1,34	220	4,79	2,95	240	6,83	4,20	240
150	2,18	1,34	220	4,79	2,95	260	6,83	4,20	260
160	2,18	1,34	240	4,79	2,95	260	6,83	4,20	260
170	2,18	1,34	240	4,79	2,95	280	6,83	4,20	280
180	2,18	1,34	260	4,79	2,95	280	6,83	4,20	280
190	2,18	1,34	260	4,79	2,95	300	6,83	4,20	300
200	2,18	1,34	280	4,79	2,95	300	6,83	4,20	300
210	2,18	1,34	280	4,79	2,95	320	6,83	4,20	320
220	2,18	1,34	300	4,79	2,95	320	6,83	4,20	320
230	2,18	1,34	300	4,79	2,95	340	6,83	4,20	340
240				4,79	2,95	340	6,83	4,20	340
260				4,79	2,95	360	6,83	4,20	360
280				4,79	2,95	380	6,83	4,20	380
300				4,79	2,95	400	6,83	4,20	400
300				4,79	2,95	420	6,83	4,20	420
300				4,79	2,95	440	6,83	4,20	440
300				4,79	2,95	460	6,83	4,20	460
300				4,79	2,95	480	6,83	4,20	480
300				4,79	2,95	500	6,83	4,20	500
300				4,79	2,95	550	6,83	4,20	550
300				4,79	2,95	600	6,83	4,20	600

Calculated according to EN 1995-1-1, with non-pre-drilled holes and wood density  $\rho_k = 380 \text{ kg/m}^3$ . Design values  $F_{v,Rd}$  calculated considering  $k_{mod} = 0,8$  and  $\gamma_M = 1,3$ . L is the minimum screw length for achieving the respective load-carrying capacity.  
**Please note:** These are planning aids. Projects must be calculated only by authorized persons.

## PANELWISTEC AG WASHER HEAD – TIMBER-TIMBER

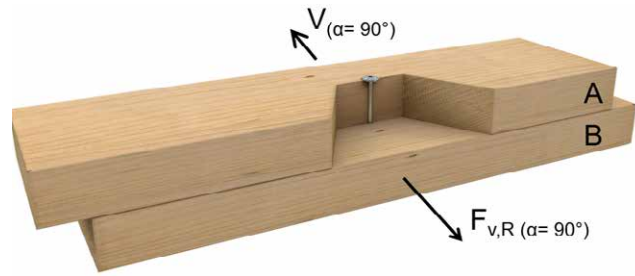
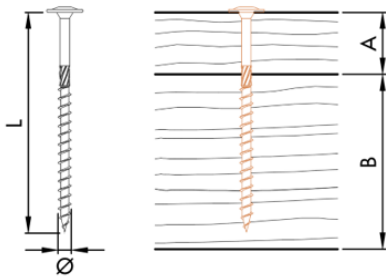

Lateral load-carrying capacity of screws with minimum required lengths.

A [mm]	Ø 6 mm			Ø 8 mm			Ø 10 mm		
	$F_{v,Rk}$ [kN]	$F_{v,Rd}$ [kN]	L [mm]	$F_{v,Rk}$ [kN]	$F_{v,Rd}$ [kN]	L [mm]	$F_{v,Rk}$ [kN]	$F_{v,Rd}$ [kN]	L [mm]
24	1,81	1,11	60						
28	1,91	1,17	70						
30	1,96	1,20	80	3,25	2,00	80			
32	2,01	1,23	80	3,32	2,04	80			
36	2,12	1,30	90	3,57	2,20	100			
40	2,18	1,34	100	3,73	2,30	100	4,89	3,01	100
45	2,18	1,34	110	4,04	2,49	120	5,37	3,30	120
50	2,18	1,34	120	4,21	2,59	140	5,60	3,44	140
60	2,18	1,34	130	4,21	2,59	160	5,92	3,64	160
70	2,18	1,34	140	4,21	2,59	180	5,92	3,64	180
80	2,18	1,34	150	4,21	2,59	180	5,92	3,64	180
90	2,18	1,34	160	4,21	2,59	200	5,92	3,64	200
100	2,18	1,34	180	4,21	2,59	200	5,92	3,64	200
110	2,18	1,34	180	4,21	2,59	220	5,92	3,64	220
120	2,18	1,34	200	4,21	2,59	220	5,92	3,64	220
130	2,18	1,34	200	4,21	2,59	240	5,92	3,64	240
140	2,18	1,34	220	4,21	2,59	240	5,92	3,64	240
150	2,18	1,34	220	4,21	2,59	260	5,92	3,64	260
160	2,18	1,34	240	4,21	2,59	260	5,92	3,64	260
170	2,18	1,34	240	4,21	2,59	280	5,92	3,64	280
180	2,18	1,34	260	4,21	2,59	280	5,92	3,64	280
190	2,18	1,34	260	4,21	2,59	300	5,92	3,64	300
200	2,18	1,34	280	4,21	2,59	300	5,92	3,64	300
210	2,18	1,34	280	4,21	2,59	320	5,92	3,64	320
220	2,18	1,34	300	4,21	2,59	320	5,92	3,64	320
230	2,18	1,34	300	4,21	2,59	340	5,92	3,64	340
240				4,21	2,59	340	5,92	3,64	340
260				4,21	2,59	360	5,92	3,64	360
280				4,21	2,59	380	5,92	3,64	380
300				4,21	2,59	400	5,92	3,64	400
300				4,21	2,59	420	5,92	3,64	420
300				4,21	2,59	440	5,92	3,64	440
300				4,21	2,59	460	5,92	3,64	460
300				4,21	2,59	480	5,92	3,64	480
300				4,21	2,59	500	5,92	3,64	500
300				4,21	2,59	550	5,92	3,64	550
300				4,21	2,59	600	5,92	3,64	600

Calculated according to EN 1995-1-1, with non-pre-drilled holes and wood density  $\rho_k = 380 \text{ kg/m}^3$ . Design values  $F_{v,Rd}$  calculated considering  $k_{mod} = 0,8$  and  $\gamma_{Mk} = 1,3$ . Component B thickness is such that:  $B \geq L - A$ . L is the minimum screw length for achieving the respective load-carrying capacity. **Please note:** these are planning aids. Projects must be calculated only by authorized persons.

## PANELWISTEC AG WASHER HEAD – TIMBER-TIMBER

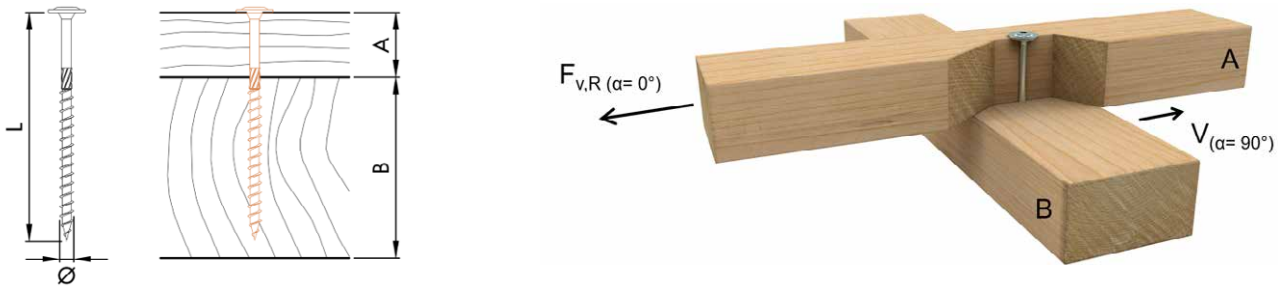

Lateral load-carrying capacity of screws with minimum required lengths.

	Ø 6 mm			Ø 8 mm			Ø 10 mm		
	$\alpha_A = 0^\circ$ $\alpha_B = 90^\circ$								
A [mm]	$F_{v,Rk}$ [kN]	$F_{v,Rd}$ [kN]	L [mm]	$F_{v,Rk}$ [kN]	$F_{v,Rd}$ [kN]	L [mm]	$F_{v,Rk}$ [kN]	$F_{v,Rd}$ [kN]	L [mm]
24	1,81	1,11	60						
28	1,91	1,17	70						
30	1,96	1,20	80	3,76	2,31	80			
32	2,01	1,23	80	3,87	2,38	80			
36	2,12	1,30	90	4,20	2,58	100			
40	2,18	1,34	100	4,23	2,60	100	5,76	3,54	100
45	2,18	1,34	110	4,34	2,67	120	6,30	3,87	120
50	2,18	1,34	120	4,46	2,75	140	6,30	3,87	140
60	2,18	1,34	130	4,46	2,75	160	6,30	3,87	160
70	2,18	1,34	140	4,46	2,75	180	6,30	3,87	180
80	2,18	1,34	150	4,46	2,75	180	6,30	3,87	180
90	2,18	1,34	160	4,46	2,75	200	6,30	3,87	200
100	2,18	1,34	180	4,46	2,75	200	6,30	3,87	200
110	2,18	1,34	180	4,46	2,75	220	6,30	3,87	220
120	2,18	1,34	200	4,46	2,75	220	6,30	3,87	220
130	2,18	1,34	200	4,46	2,75	240	6,30	3,87	240
140	2,18	1,34	220	4,46	2,75	240	6,30	3,87	240
150	2,18	1,34	220	4,46	2,75	260	6,30	3,87	260
160	2,18	1,34	240	4,46	2,75	260	6,30	3,87	260
170	2,18	1,34	240	4,46	2,75	280	6,30	3,87	280
180	2,18	1,34	260	4,46	2,75	280	6,30	3,87	280
190	2,18	1,34	260	4,46	2,75	300	6,30	3,87	300
200	2,18	1,34	280	4,46	2,75	300	6,30	3,87	300
210	2,18	1,34	280	4,46	2,75	320	6,30	3,87	320
220	2,18	1,34	300	4,46	2,75	320	6,30	3,87	320
230	2,18	1,34	300	4,46	2,75	340	6,30	3,87	340
240				4,46	2,75	340	6,30	3,87	340
260				4,46	2,75	360	6,30	3,87	360
280				4,46	2,75	380	6,30	3,87	380
300				4,46	2,75	400	6,30	3,87	400
300				4,46	2,75	420	6,30	3,87	420
300				4,46	2,75	440	6,30	3,87	440
300				4,46	2,75	460	6,30	3,87	460
300				4,46	2,75	480	6,30	3,87	480
300				4,46	2,75	500	6,30	3,87	500
300				4,46	2,75	550	6,30	3,87	550
300				4,46	2,75	600	6,30	3,87	600

Calculated according to EN 1995-1-1, with non-predrilled holes and wood density  $\rho_k = 380 \text{ kg/m}^3$ . Design values  $F_{Rd}$  calculated considering  $k_{mod} = 0,8$  and  $\gamma_M = 1,3$ . Component B thickness is such that:  $B \geq L - A$ . L is the minimum screw length for achieving the respective load-carrying capacity. **Please note:** these are planning aids. Projects must be calculated only by authorized persons.



## PANELWISTEC AG WASHER HEAD – TIMBER-TIMBER



Lateral load-carrying capacity of screws with minimum required lengths.

A [mm]	Ø 6 mm			Ø 8 mm			Ø 10 mm		
	$F_{v,Rk}$ [kN]	$F_{v,Rd}$ [kN]	L [mm]	$F_{v,Rk}$ [kN]	$F_{v,Rd}$ [kN]	L [mm]	$F_{v,Rk}$ [kN]	$F_{v,Rd}$ [kN]	L [mm]
24	1,81	1,11	60						
28	1,91	1,17	70						
30	1,96	1,20	80	3,40	2,09	80			
32	2,01	1,23	80	3,47	2,14	80			
36	2,12	1,30	90	3,73	2,30	100			
40	2,18	1,34	100	3,89	2,39	100	5,13	3,16	100
45	2,18	1,34	110	4,21	2,59	120	5,62	3,46	120
50	2,18	1,34	120	4,46	2,75	140	5,86	3,60	140
60	2,18	1,34	130	4,46	2,75	160	6,30	3,87	160
70	2,18	1,34	140	4,46	2,75	180	6,30	3,87	180
80	2,18	1,34	150	4,46	2,75	180	6,30	3,87	180
90	2,18	1,34	160	4,46	2,75	200	6,30	3,87	200
100	2,18	1,34	180	4,46	2,75	200	6,30	3,87	200
110	2,18	1,34	180	4,46	2,75	220	6,30	3,87	220
120	2,18	1,34	200	4,46	2,75	220	6,30	3,87	220
130	2,18	1,34	200	4,46	2,75	240	6,30	3,87	240
140	2,18	1,34	220	4,46	2,75	240	6,30	3,87	240
150	2,18	1,34	220	4,46	2,75	260	6,30	3,87	260
160	2,18	1,34	240	4,46	2,75	260	6,30	3,87	260
170	2,18	1,34	240	4,46	2,75	280	6,30	3,87	280
180	2,18	1,34	260	4,46	2,75	280	6,30	3,87	280
190	2,18	1,34	260	4,46	2,75	300	6,30	3,87	300
200	2,18	1,34	280	4,46	2,75	300	6,30	3,87	300
210	2,18	1,34	280	4,46	2,75	320	6,30	3,87	320
220	2,18	1,34	300	4,46	2,75	320	6,30	3,87	320
230	2,18	1,34	300	4,46	2,75	340	6,30	3,87	340
240				4,46	2,75	340	6,30	3,87	340
260				4,46	2,75	360	6,30	3,87	360
280				4,46	2,75	380	6,30	3,87	380
300				4,46	2,75	400	6,30	3,87	400
300				4,46	2,75	420	6,30	3,87	420
300				4,46	2,75	440	6,30	3,87	440
300				4,46	2,75	460	6,30	3,87	460
300				4,46	2,75	480	6,30	3,87	480
300				4,46	2,75	500	6,30	3,87	500
300				4,46	2,75	550	6,30	3,87	550
300				4,46	2,75	600	6,30	3,87	600

Calculated according to EN 1995-1-1, with non-predrilled holes and wood density  $\rho_k = 380 \text{ kg/m}^3$ . Design values  $F_{v,Rd}$  calculated considering  $k_{mod} = 0,8$  and  $\gamma_m = 1,3$ . Component B thickness is such that:  $B \geq L - A$ . L is the minimum screw length for achieving the respective load-carrying capacity. **Please note:** these are planning aids. Projects must be calculated only by authorized persons.

# PANELTWISTEC 1000

The high fidelity partially threaded screw for assembly



The Paneltwistec 1000 is a **hardened carbon steel** wood construction screw equipped with a **special notched screw tip and unique corrosion-resistant coating**. The cutting notch on the screw tip ensures fast gripping and less splitting effect when screwing in. Its **special coating withstands up to 1.000 hours of salt spray testing** according to **DIN EN ISO 9227 (NSS)**, achieving a **corrosivity category of C4 High/C5-M High** according to **DIN EN ISO 12944-6**. Additionally, it decreases the screwing friction. Paneltwistec 1000 screws are available in both countersunk head and washer head variants.

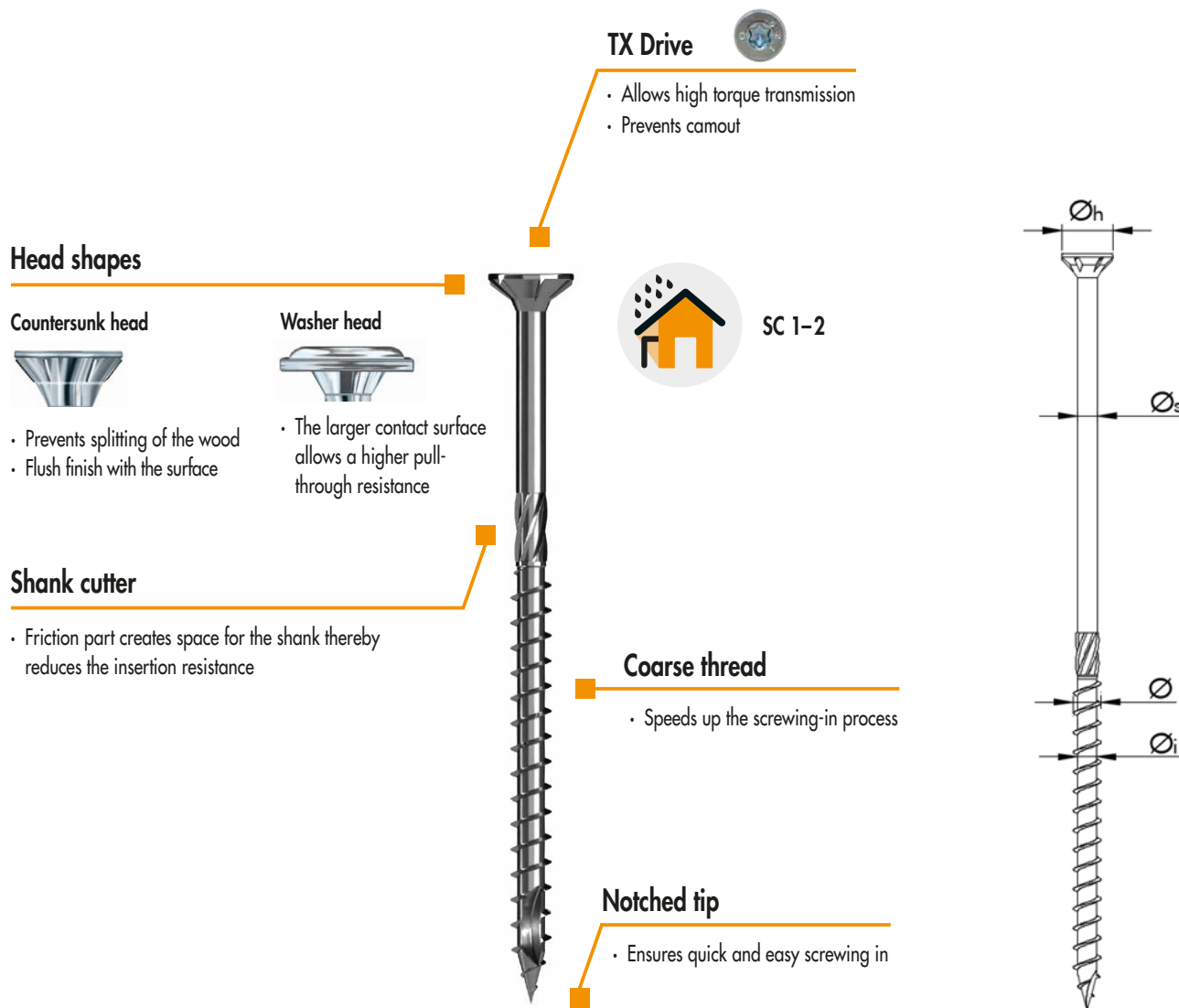

Paneltwistec 1000 Hardened Carbon Steel

Geometric properties					Mechanical properties			
Nominal Ø [mm]	Inner Ø <sub>i</sub> [mm]	Shaft Ø <sub>s</sub> [mm]	Head <sup>a)</sup> Ø <sub>h</sub> [mm]	Thread length with tip [mm]	f <sub>tens,k</sub> [kN]	f <sub>ax,k</sub> [MPa]	f <sub>head,k</sub> [MPa]	M <sub>y,k</sub> [Nm]
6	4,0	4,3	12,0–14,0	24–70	11,0	11,4	12,0	9,5
8	5,3	5,7	22,0	48–80	20,0	11,1	12,0	20,0
10	6,3	6,9	25,0	36–100	28,0	10,8	12,0	35,8

a) Countersunk head/Washer head. Ø 8 mm and Ø 10 mm only available in washer head version

**Note:** Check minimum distances and spacings on page 81.

## PANELTWISTEC 1000 COUNTERSUNK HEAD – TIMBER-TIMBER

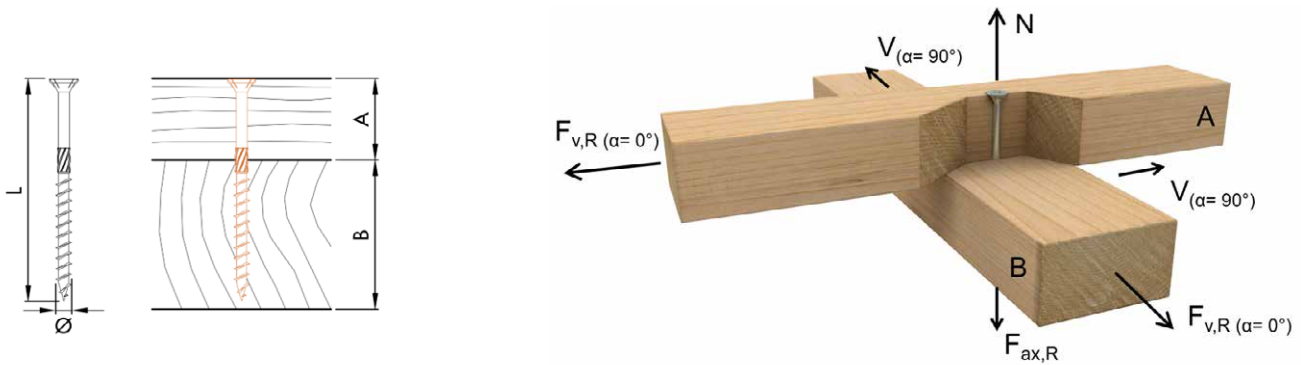

Axial and lateral load-carrying capacities of screws with minimum required lengths.

							Ø 6 mm		
				$\alpha_A = 90^\circ; \alpha_B = 0^\circ$ $\alpha_B = 0^\circ; \alpha_A = 90^\circ$					
A [mm]	$F_{ax,Rk}$ [kN]	$F_{v,Rd}$ [kN]	L [mm]	$F_{ax,Rk}$ [kN]	$F_{v,Rd}$ [kN]	L [mm]			
24	1,73	1,06	60	1,65	1,02	60			
28	1,73	1,06	70	1,75	1,08	70			
32	1,73	1,06	80	1,85	1,14	80			
36	1,73	1,06	90	1,96	1,21	90			
40	1,73	1,06	100	2,02	1,24	100			
50	1,73	1,06	120	2,02	1,24	120			
60	1,73	1,06	130	2,02	1,24	130			
70	1,73	1,06	140	2,02	1,24	140			
90	1,73	1,06	160	2,02	1,24	160			
110	1,73	1,06	180	2,02	1,24	180			
130	1,73	1,06	200	2,02	1,24	200			
150	1,73	1,06	220	2,02	1,24	220			
170	1,73	1,06	240	2,02	1,24	240			
190	1,73	1,06	260	2,02	1,24	260			
210	1,73	1,06	280	2,02	1,24	280			
230	1,73	1,06	300	2,02	1,24	300			

Calculated according to EN 1995-1-1, with non-pre-drilled holes and wood density  $\rho_k = 380 \text{ kg/m}^3$ . Design values  $F_{Rd}$  calculated considering  $k_{mod} = 0,8$  and  $\gamma_M = 1,3$ . Component B thickness is such that:  $B \geq L - A$ . L is the minimum screw length for achieving the respective load-carrying capacity.

**Please note:** These are planning aids. Projects must be calculated only by authorized persons.

## PANELTWISTEC 1000 COUNTERSUNK HEAD – TIMBER-TIMBER

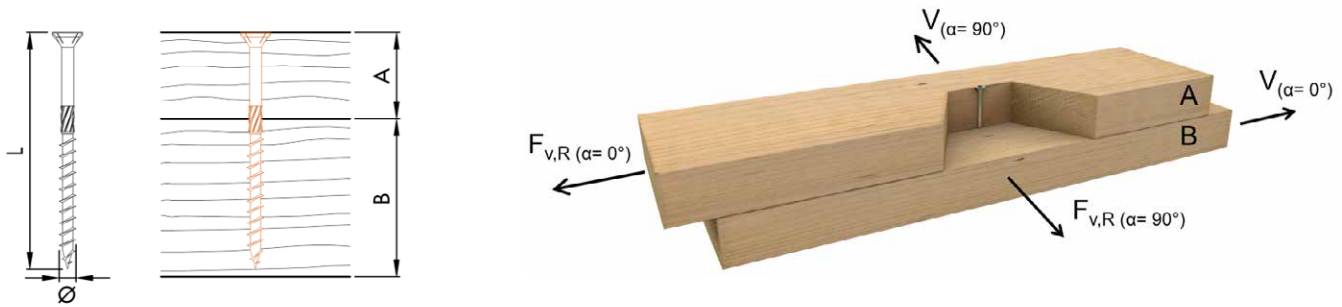

Axial and lateral load-carrying capacities of screws with minimum required lengths.

		Ø 6 mm		
		$\alpha_A = 0^\circ; \alpha_B = 90^\circ$ $\alpha_B = 0^\circ; \alpha_A = 90^\circ$		
A [mm]	$F_{v,Rk}$ [kN]	$F_{v,Rd}$ [kN]	L [mm]	
24	1,65	1,02	60	
28	1,75	1,08	70	
32	1,85	1,14	80	
36	1,96	1,21	90	
40	2,02	1,24	100	
50	2,02	1,24	120	
60	2,02	1,24	130	
70	2,02	1,24	140	
90	2,02	1,24	160	
110	2,02	1,24	180	
130	2,02	1,24	200	
150	2,02	1,24	220	
170	2,02	1,24	240	
190	2,02	1,24	260	
210	2,02	1,24	280	
230	2,02	1,24	300	

Calculated according to EN 1995-1-1, with non-predrilled holes and wood density  $\rho_k = 380 \text{ kg/m}^3$ . Design values  $F_{Rd}$  calculated considering  $k_{mod} = 0,8$  and  $\gamma_M = 1,3$ . Component B thickness is such that:  $B \geq L - A$ . L is the minimum screw length for achieving the respective load-carrying capacity.

**Please note:** These are planning aids. Projects must be calculated only by authorized persons.

## PANELTWISTEC 1000 COUNTERSUNK HEAD – STEEL-TIMBER

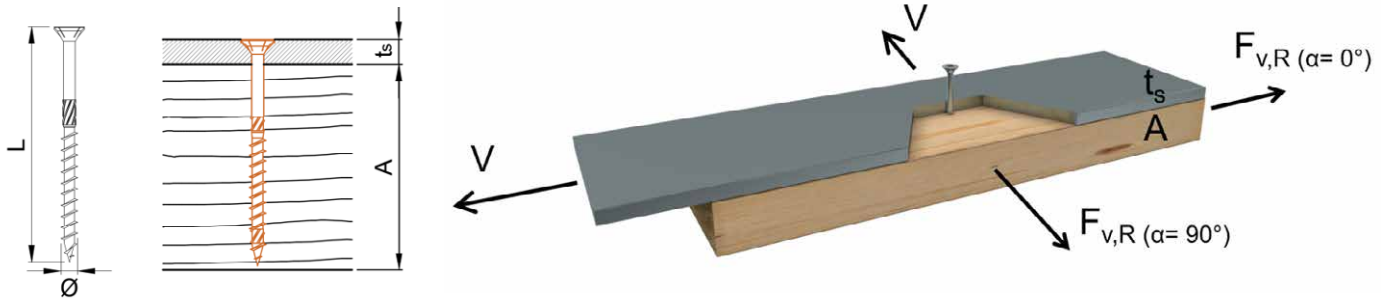

Lateral load-carrying capacity of screws with minimum required lengths.

A [mm]	Ø 6 mm $t_s = 3 \text{ mm}$			Ø 6 mm $6 \text{ mm} \leq t_s \leq 9 \text{ mm}$		
	$\alpha_A = 0^\circ; \alpha_A = 90^\circ$			$\alpha_A = 0^\circ; \alpha_A = 90^\circ$		
	$F_{v,Rk}$ [kN]	$F_{v,Rd}$ [kN]	L [mm]	$F_{v,Rk}$ [kN]	$F_{v,Rd}$ [kN]	L [mm]
60	2,21	1,36	60	2,86	1,76	60
70	2,31	1,42	70	2,97	1,83	70
80	2,41	1,48	80	3,07	1,89	80
90	2,51	1,54	90	3,17	1,95	90
100	2,62	1,61	100	3,27	2,01	100
120	2,79	1,72	120	3,45	2,12	120
130	2,79	1,72	130	3,45	2,12	130
140	2,79	1,72	140	3,45	2,12	140
160	2,79	1,72	160	3,45	2,12	160
180	2,79	1,72	180	3,45	2,12	180
200	2,79	1,72	200	3,45	2,12	200
220	2,79	1,72	220	3,45	2,12	220
240	2,79	1,72	240	3,45	2,12	240
260	2,79	1,72	260	3,45	2,12	260
280	2,79	1,72	280	3,45	2,12	280
300	2,79	1,72	300	3,45	2,12	300

Calculated according to EN 1995-1-1, with non-predrilled holes and wood density  $\rho_k = 380 \text{ kg/m}^3$ . Design values  $F_{v,Rd}$  calculated considering  $k_{mod} = 0,8$  and  $\gamma_M = 1,3$ . L is the minimum screw length for achieving the respective load-carrying capacity.

**Please note:** These are planning aids. Projects must be calculated only by authorized persons.

## PANELTWISTEC 1000 WASHER HEAD – TIMBER-TIMBER



Axial load-carrying capacity of screws with minimum required lengths.

A [mm]	Ø 6 mm			Ø 8 mm			Ø 10 mm		
	$F_{ax,Rk}$ [kN]	$F_{ax,Rd}$ [kN]	L [mm]	$F_{ax,Rk}$ [kN]	$F_{ax,Rd}$ [kN]	L [mm]	$F_{ax,Rk}$ [kN]	$F_{ax,Rd}$ [kN]	L [mm]
24							3,89	2,39	60
30				4,26	2,62	80	5,40	3,32	80
40	2,35	1,45	100	4,80	2,95	100	6,48	3,99	100
45	2,35	1,45	120	4,80	2,95	100	7,50	4,62	120
50	2,35	1,45	120	5,33	3,28	120	7,50	4,62	120
60	2,35	1,45	140	5,81	3,58	140	7,50	4,62	160
70	2,35	1,45	140	5,81	3,58	160	7,50	4,62	160
80	2,35	1,45	180	5,81	3,58	180	7,50	4,62	180
100	2,35	1,45	180	5,81	3,58	180	7,50	4,62	200
110	2,35	1,45	180	5,81	3,58	200	7,50	4,62	220
120	2,35	1,45	200	5,81	3,58	200	7,50	4,62	220
130	2,35	1,45	200	5,81	3,58	220	7,50	4,62	240
140				5,81	3,58	220	7,50	4,62	240
160				5,81	3,58	240			
180				5,81	3,58	260			
200				5,81	3,58	280			
220				5,81	3,58	300			
280				5,81	3,58	360			
320				5,81	3,58	400			

Calculated according to EN 1995-1-1, with non-pre-drilled holes and wood density  $\rho_k = 380 \text{ kg/m}^3$ . Design values  $F_{Rd}$  calculated considering  $k_{mod} = 0,8$  and  $\gamma_M = 1,3$ . Component B thickness is such that:  $B \geq L - A$ . L is the minimum screw length for achieving the respective load-carrying capacity.

**Please note:** these are planning aids. Projects must be calculated only by authorized persons.

## PANELTWISTEC 1000 WASHER HEAD – TIMBER-TIMBER

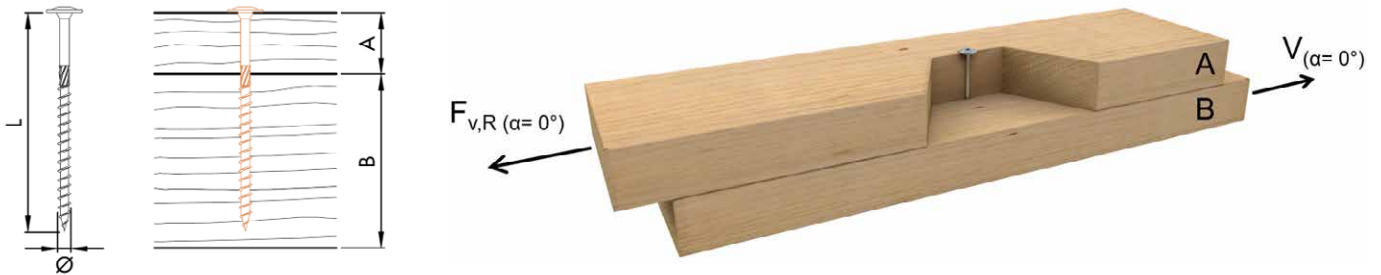

Lateral load-carrying capacity of screws with minimum required lengths.

A [mm]	Ø 6 mm			Ø 8 mm			Ø 10 mm		
	$F_{v,Rk}$ [kN]	$F_{v,Rd}$ [kN]	L [mm]	$F_{v,Rk}$ [kN]	$F_{v,Rd}$ [kN]	L [mm]	$F_{v,Rk}$ [kN]	$F_{v,Rd}$ [kN]	L [mm]
24							4,29	2,64	60
30				3,94	2,42	80	5,20	3,20	80
40	2,18	1,34	100	4,55	2,80	100	6,12	3,77	100
45	2,18	1,34	120	4,55	2,80	100	6,74	4,15	120
50	2,18	1,34	120	4,68	2,88	120	6,82	4,20	120
60	2,18	1,34	140	4,80	2,95	140	6,82	4,20	160
70	2,18	1,34	140	4,80	2,95	160	6,82	4,20	160
80	2,18	1,34	180	4,80	2,95	180	6,82	4,20	180
100	2,18	1,34	180	4,80	2,95	180	6,82	4,20	200
110	2,18	1,34	180	4,80	2,95	200	6,82	4,20	220
120	2,18	1,34	200	4,80	2,95	200	6,82	4,20	220
130	2,18	1,34	200	4,80	2,95	220	6,82	4,20	240
140				4,80	2,95	220	6,82	4,20	240
160				4,80	2,95	240			
180				4,80	2,95	260			
200				4,80	2,95	280			
220				4,80	2,95	300			
280				4,80	2,95	360			
320				4,80	2,95	400			

Calculated according to EN 1995-1-1, with non-predrilled holes and wood density  $\rho_k = 380 \text{ kg/m}^3$ . Design values  $F_{v,Rd}$  calculated considering  $k_{mod} = 0,8$  and  $\gamma_M = 1,3$ . Component B thickness is such that:  $B \geq L - A$ . L is the minimum screw length for achieving the respective load-carrying capacity.

**Please note:** these are planning aids. Projects must be calculated only by authorized persons.

## PANELTWISTEC 1000 WASHER HEAD – TIMBER-TIMBER



Lateral load-carrying capacity of screws with minimum required lengths.

A [mm]	Ø 6 mm			Ø 8 mm			Ø 10 mm		
	$\alpha_A = 90^\circ$ $\alpha_B = 90^\circ$								
	$F_{v,Rk}$ [kN]	$F_{v,Rd}$ [kN]	L [mm]	$F_{v,Rk}$ [kN]	$F_{v,Rd}$ [kN]	L [mm]	$F_{v,Rk}$ [kN]	$F_{v,Rd}$ [kN]	L [mm]
24							3,18	1,96	60
30				3,21	1,98	80	4,25	2,61	80
40	2,18	1,34	100	3,71	2,28	100	4,89	3,01	100
45	2,18	1,34	120	3,91	2,40	100	5,37	3,30	120
50	2,18	1,34	120	4,09	2,52	120	5,60	3,45	120
60	2,18	1,34	140	4,21	2,59	140	5,91	3,64	160
70	2,18	1,34	140	4,21	2,59	160	5,91	3,64	160
80	2,18	1,34	180	4,21	2,59	180	5,91	3,64	180
100	2,18	1,34	180	4,21	2,59	180	5,91	3,64	200
110	2,18	1,34	180	4,21	2,59	200	5,91	3,64	220
120	2,18	1,34	200	4,21	2,59	200	5,91	3,64	220
130	2,18	1,34	200	4,21	2,59	220	5,91	3,64	240
140				4,21	2,59	220	5,91	3,64	240
160				4,21	2,59	240			
180				4,21	2,59	260			
200				4,21	2,59	280			
220				4,21	2,59	300			
280				4,21	2,59	360			
320				4,21	2,59	400			

Calculated according to EN 1995-1-1, with non-predrilled holes and wood density  $\rho_k = 380 \text{ kg/m}^3$ . Design values  $F_{Rd}$  calculated considering  $k_{mod} = 0,8$  and  $\gamma_M = 1,3$ . Component B thickness is such that:  $B \geq L - A$ . L is the minimum screw length for achieving the respective load-carrying capacity.

**Please note:** these are planning aids. Projects must be calculated only by authorized persons.



## PANELTWISTEC 1000 WASHER HEAD – TIMBER-TIMBER

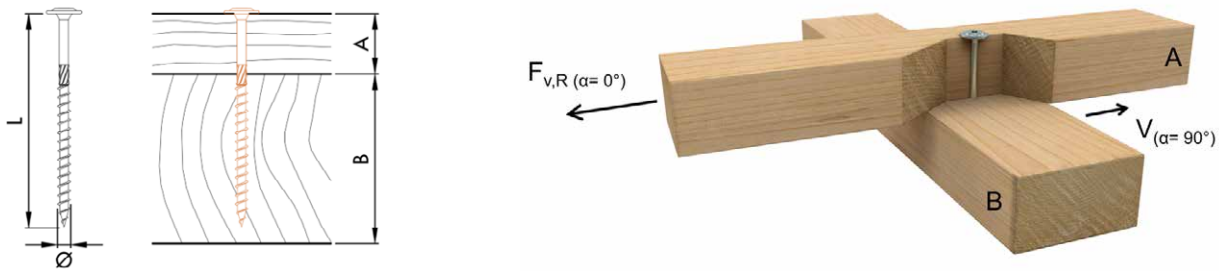

Lateral load-carrying capacity of screws with minimum required lengths.

A [mm]	Ø 6 mm			Ø 8 mm			Ø 10 mm		
	$F_{v,Rk}$ [kN]	$F_{v,Rd}$ [kN]	L [mm]	$F_{v,Rk}$ [kN]	$F_{v,Rd}$ [kN]	L [mm]	$F_{v,Rk}$ [kN]	$F_{v,Rd}$ [kN]	L [mm]
24							3,54	2,18	60
30				3,72	2,29	80	4,78	2,94	80
40	2,18	1,34	100	4,21	2,59	100	5,76	3,55	100
45	2,18	1,34	120	4,21	2,59	100	6,30	3,88	120
50	2,18	1,34	120	4,34	2,67	120	6,30	3,88	120
60	2,18	1,34	140	4,46	2,75	140	6,30	3,88	160
70	2,18	1,34	140	4,46	2,75	160	6,30	3,88	160
80	2,18	1,34	180	4,46	2,75	180	6,30	3,88	180
100	2,18	1,34	180	4,46	2,75	180	6,30	3,88	200
110	2,18	1,34	180	4,46	2,75	200	6,30	3,88	220
120	2,18	1,34	200	4,46	2,75	200	6,30	3,88	220
130	2,18	1,34	200	4,46	2,75	220	6,30	3,88	240
140				4,46	2,75	220	6,30	3,88	240
160				4,46	2,75	240			
180				4,46	2,75	260			
200				4,46	2,75	280			
220				4,46	2,75	300			
280				4,46	2,75	360			
320				4,46	2,75	400			

Calculated according to EN 1995-1-1, with non-predrilled holes and wood density  $\rho_k = 380 \text{ kg/m}^3$ . Design values  $F_{v,Rd}$  calculated considering  $k_{mod} = 0,8$  and  $\gamma_M = 1,3$ . Component B thickness is such that:  $B \geq L - A$ . L is the minimum screw length for achieving the respective load-carrying capacity.

**Please note:** these are planning aids. Projects must be calculated only by authorized persons.

## PANELTWISTEC 1000 WASHER HEAD – TIMBER-TIMBER

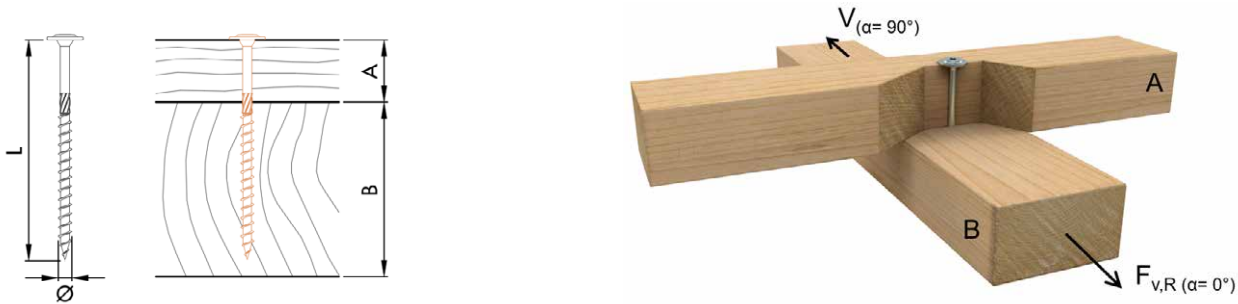

Lateral load-carrying capacity of screws with minimum required lengths.

	Ø 6 mm			Ø 8 mm			Ø 10 mm		
	$F_{v,Rk}$ [kN]	$F_{v,Rd}$ [kN]	L [mm]	$F_{v,Rk}$ [kN]	$F_{v,Rd}$ [kN]	L [mm]	$F_{v,Rk}$ [kN]	$F_{v,Rd}$ [kN]	L [mm]
	$\alpha_A = 90^\circ$ $\alpha_B = 0^\circ$								
A [mm]									
24							3,90	2,40	60
30				3,36	2,07	80	4,47	2,75	80
40	2,18	1,34	100	3,87	2,38	100	5,13	3,16	100
45	2,18	1,34	120	4,08	2,51	100	5,61	3,45	120
50	2,18	1,34	120	4,34	2,67	120	5,85	3,60	120
60	2,18	1,34	140	4,46	2,75	140	6,30	3,88	160
70	2,18	1,34	140	4,46	2,75	160	6,30	3,88	160
80	2,18	1,34	180	4,46	2,75	180	6,30	3,88	180
100	2,18	1,34	180	4,46	2,75	180	6,30	3,88	200
110	2,18	1,34	180	4,46	2,75	200	6,30	3,88	220
120	2,18	1,34	200	4,46	2,75	200	6,30	3,88	220
130	2,18	1,34	200	4,46	2,75	220	6,30	3,88	240
140				4,46	2,75	220	6,30	3,88	240
160				4,46	2,75	240			
180				4,46	2,75	260			
200				4,46	2,75	280			
220				4,46	2,75	300			
280				4,46	2,75	360			
320				4,46	2,75	400			

Calculated according to EN 1995-1-1, with non-predrilled holes and wood density  $\rho_k = 380 \text{ kg/m}^3$ . Design values  $F_{Rd}$  calculated considering  $k_{mod} = 0,8$  and  $\gamma_M = 1,3$ . Component B thickness is such that:  $B \geq L - A$ . L is the minimum screw length for achieving the respective load-carrying capacity.

**Please note:** these are planning aids. Projects must be calculated only by authorized persons.

# PANELTWISTEC INOX

The high fidelity partially threaded screw for assembly



The Paneltwistec Inox is a **hardened stainless steel** wood construction screw equipped with a **special notched screw tip**. The cutting notch on the screw tip **ensures fast gripping and less splitting effect** when screwing in. This type of steel **combines the best properties of carbon and stainless steel**, having **excellent corrosion resistance** with the high mechanical properties of galvanized steel. Paneltwistec Inox screws are available in both countersunk head and washer head variants.

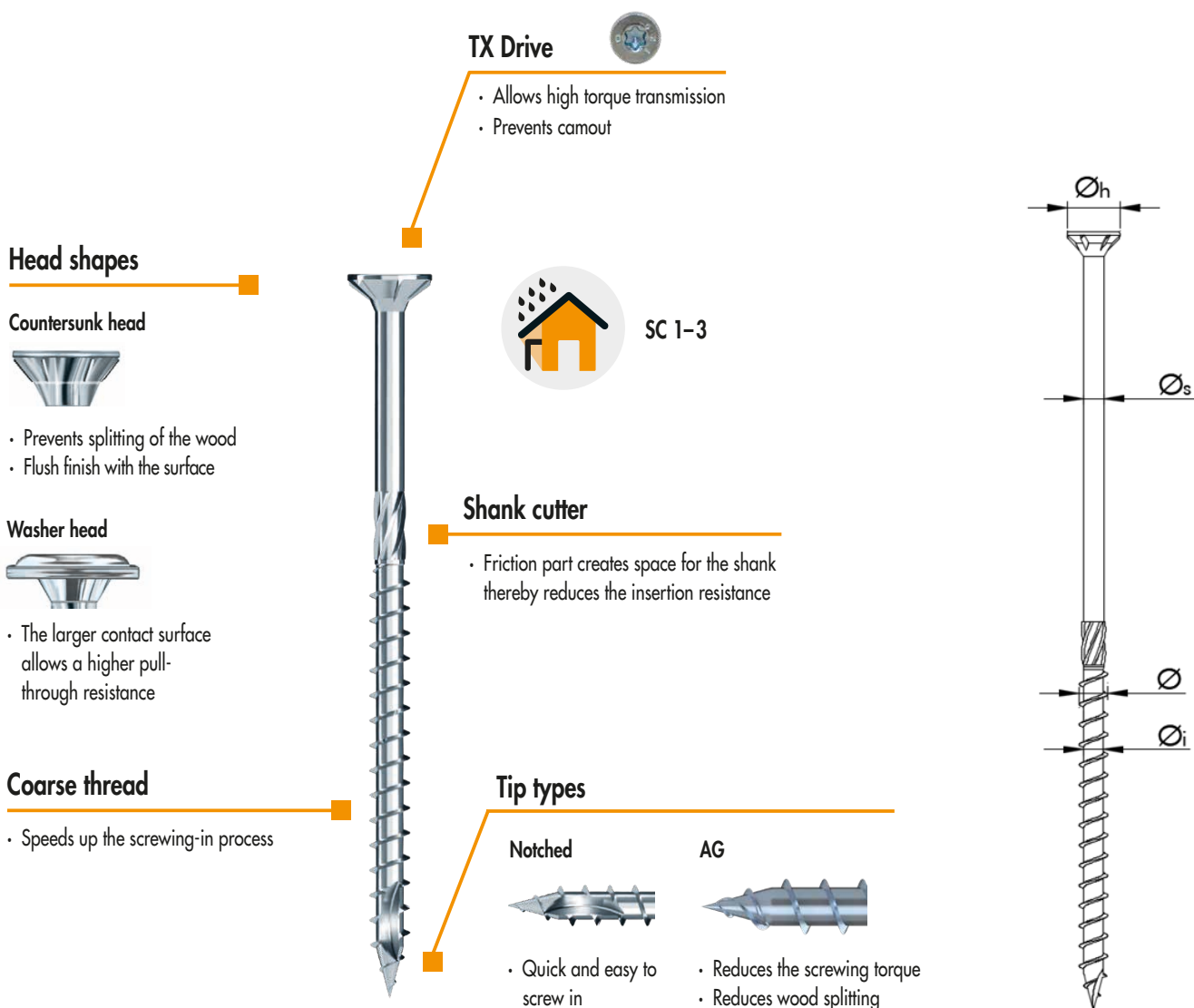

Paneltwistec Inox Hardened Stainless Steel

Geometric properties					Mechanical properties			
Nominal $\varnothing$ [mm]	Inner $\varnothing_i$ [mm]	Shaft $\varnothing_s$ [mm]	Head <sup>a)</sup> $\varnothing_h$ [mm]	Thread length with tip [mm]	$f_{tens,k}$ [kN]	$f_{ax,k}$ [MPa]	$f_{head,k}$ [MPa]	$M_{y,k}$ [Nm]
6	4,0	4,3	12,0 / 14,0	36-70	11,0	11,4	12,0	9,5
8	5,3	5,7	18,0	48-80	20,0	11,1	12,0	20,0

a) Countersunk head / Washer head.  $\varnothing$  8 mm and  $\varnothing$  10 mm only available in washer head version

**Note:** Check minimum distances and spacings on page 81.

## PANELTWISTEC INOX COUNTERSUNK HEAD – TIMBER TIMBER

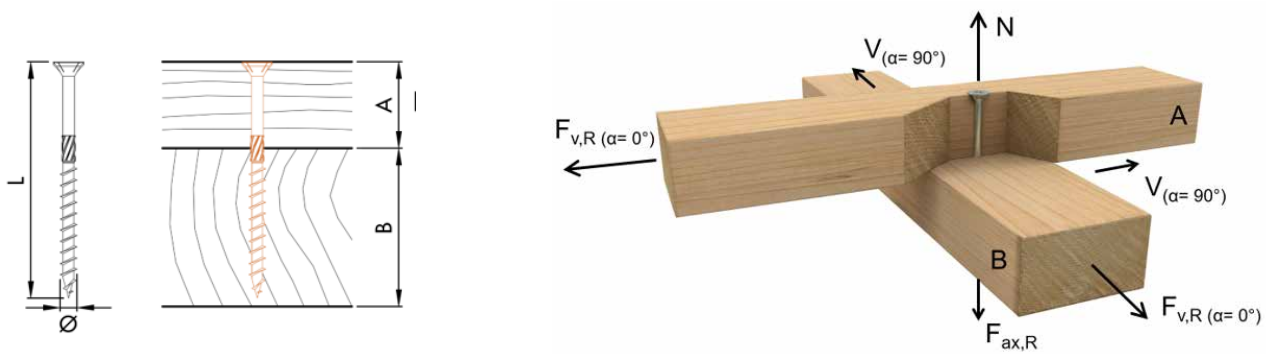

Axial and lateral load-carrying capacities of screws with minimum required lengths.

		Ø 6 mm				
		–		$\alpha_A = 0^\circ; \alpha_B = 90^\circ$ $\alpha_A = 90^\circ; \alpha_B = 0^\circ$		
A [mm]	$F_{ax,Rk}$ [kN]	$F_{ax,Rd}$ [kN]	L [mm]	$F_{v,Rk}$ [kN]	$F_{v,Rd}$ [kN]	L [mm]
24	1,73	1,06	60	1,65	1,02	60
28	1,73	1,06	70	1,75	1,08	70
32	1,73	1,06	80	1,85	1,14	80
36	1,73	1,06	90	1,96	1,21	90
40	1,73	1,06	100	2,02	1,24	100
50	1,73	1,06	120	2,02	1,24	120
60	1,73	1,06	130	2,02	1,24	130
70	1,73	1,06	140	2,02	1,24	140
90	1,73	1,06	160	2,02	1,24	160

Calculated according to EN 1995-1-1, with non-predrilled holes and wood density  $\rho_k = 380 \text{ kg/m}^3$ . Design values  $F_{Rd}$  calculated considering  $k_{mod} = 0,8$  and  $\gamma_M = 1,3$  and  $\gamma_{M2} = 1,25$ . Component B thickness is such that:  $B \geq L - A$ . L is the minimum screw length for achieving the respective load-carrying capacity.

**Please note:** These are planning aids. Projects must be calculated only by authorized persons.

## PANELTWISTEC INOX COUNTERSUNK HEAD – TIMBER TIMBER

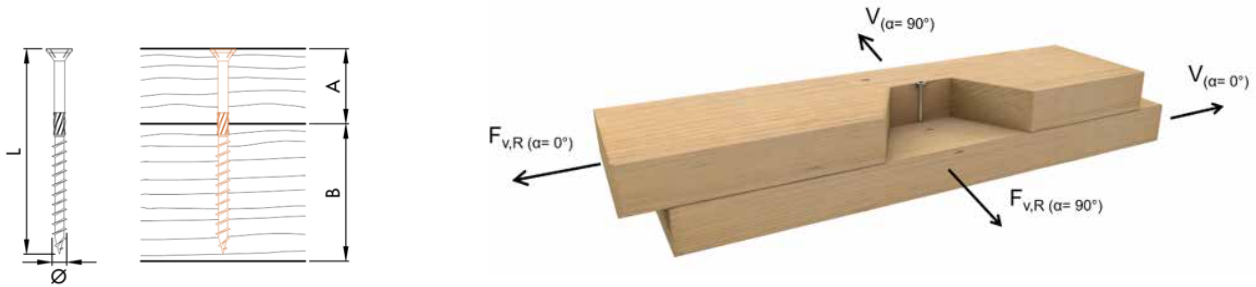

Axial and lateral load-carrying capacities of screws with minimum required lengths.

Ø 6 mm			
$\alpha_A = 0^\circ; \alpha_B = 0^\circ$ $\alpha_A = 90^\circ; \alpha_B = 90^\circ$			
A [mm]	$F_{v,Rk}$ [kN]	$F_{v,Rd}$ [kN]	L [mm]
24	1,65	1,02	60
28	1,75	1,08	70
32	1,85	1,14	80
36	1,96	1,21	90
40	2,02	1,24	100
50	2,02	1,24	120
60	2,02	1,24	130
70	2,02	1,24	140
90	2,02	1,24	160

Calculated according to EN 1995-1-1, with non-predrilled holes and wood density  $\rho_k = 380 \text{ kg/m}^3$ . Design values  $F_{Rd}$  calculated considering  $k_{mod} = 0,8$  and  $\gamma_M = 1,3$ . Component B thickness is such that:  $B \geq L - A$ . L is the minimum screw length for achieving the respective load-carrying capacity.

**Please note:** These are planning aids. Projects must be calculated only by authorized persons.

## PANELTWISTEC INOX COUNTERSUNK HEAD – STEEL-TIMBER

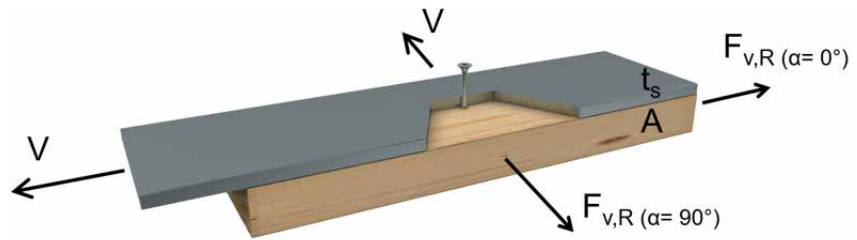
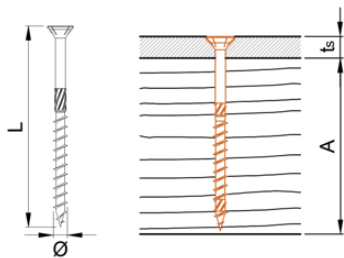

Lateral load-carrying capacity of screws with minimum required lengths.

A [mm]	Ø 6 mm $t_s = 3 \text{ mm}$			Ø 6 mm $6 \text{ mm} \leq t_s \leq 9 \text{ mm}$		
	$F_{v,Rk}$ [kN]	$F_{v,Rd}$ [kN]	L [mm]	$F_{v,Rk}$ [kN]	$F_{v,Rd}$ [kN]	L [mm]
60	2,21	1,36	60	2,86	1,76	60
70	2,31	1,42	70	2,97	1,83	70
80	2,41	1,48	80	3,07	1,89	80
90	2,51	1,54	90	3,17	1,95	90
100	2,62	1,61	100	3,27	2,01	100
120	2,79	1,72	120	3,45	2,12	120
130	2,79	1,72	130	3,45	2,12	130
140	2,79	1,72	140	3,45	2,12	140
160	2,79	1,72	160	3,45	2,12	160

Calculated according to EN 1995-1-1, with non-predrilled holes and wood density  $\rho_k = 380 \text{ kg/m}^3$ . Design values  $F_{v,Rd}$  calculated considering  $k_{mod} = 0,8$  and  $\gamma_M = 1,3$  and  $\gamma_{M2} = 1,25$ . L is the minimum screw length for achieving the respective load-carrying capacity.

**Please note:** These are planning aids. Projects must be calculated only by authorized persons.

## PANELTWISTEC INOX WASHER HEAD – TIMBER-TIMBER



Axial load-carrying capacities of screws with minimum required lengths.

A [mm]	Ø 6 mm			Ø 8 mm		
	$F_{ax,Rk}$ [kN]	$F_{ax,Rd}$ [kN]	L [mm]	$F_{ax,Rk}$ [kN]	$F_{ax,Rd}$ [kN]	L [mm]
24	2,35	1,45	60			
32	2,35	1,45	80	3,89	2,39	80
40	2,35	1,45	100	3,89	2,39	100
50	2,35	1,45	120	3,89	2,39	120
60	2,35	1,45	140	3,89	2,39	140
70	2,35	1,45	160	3,89	2,39	160
100				3,89	2,39	180
120				3,89	2,39	200
140				3,89	2,39	220
160				3,89	2,39	240
180				3,89	2,39	260
200				3,89	2,39	280
220				3,89	2,39	300
240				3,89	2,39	320
260				3,89	2,39	340
280				3,89	2,39	360
300				3,89	2,39	380
320				3,89	2,39	400

Calculated according to EN 1995-1-1, with non-predrilled holes and wood density  $\rho_k = 380 \text{ kg/m}^3$ . Design values  $F_{Rd}$  calculated considering  $k_{mod} = 0,8$  and  $\gamma_M = 1,3$ . Component B thickness is such that:  $B \geq L - A$ . L is the minimum screw length for achieving the respective load-carrying capacity.

**Please note:** these are planning aids. Projects must be calculated only by authorized persons.

## PANELTWISTEC INOX WASHER HEAD – TIMBER-TIMBER

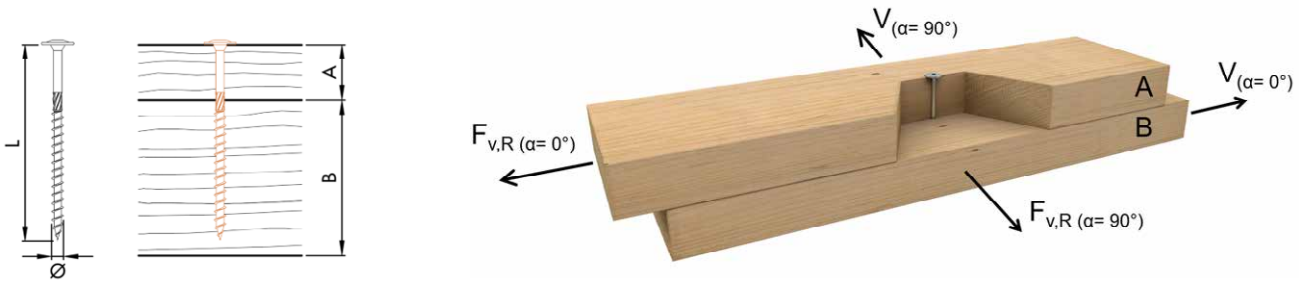

Lateral load-carrying capacity of screws with minimum required lengths.

A [mm]	Ø 6 mm			Ø 8 mm			Ø 6 mm			Ø 8 mm		
	$\alpha_A = 0^\circ$ $\alpha_B = 0^\circ$						$\alpha_A = 90^\circ$ $\alpha_B = 90^\circ$					
	$F_{v,Rk}$ [kN]	$F_{v,Rd}$ [kN]	L [mm]	$F_{v,Rk}$ [kN]	$F_{v,Rd}$ [kN]	L [mm]	$F_{v,Rk}$ [kN]	$F_{v,Rd}$ [kN]	L [mm]	$F_{v,Rk}$ [kN]	$F_{v,Rd}$ [kN]	L [mm]
24	1,81	1,11	60				1,81	1,11	60			
32	2,01	1,23	80	3,96	2,43	80	2,01	1,23	80	3,18	1,96	80
40	2,18	1,34	100	4,32	2,66	100	2,18	1,34	100	3,48	2,14	100
50	2,18	1,34	120	4,32	2,66	120	2,18	1,34	120	3,73	2,30	120
60	2,18	1,34	140	4,32	2,66	140	2,18	1,34	140	3,73	2,30	140
70	2,18	1,34	160	4,32	2,66	160	2,18	1,34	160	3,73	2,30	160
100				4,32	2,66	180				3,73	2,30	180
120				4,32	2,66	200				3,73	2,30	200
140				4,32	2,66	220				3,73	2,30	220
160				4,32	2,66	240				3,73	2,30	240
180				4,32	2,66	260				3,73	2,30	260
200				4,32	2,66	280				3,73	2,30	280
220				4,32	2,66	300				3,73	2,30	300
240				4,32	2,66	320				3,73	2,30	320
260				4,32	2,66	340				3,73	2,30	340
280				4,32	2,66	360				3,73	2,30	360
300				4,32	2,66	380				3,73	2,30	380
320				4,32	2,66	400				3,73	2,30	400

Calculated according to EN 1995-1-1, with non-pre-drilled holes and wood density  $\rho_k = 380 \text{ kg/m}^3$ . Design values  $F_{v,Rd}$  calculated considering  $k_{mod} = 0,8$  and  $\gamma_M = 1,3$ . Component B thickness is such that:  $B \geq L - A$ . L is the minimum screw length for achieving the respective load-carrying capacity.

**Please note:** These are planning aids. Projects must be calculated only by authorized persons.



## PANELTWISTEC INOX WASHER HEAD – TIMBER-TIMBER

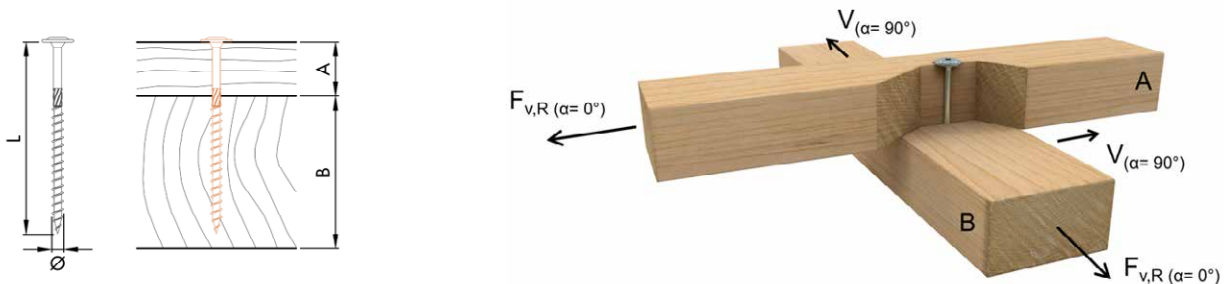

Lateral load-carrying capacity of screws with minimum required lengths.

A [mm]	Ø 6 mm			Ø 8 mm			Ø 6 mm			Ø 8 mm		
	$\alpha_A = 0^\circ$ $\alpha_B = 90^\circ$						$\alpha_A = 90^\circ$ $\alpha_B = 0^\circ$					
	$F_{v,Rk}$ [kN]	$F_{v,Rd}$ [kN]	L [mm]	$F_{v,Rk}$ [kN]	$F_{v,Rd}$ [kN]	L [mm]	$F_{v,Rk}$ [kN]	$F_{v,Rd}$ [kN]	L [mm]	$F_{v,Rk}$ [kN]	$F_{v,Rd}$ [kN]	L [mm]
24	1,81	1,11	60				1,81	1,11	60			
32	2,01	1,23	80	3,73	2,29	80	2,01	1,23	80	3,34	2,05	80
40	2,18	1,34	100	3,98	2,45	100	2,18	1,34	100	3,65	2,24	100
50	2,18	1,34	120	3,98	2,45	120	2,18	1,34	120	3,98	2,45	120
60	2,18	1,34	140	3,98	2,45	140	2,18	1,34	140	3,98	2,45	140
70	2,18	1,34	160	3,98	2,45	160	2,18	1,34	160	3,98	2,45	160
100				3,98	2,45	180				3,98	2,45	180
120				3,98	2,45	200				3,98	2,45	200
140				3,98	2,45	220				3,98	2,45	220
160				3,98	2,45	240				3,98	2,45	240
180				3,98	2,45	260				3,98	2,45	260
200				3,98	2,45	280				3,98	2,45	280
220				3,98	2,45	300				3,98	2,45	300
240				3,98	2,45	320				3,98	2,45	320
260				3,98	2,45	340				3,98	2,45	340
280				3,98	2,45	360				3,98	2,45	360
300				3,98	2,45	380				3,98	2,45	380
320				3,98	2,45	400				3,98	2,45	400

Calculated according to EN 1995-1-1, with non-pre-drilled holes and wood density  $\rho_k = 380 \text{ kg/m}^3$ . Design values  $F_{v,Rd}$  calculated considering  $k_{mod} = 0,8$  and  $\gamma_M = 1,3$ . Component B thickness is such that:  $B \geq L - A$ . L is the minimum screw length for achieving the respective load-carrying capacity.

**Please note:** These are planning aids. Projects must be calculated only by authorized persons.

# PANELTWISTEC A2 / A4

The high fidelity partially threaded screw for assembly



The Paneltwistec A2 / A4 are stainless steel wood construction screws equipped with a **special notched screw tip**. A2 steel has exceptional corrosion resistant towards weathering and coastal exposure, although are not suitable for long-term use with high-tanning hardwood species. A4 instead is the corrosion-resistant steel by excellence, being suitable for practically all environments. Paneltwistec A2 / A4 screws are available in both countersunk head and washer head variants..

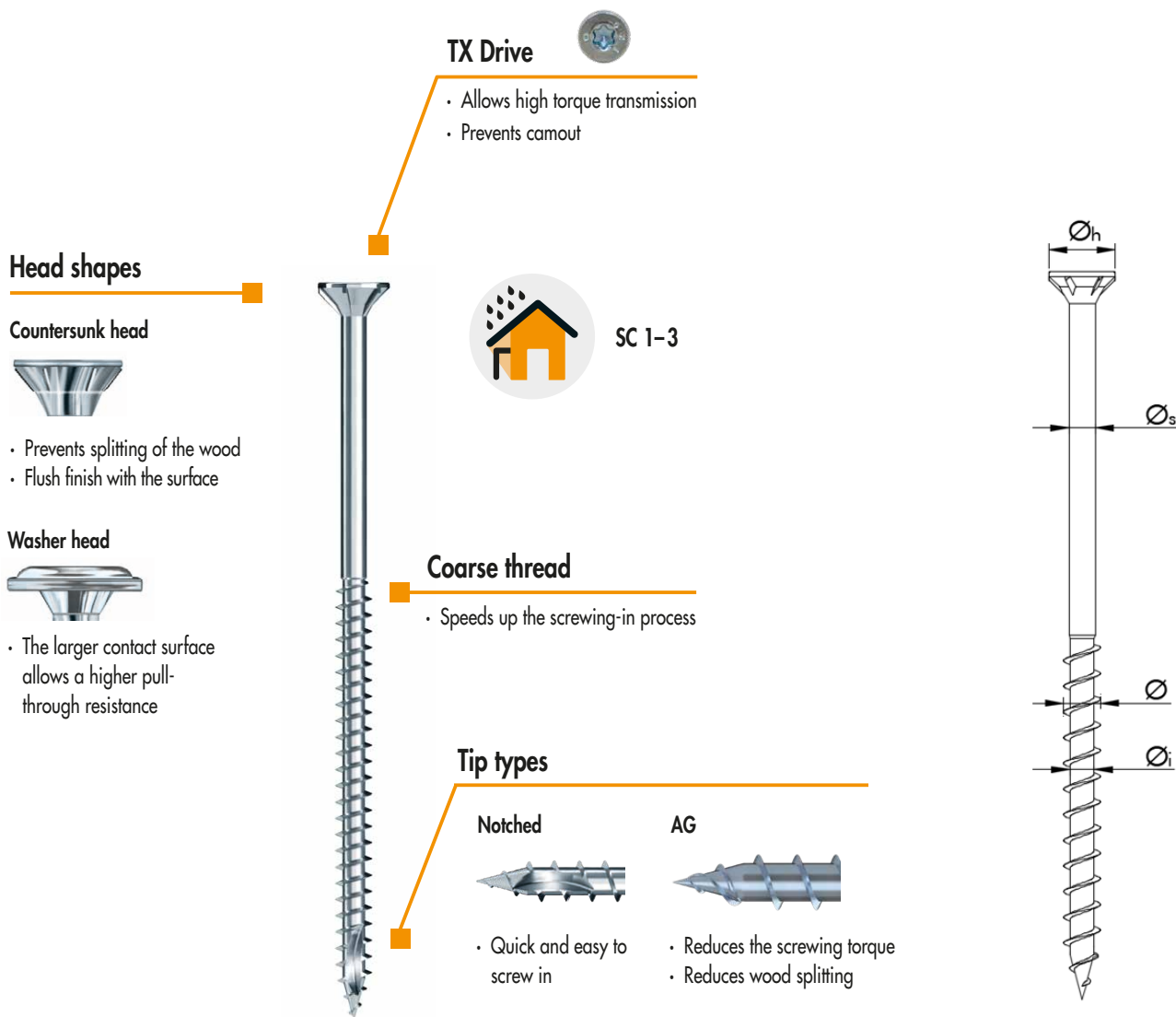

Paneltwistec Stainless Steel A2 / A4

Geometric properties					Mechanical properties				
Nominal $\varnothing$ [mm]	Inner $\varnothing_i$ [mm]	Shaft $\varnothing_s$ [mm]	Head <sup>a)</sup> $\varnothing_h$ [mm]	Thread length with tip [mm]	$f_{tens,k}$ [kN]	$f_{ax,k}$ [MPa]	$f_{head,k}$ [MPa]	$M_{y,k}$ [Nm]	
6	4,0	4,3	12,0	36-70	6,2	11,4	12,0	5,0	
8	5,3	5,7	14,5 / 16,0	48-80	11,0	11,1	12,0	10,7	

a) Countersunk head / Washer head.  $\varnothing_6$  mm only available in countersunk head version and A4 stainless steel.

**Note:** Check minimum distances and spacings on page 81.

## PANELTWISTEC A2 / A4 COUNTERSUNK HEAD – TIMBER-TIMBER



Axial load-carrying capacity of screws with minimum required lengths.

A [mm]	Ø 6 mm			Ø 8 mm		
	$F_{ax,Rk}$ [kN]	$F_{ax,Rd}$ [kN]	L [mm]	$F_{ax,Rk}$ [kN]	$F_{ax,Rd}$ [kN]	L [mm]
24	1,73	1,06	60			
28	1,73	1,06	70			
30	1,73	1,06	80	2,52	1,55	80
32	1,73	1,06	80	2,52	1,55	80
36	1,73	1,06	100	2,52	1,55	100
40	1,73	1,06	100	2,52	1,55	100
45	1,73	1,06	120	2,52	1,55	120
50	1,73	1,06	120	2,52	1,55	140
60				2,52	1,55	160
70				2,52	1,55	180
80				2,52	1,55	180
90				2,52	1,55	200
100				2,52	1,55	200
110				2,52	1,55	220
120				2,52	1,55	220
130				2,52	1,55	240
140				2,52	1,55	240
150				2,52	1,55	260
160				2,52	1,55	260
170				2,52	1,55	280
180				2,52	1,55	280
190				2,52	1,55	300
200				2,52	1,55	300
210				2,52	1,55	320
220				2,52	1,55	320
230				2,52	1,55	340
240				2,52	1,55	340
260				2,52	1,55	360
280				2,52	1,55	380
300				2,52	1,55	400

Calculated according to EN 1995-1-1, with non-pre-drilled holes and wood density  $\rho_k = 350 \text{ kg/m}^3$ .  $F_{ax,k}$  is limited by head pull-through resistance. Design values  $F_{Rd}$  calculated considering  $k_{mod} = 0,8$  and  $\gamma_M = 1,3$ . Component B thickness is such that:  $B \geq L - A$ . L is the minimum screw length for achieving the respective load-carrying capacity.

**Please note:** these are planning aids. Projects must be calculated only by authorized persons.

## PANELTWISTEC A2 / A4 COUNTERSUNK HEAD – TIMBER-TIMBER

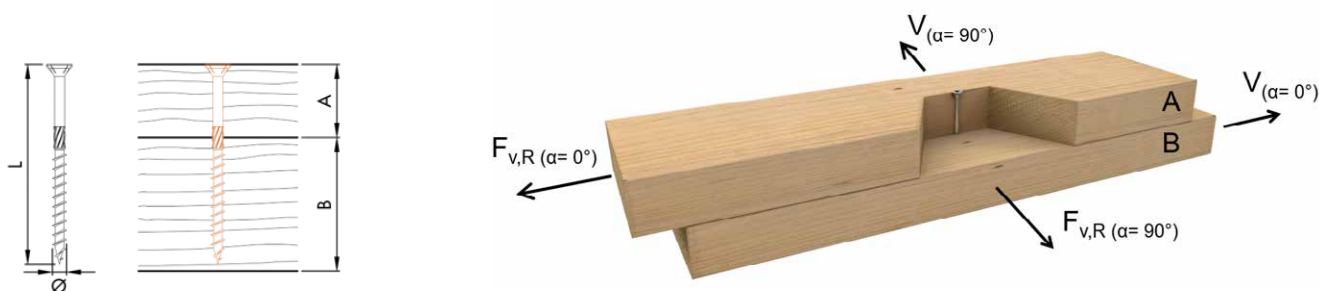

Lateral load-carrying capacity of screws with minimum required lengths.

A [mm]	Ø 6 mm			Ø 8 mm			Ø 6 mm			Ø 8 mm		
	$\alpha_A = 0^\circ$ $\alpha_B = 0^\circ$						$\alpha_A = 90^\circ$ $\alpha_B = 90^\circ$					
	$F_{v,Rk}$ [kN]	$F_{v,Rd}$ [kN]	L [mm]	$F_{v,Rk}$ [kN]	$F_{v,Rd}$ [kN]	L [mm]	$F_{v,Rk}$ [kN]	$F_{v,Rd}$ [kN]	L [mm]	$F_{v,Rk}$ [kN]	$F_{v,Rd}$ [kN]	L [mm]
24	1,48	0,91	60				1,48	0,91	60			
28	1,48	0,91	70				1,48	0,91	70			
30	1,48	0,91	80	3,08	1,90	80	1,48	0,91	80	2,49	1,53	80
32	1,48	0,91	80	3,08	1,90	80	1,48	0,91	80	2,57	1,58	80
36	1,48	0,91	100	3,08	1,90	100	1,48	0,91	100	2,57	1,58	100
40	1,48	0,91	100	3,08	1,90	100	1,48	0,91	100	2,57	1,58	100
45	1,48	0,91	120	3,08	1,90	120	1,48	0,91	120	2,57	1,58	120
50	1,48	0,91	120	3,08	1,90	140	1,48	0,91	120	2,57	1,58	140
60				3,08	1,90	160				2,57	1,58	160
70				3,08	1,90	180				2,57	1,58	180
80				3,08	1,90	180				2,57	1,58	180
90				3,08	1,90	200				2,57	1,58	200
100				3,08	1,90	200				2,57	1,58	200
110				3,08	1,90	220				2,57	1,58	220
120				3,08	1,90	220				2,57	1,58	220
130				3,08	1,90	240				2,57	1,58	240
140				3,08	1,90	240				2,57	1,58	240
150				3,08	1,90	260				2,57	1,58	260
160				3,08	1,90	260				2,57	1,58	260
170				3,08	1,90	280				2,57	1,58	280
180				3,08	1,90	280				2,57	1,58	280
190				3,08	1,90	300				2,57	1,58	300
200				3,08	1,90	300				2,57	1,58	300
210				3,08	1,90	320				2,57	1,58	320
220				3,08	1,90	320				2,57	1,58	320
230				3,08	1,90	340				2,57	1,58	340
240				3,08	1,90	340				2,57	1,58	340
260				3,08	1,90	360				2,57	1,58	360
280				3,08	1,90	380				2,57	1,58	380
300				3,08	1,90	400				2,57	1,58	400

Calculated according to EN 1995-1-1, with non-pre-drilled holes and wood density  $\rho_k = 350 \text{ kg/m}^3$ .  $F_{ax,k}$  is limited by head pull-through resistance. Design values  $F_{v,d}$  calculated considering  $k_{mod} = 0,8$  and  $\gamma_M = 1,3$ . Component B thickness is such that:  $B \geq L - A$ . L is the minimum screw length for achieving the respective load-carrying capacity. **Please note:** These are planning aids. Projects must be calculated only by authorized persons.

## PANELTWISTEC A2 / A4 COUNTERSUNK HEAD – TIMBER-TIMBER

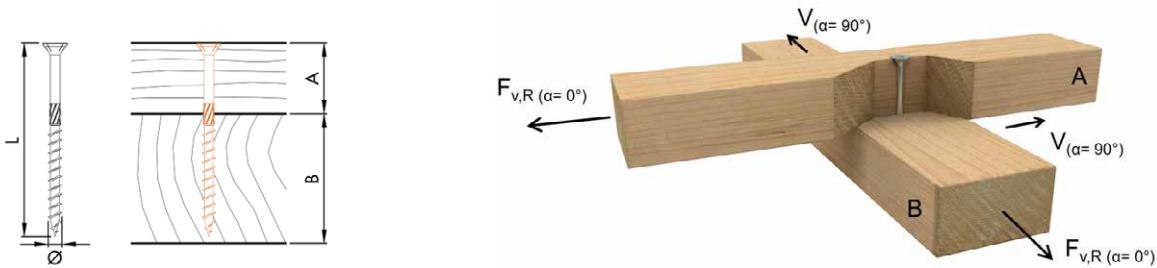

Lateral load-carrying capacity of screws with minimum required lengths.

A [mm]	Ø 6 mm			Ø 8 mm			Ø 6 mm			Ø 8 mm		
	$\alpha_A = 0^\circ$ $\alpha_B = 90^\circ$						$\alpha_A = 90^\circ$ $\alpha_B = 0^\circ$					
	$F_{v,Rk}$ [kN]	$F_{v,Rd}$ [kN]	L [mm]	$F_{v,Rk}$ [kN]	$F_{v,Rd}$ [kN]	L [mm]	$F_{v,Rk}$ [kN]	$F_{v,Rd}$ [kN]	L [mm]	$F_{v,Rk}$ [kN]	$F_{v,Rd}$ [kN]	L [mm]
24	1,48	0,91	60				1,48	0,91	60			
28	1,48	0,91	70				1,48	0,91	70			
30	1,48	0,91	80	2,83	1,74	80	1,48	0,91	80	2,62	1,61	80
32	1,48	0,91	80	2,83	1,74	80	1,48	0,91	80	2,70	1,66	80
36	1,48	0,91	100	2,83	1,74	100	1,48	0,91	100	2,70	1,66	100
40	1,48	0,91	100	2,83	1,74	100	1,48	0,91	100	2,70	1,66	100
45	1,48	0,91	120	2,83	1,74	120	1,48	0,91	120	2,70	1,66	120
50	1,48	0,91	120	2,83	1,74	140	1,48	0,91	120	2,70	1,66	140
60				2,83	1,74	160				2,70	1,66	160
70				2,83	1,74	180				2,70	1,66	180
80				2,83	1,74	180				2,70	1,66	180
90				2,83	1,74	200				2,70	1,66	200
100				2,83	1,74	200				2,70	1,66	200
110				2,83	1,74	220				2,70	1,66	220
120				2,83	1,74	220				2,70	1,66	220
130				2,83	1,74	240				2,70	1,66	240
140				2,83	1,74	240				2,70	1,66	240
150				2,83	1,74	260				2,70	1,66	260
160				2,83	1,74	260				2,70	1,66	260
170				2,83	1,74	280				2,70	1,66	280
180				2,83	1,74	280				2,70	1,66	280
190				2,83	1,74	300				2,70	1,66	300
200				2,83	1,74	300				2,70	1,66	300
210				2,83	1,74	320				2,70	1,66	320
220				2,83	1,74	320				2,70	1,66	320
230				2,83	1,74	340				2,70	1,66	340
240				2,83	1,74	340				2,70	1,66	340
260				2,83	1,74	360				2,70	1,66	360
280				2,83	1,74	380				2,70	1,66	380
300				2,83	1,74	400				2,70	1,66	400

Calculated according to EN 1995-1-1, with non-pre-drilled holes and wood density  $\rho_k = 350 \text{ kg/m}^3$ .  $F_{ax,k}$  is limited by head pull-through resistance. Design values  $F_{Rd}$  calculated considering  $k_{mod} = 0,8$  and  $\gamma_M = 1,3$ . Component B thickness is such that:  $B \geq L - A$ . L is the minimum screw length for achieving the respective load-carrying capacity. **Please note:** These are planning aids. Projects must be calculated only by authorized persons.

## PANELTWISTEC A2 / A4 COUNTERSUNK HEAD – STEEL-TIMBER, THIN PLATE

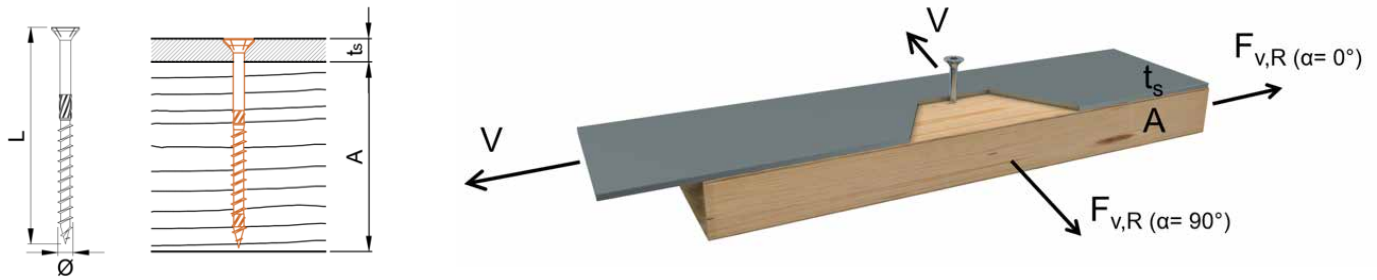

Lateral load-carrying capacity of screws with minimum required lengths.

A [mm]	Ø 6 mm ts = 3 mm			Ø 8 mm ts = 4 mm			Ø 6 mm ts = 3 mm			Ø 8 mm ts = 4 mm		
	$\alpha_A = 0^\circ$						$\alpha_A = 90^\circ$					
	F <sub>v,Rk</sub> [kN]	F <sub>v,Rd</sub> [kN]	L [mm]	F <sub>v,Rk</sub> [kN]	F <sub>v,Rd</sub> [kN]	L [mm]	F <sub>v,Rk</sub> [kN]	F <sub>v,Rd</sub> [kN]	L [mm]	F <sub>v,Rk</sub> [kN]	F <sub>v,Rd</sub> [kN]	L [mm]
60	1,77	1,09	60				1,77	1,09	60			
70	1,87	1,15	70				1,87	1,15	70			
80	1,97	1,21	80	3,51	2,16	80	1,97	1,21	80	3,08	1,9	80
90	1,97	1,21	80	3,51	2,16	80	1,97	1,21	80	3,08	1,9	80
100	2,18	1,34	100	3,78	2,33	100	2,18	1,34	100	3,35	2,06	100
110	2,18	1,34	100	3,78	2,33	100	2,18	1,34	100	3,35	2,06	100
120	2,18	1,34	120	4,22	2,6	120	2,18	1,34	120	3,79	2,33	120
130	2,18	1,34	120	4,22	2,6	120	2,18	1,34	120	3,79	2,33	120
140				4,22	2,6	140				3,79	2,33	140
150				4,22	2,6	140				3,79	2,33	140
160				4,22	2,6	160				3,79	2,33	160
180				4,22	2,6	180				3,79	2,33	180
200				4,22	2,6	200				3,79	2,33	200
220				4,22	2,6	220				3,79	2,33	220
240				4,22	2,6	240				3,79	2,33	240
260				4,22	2,6	260				3,79	2,33	260
280				4,22	2,6	280				3,79	2,33	280
300				4,22	2,6	300				3,79	2,33	300
320				4,22	2,6	320				3,79	2,33	320
340				4,22	2,6	340				3,79	2,33	340
360				4,22	2,6	360				3,79	2,33	360
380				4,22	2,6	380				3,79	2,33	380
400				4,22	2,6	400				3,79	2,33	400

Calculated according to EN 1995-1-1, with non-predrilled holes and wood density  $\rho_k = 350 \text{ kg/m}^3$ . Design values  $F_{v,Rd}$  calculated considering  $k_{mod} = 0,8$  and  $\gamma_M = 1,3$ . L is the minimum screw length for achieving the respective load-carrying capacity.

Please note: These are planning aids. Projects must be calculated only by authorized persons.

## PANELTWISTEC A2 / A4 COUNTERSUNK HEAD – STEEL-TIMBER, THICK PLATE

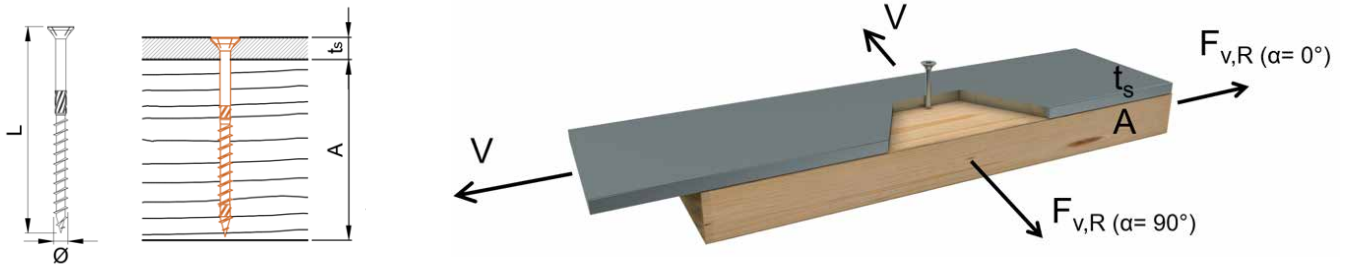

Lateral load-carrying capacity of screws with minimum required lengths.

A [mm]	Ø 6 mm 6 mm ≤ ts ≤ 9 mm			Ø 8 mm 8 mm ≤ ts ≤ 12 mm			Ø 6 mm 6 mm ≤ ts ≤ 9 mm			Ø 8 mm 8 mm ≤ ts ≤ 12 mm		
	α <sub>A</sub> = 0°						α <sub>A</sub> = 90°					
	F <sub>v,Rk</sub> [kN]	F <sub>v,Rd</sub> [kN]	L [mm]	F <sub>v,Rk</sub> [kN]	F <sub>v,Rd</sub> [kN]	L [mm]	F <sub>v,Rk</sub> [kN]	F <sub>v,Rd</sub> [kN]	L [mm]	F <sub>v,Rk</sub> [kN]	F <sub>v,Rd</sub> [kN]	L [mm]
60	2,25	1,38	60				2,25	1,38	60			
70	2,35	1,45	70				2,35	1,45	70			
80	2,45	2,51	80	4,52	2,78	80	2,45	2,51	80	3,92	2,41	80
90	2,45	2,51	80	4,52	2,78	80	2,45	2,51	80	3,92	2,41	80
100	2,66	2,64	100	4,79	2,95	100	2,66	2,64	100	4,18	2,57	100
110	2,66	2,64	100	4,79	2,95	100	2,66	2,64	100	4,18	2,57	100
120	2,66	2,64	120	5,23	3,22	120	2,66	2,64	120	4,63	2,85	120
130	2,66	2,64	120	5,23	3,22	120	2,66	2,64	120	4,63	2,85	120
140				5,23	3,22	140				4,63	2,85	140
150				5,23	3,22	140				4,63	2,85	140
160				5,23	3,22	160				4,63	2,85	160
180				5,23	3,22	180				4,63	2,85	180
200				5,23	3,22	200				4,63	2,85	200
220				5,23	3,22	220				4,63	2,85	220
240				5,23	3,22	240				4,63	2,85	240
260				5,23	3,22	260				4,63	2,85	260
280				5,23	3,22	280				4,63	2,85	280
300				5,23	3,22	300				4,63	2,85	300
320				5,23	3,22	320				4,63	2,85	320
340				5,23	3,22	340				4,63	2,85	340
360				5,23	3,22	360				4,63	2,85	360
380				5,23	3,22	380				4,63	2,85	380
400				5,23	3,22	400				4,63	2,85	400

Calculated according to EN 1995-1-1, with non-predrilled holes and wood density  $\rho_k = 350 \text{ kg/m}^3$ . Design values  $F_{v,Rd}$  calculated considering  $k_{mod} = 0,8$  and  $\gamma_M = 1,3$ . L is the minimum screw length for achieving the respective load-carrying capacity.

**Please note:** These are planning aids. Projects must be calculated only by authorized persons.

## PANELTWISTEC A2 / A4 WASHER HEAD – TIMBER-TIMBER



Axial load-carrying capacity of screws with minimum required lengths.

A [mm]	Ø 8 mm		
	$F_{ax,Rk}$ [kN]	$F_{ax,Rd}$ [kN]	L [mm]
30	3,07	1,89	80
32	3,07	1,89	80
36	3,07	1,89	100
40	3,07	1,89	100
45	3,07	1,89	120
50	3,07	1,89	140
60	3,07	1,89	160
70	3,07	1,89	180
80	3,07	1,89	180
90	3,07	1,89	200
100	3,07	1,89	200
110	3,07	1,89	220
120	3,07	1,89	220
130	3,07	1,89	240
140	3,07	1,89	240
150	3,07	1,89	260
160	3,07	1,89	260
170	3,07	1,89	280
180	3,07	1,89	280
190	3,07	1,89	300
200	3,07	1,89	300
210	3,07	1,89	320
220	3,07	1,89	320
230	3,07	1,89	340
240	3,07	1,89	340
260	3,07	1,89	360
280	3,07	1,89	380
300	3,07	1,89	400

Calculated according to EN 1995-1-1, with non-predrilled holes and wood density  $\rho_k = 350 \text{ kg/m}^3$ .  $F_{ax,k}$  is limited by head pull-through resistance. Design values  $F_{Rd}$  calculated considering  $k_{mod} = 0,8$  and  $\gamma_M = 1,3$ . Component B thickness is such that:  $B \geq L - A$ . L is the minimum screw length for achieving the respective load-carrying capacity.

**Please note:** These are planning aids. Projects must be calculated only by authorized persons.



## PANELTWISTEC A2 / A4 WASHER HEAD – TIMBER-TIMBER

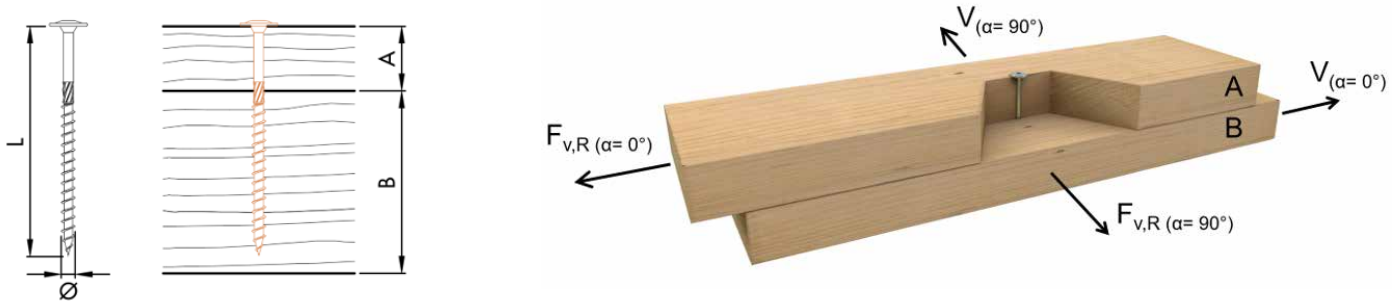

Lateral load-carrying capacity of screws with minimum required lengths.

Ø 8 mm						
$\alpha_A = 0^\circ; \alpha_B = 0^\circ$ $\alpha_A = 90^\circ; \alpha_B = 90^\circ$						
A [mm]	$F_{v,Rk}$ [kN]	$F_{v,Rd}$ [kN]	L [mm]	$F_{v,Rk}$ [kN]	$F_{v,Rd}$ [kN]	L [mm]
30	3,21	1,98	80	2,63	1,62	80
32	3,21	1,98	80	2,63	1,62	80
36	3,21	1,98	100	2,63	1,62	100
40	3,21	1,98	100	2,63	1,62	100
45	3,21	1,98	120	2,63	1,62	120
50	3,21	1,98	140	2,63	1,62	140
60	3,21	1,98	160	2,63	1,62	160
70	3,21	1,98	180	2,63	1,62	180
80	3,21	1,98	180	2,63	1,62	180
90	3,21	1,98	200	2,63	1,62	200
100	3,21	1,98	200	2,63	1,62	200
110	3,21	1,98	220	2,63	1,62	220
120	3,21	1,98	220	2,63	1,62	220
130	3,21	1,98	240	2,63	1,62	240
140	3,21	1,98	240	2,63	1,62	240
150	3,21	1,98	260	2,63	1,62	260
160	3,21	1,98	260	2,63	1,62	260
170	3,21	1,98	280	2,63	1,62	280
180	3,21	1,98	280	2,63	1,62	280
190	3,21	1,98	300	2,63	1,62	300
200	3,21	1,98	300	2,63	1,62	300
210	3,21	1,98	320	2,63	1,62	320
220	3,21	1,98	320	2,63	1,62	320
230	3,21	1,98	340	2,63	1,62	340
240	3,21	1,98	340	2,63	1,62	340
260	3,21	1,98	360	2,63	1,62	360
280	3,21	1,98	380	2,63	1,62	380
300	3,21	1,98	400	2,63	1,62	400

Calculated according to EN 1995-1-1, with non-predrilled holes and wood density  $\rho_k = 350 \text{ kg/m}^3$ .  $F_{ax,k}$  is limited by head pull-through resistance. Design values  $F_{Rd}$  calculated considering  $k_{mod} = 0,8$  and  $\gamma_M = 1,3$ . Component B thickness is such that:  $B \geq L - A$ . L is the minimum screw length for achieving the respective load-carrying capacity.

**Please note:** These are planning aids. Projects must be calculated only by authorized persons.

## PANELTWISTEC A2 / A4 WASHER HEAD – TIMBER-TIMBER

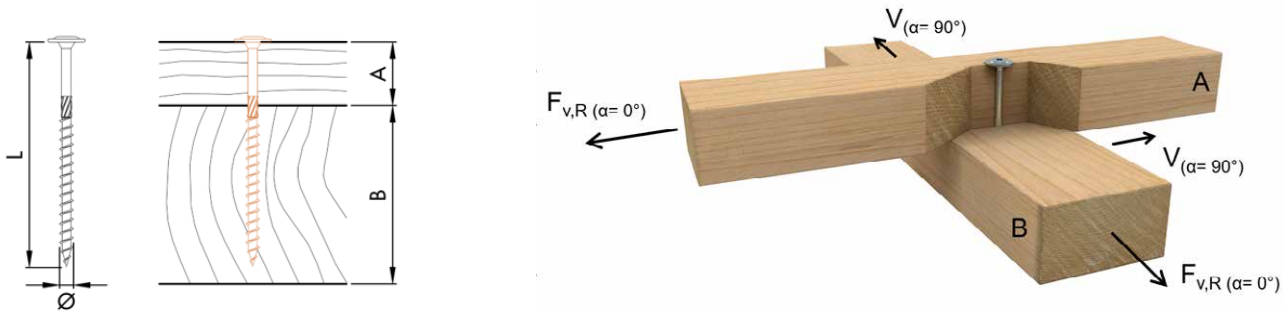

Lateral load-carrying capacity of screws with minimum required lengths.

		Ø 8 mm					
		$\alpha_A = 0^\circ; \alpha_B = 90^\circ$			$\alpha_A = 90^\circ; \alpha_B = 0^\circ$		
A [mm]	$F_{v,Rk}$ [kN]	$F_{v,Rd}$ [kN]	L [mm]	$F_{v,Rk}$ [kN]	$F_{v,Rd}$ [kN]	L [mm]	
30	2,97	1,83	80	2,75	1,69	80	
32	2,97	1,83	80	2,75	1,69	80	
36	2,97	1,83	100	2,75	1,69	100	
40	2,97	1,83	100	2,75	1,69	100	
45	2,97	1,83	120	2,75	1,69	120	
50	2,97	1,83	140	2,75	1,69	140	
60	2,97	1,83	160	2,75	1,69	160	
70	2,97	1,83	180	2,75	1,69	180	
80	2,97	1,83	180	2,75	1,69	180	
90	2,97	1,83	200	2,75	1,69	200	
100	2,97	1,83	200	2,75	1,69	200	
110	2,97	1,83	220	2,75	1,69	220	
120	2,97	1,83	220	2,75	1,69	220	
130	2,97	1,83	240	2,75	1,69	240	
140	2,97	1,83	240	2,75	1,69	240	
150	2,97	1,83	260	2,75	1,69	260	
160	2,97	1,83	260	2,75	1,69	260	
170	2,97	1,83	280	2,75	1,69	280	
180	2,97	1,83	280	2,75	1,69	280	
190	2,97	1,83	300	2,75	1,69	300	
200	2,97	1,83	300	2,75	1,69	300	
210	2,97	1,83	320	2,75	1,69	320	
220	2,97	1,83	320	2,75	1,69	320	
230	2,97	1,83	340	2,75	1,69	340	
240	2,97	1,83	340	2,75	1,69	340	
260	2,97	1,83	360	2,75	1,69	360	
280	2,97	1,83	380	2,75	1,69	380	
300	2,97	1,83	400	2,75	1,69	400	

Calculated according to EN 1995-1-1, with non-pre-drilled holes and wood density  $\rho_k = 350 \text{ kg/m}^3$ .  $F_{ax,k}$  is limited by head pull-through resistance. Design values  $F_{Rd}$  calculated considering  $k_{mod} = 0,8$  and  $\gamma_M = 1,3$ . Component B thickness is such that:  $B \geq L - A$ . L is the minimum screw length for achieving the respective load-carrying capacity.

**Please note:** These are planning aids. Projects must be calculated only by authorized persons.

# SAWTEC

Wood construction screw made of hardened carbon steel



The SawTec is a wood construction screw **with a special screw tip and saw teeth below the head**. The screw has a **double-stage cylinder head**. The special geometry of the screw tip **reduces the screwing torque** and also leads to a **lower splitting effect** when screwing in.

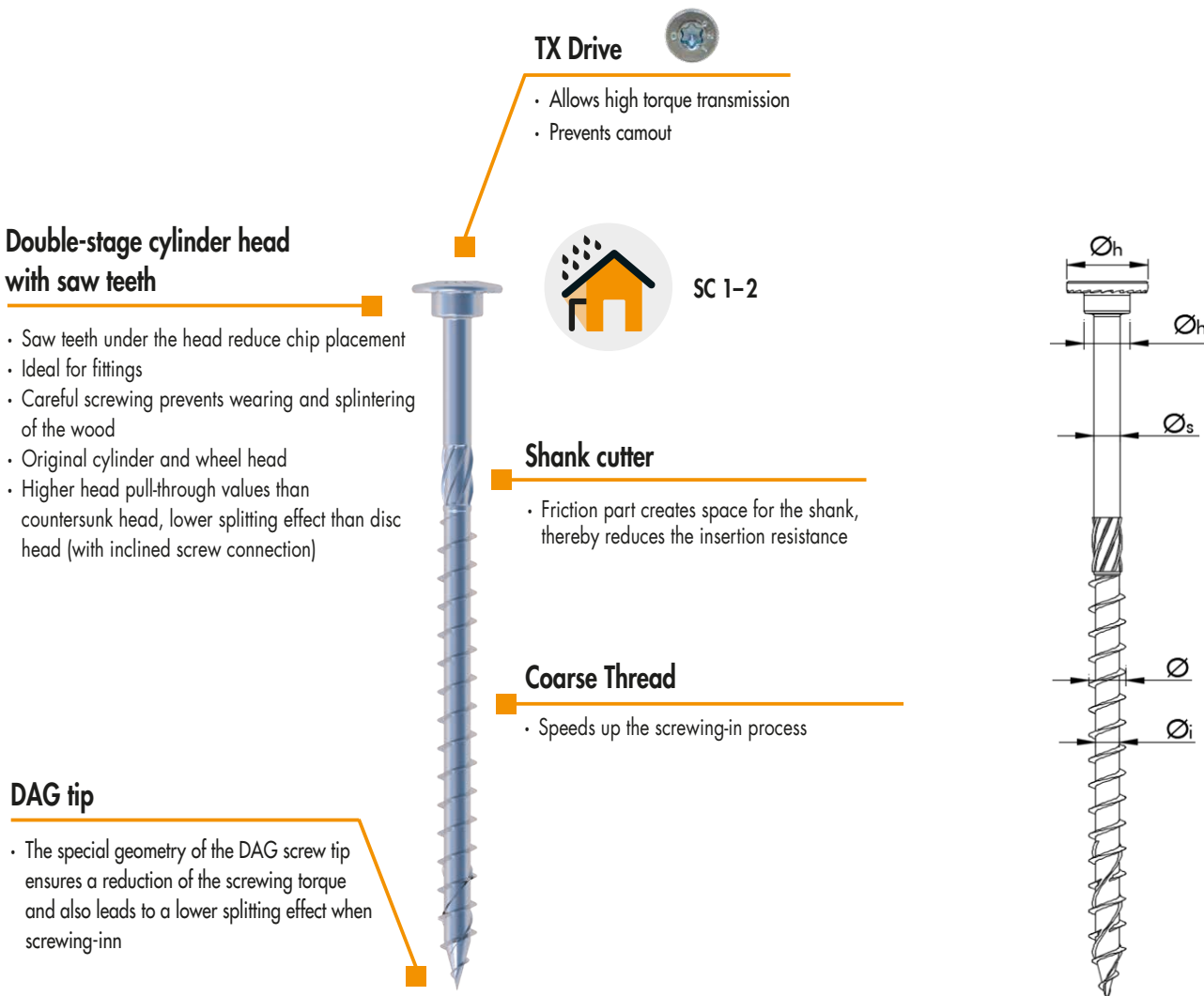

Sawtec									
Geometric properties						Mechanical properties			
Nominal Ø [mm]	Inner Ø <sub>i</sub> [mm]	Shaft Ø <sub>s</sub> [mm]	Head Ø <sub>h</sub> [mm]	Head Ø <sub>hi</sub> [mm]	Thread length with tip [mm]	f <sub>tens,k</sub> [kN]	f <sub>ax,k</sub> [MPa]	f <sub>head,k</sub> [MPa]	M <sub>y,k</sub> [Nm]
6	4,0	4,4	13,0	6,5	24–70	11,0	11,4	10,0	9,5
8	5,3	5,8	18,0	10,3	32–100	20,0	11,1	10,0	20,0
10	6,3	7,1	22,0	11,0	40–100	28,0	10,8	10,0	35,8

# MINIMUM DISTANCES FOR SHEAR LOADS

Sawtec

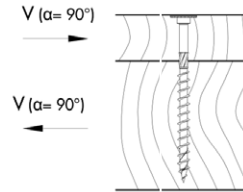
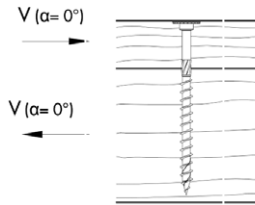

Ø [mm]	Predrilled holes				Predrilled holes			
	Rules	6	8	10	Rules	6	8	10
a <sub>1</sub>	5 · d	30	40	50	4 · d	24	32	40
a <sub>2</sub>	3 · d	18	24	30	4 · d	24	32	40
a <sub>3,c</sub>	7 · d	42	56	70	7 · d	42	56	70
a <sub>3,t</sub>	12 · d	72	96	120	7 · d	42	56	70
a <sub>4,c</sub>	3 · d	18	24	30	3 · d	18	24	30
a <sub>4,t</sub>	3 · d	18	24	30	7 · d	42	56	70

Ø [mm]	Non-predrilled holes				Non-predrilled holes			
	Rules	6	8	10	Rules	6	8	10
a <sub>1</sub>	12 · d	72	96	120	5 · d	30	40	50
a <sub>2</sub>	5 · d	30	40	50	5 · d	30	40	50
a <sub>3,c</sub>	10 · d	60	80	100	10 · d	60	80	100
a <sub>3,t</sub>	15 · d	90	120	150	10 · d	60	80	100
a <sub>4,c</sub>	5 · d	30	40	50	5 · d	30	40	50
a <sub>4,t</sub>	5 · d	30	40	50	10 · d	60	80	100

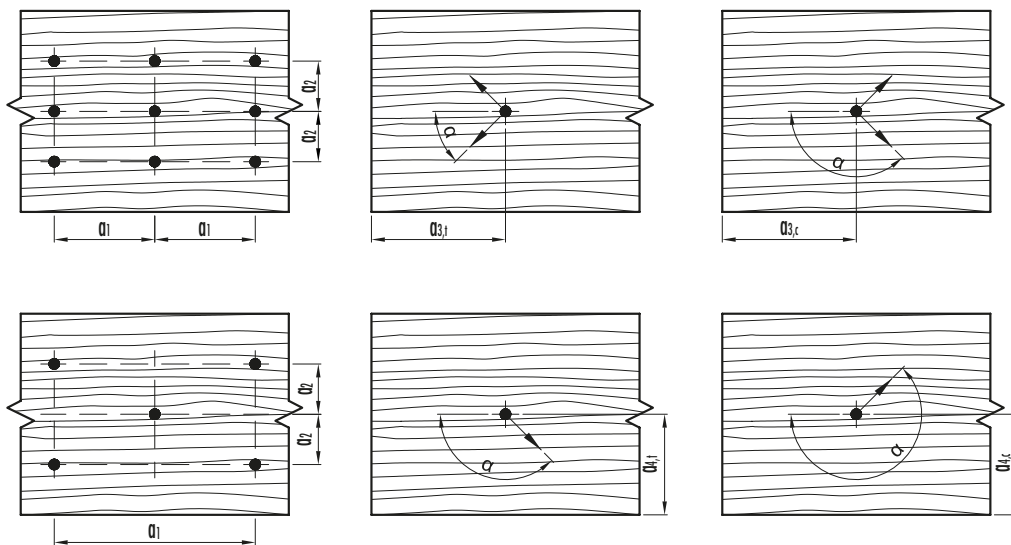

**Notes:** The minimum distances for axially-loaded screws are in accordance with ETA-11/0024 considering a softwood density of  $\rho_k \leq 420 \text{ kg/m}^3$ , where  $d$  = nominal screw diameter, minimum wood thickness,  $t = 10 \cdot d$  and minimum width,  $w = \max [8 \cdot d; 60 \text{ mm}]$ . For steel-to-timber joints, the axial spacings  $a_1$  and  $a_2$  can be reduced by a factor of 0,7. In wood members of Douglas fir, the minimum distances must be increased by 1,5. The edge distances and spacings of each timber member must be checked independently according to load and grain direction.

## SAWTEC – TIMBER-TIMBER



Axial load-carrying capacity of screws with minimum required lengths.

A [mm]	Ø 6 mm			Ø 8 mm			Ø 10 mm		
	$F_{ax,Rk}$ [kN]	$F_{ax,Rd}$ [kN]	L [mm]	$F_{ax,Rk}$ [kN]	$F_{ax,Rd}$ [kN]	L [mm]	$F_{ax,Rk}$ [kN]	$F_{ax,Rd}$ [kN]	L [mm]
24	1,69	1,04	60						
28	1,69	1,04	70						
30	1,69	1,04	80	3,24	1,99	80			
32	1,69	1,04	80	3,24	1,99	100			
36	1,69	1,04	100	3,24	1,99	100			
40	1,69	1,04	100	3,24	1,99	100	4,84	2,98	100
45	1,69	1,04	120	3,24	1,99	120	4,84	2,98	120
50	1,69	1,04	120	3,24	1,99	140	4,84	2,98	140
60	1,69	1,04	140	3,24	1,99	160	4,84	2,98	160
65	1,69	1,04	140	3,24	1,99	180	4,84	2,98	180
70	1,69	1,04	140	3,24	1,99	180	4,84	2,98	180
80	1,69	1,04	160	3,24	1,99	180	4,84	2,98	180
90	1,69	1,04	160	3,24	1,99	200	4,84	2,98	200
100	1,69	1,04	180	3,24	1,99	200	4,84	2,98	200
110	1,69	1,04	180	3,24	1,99	220	4,84	2,98	220
120				3,24	1,99	220	4,84	2,98	220
140				3,24	1,99	240	4,84	2,98	240
160				3,24	1,99	260	4,84	2,98	260
180				3,24	1,99	280	4,84	2,98	280
200				3,24	1,99	300	4,84	2,98	300
220				3,24	1,99	320	4,84	2,98	320
240				3,24	1,99	340	4,84	2,98	340
260				3,24	1,99	360	4,84	2,98	360
280				3,24	1,99	380	4,84	2,98	380
300				3,24	1,99	400	4,84	2,98	400
300				3,24	1,99	420			
300				3,24	1,99	440			
300				3,24	1,99	460			
300				3,24	1,99	480			
300				3,24	1,99	500			
300				3,24	1,99	550			
300				3,24	1,99	600			

Calculated according to EN 1995-1-1, with non-pre-drilled holes and wood density  $\rho_k = 350 \text{ kg/m}^3$ .  $F_{ax,k}$  is limited by head pull-through resistance. Design values  $F_{Rd}$  calculated considering  $k_{mod} = 0,8$  and  $\gamma_M = 1,3$ . Component B thickness is such that:  $B \geq L - A$ . L is the minimum screw length for achieving the respective load-carrying capacity.

**Please note:** these are planning aids. Projects must be calculated only by authorized persons.

## SAWTEC – TIMBER-TIMBER

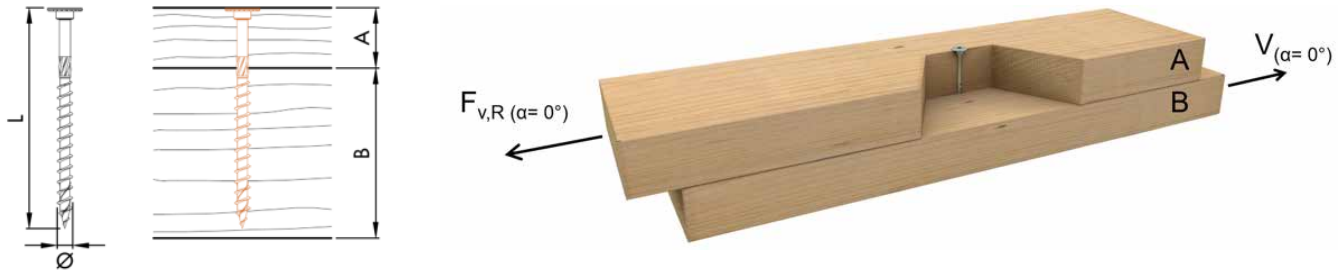

Lateral load-carrying capacity of screws with minimum required lengths.

	Ø 6 mm			Ø 8 mm			Ø 10 mm		
	$\alpha_A = 0^\circ$ $\alpha_B = 0^\circ$								
A [mm]	$F_{v,Rk}$ [kN]	$F_{v,Rd}$ [kN]	L [mm]	$F_{v,Rk}$ [kN]	$F_{v,Rd}$ [kN]	L [mm]	$F_{v,Rk}$ [kN]	$F_{v,Rd}$ [kN]	L [mm]
24	1,64	1,01	60						
28	1,74	1,07	70						
30	1,79	1,10	80	3,68	2,26	80			
32	1,84	1,13	80	3,79	2,33	100			
36	2,01	1,24	100	4,03	2,48	100			
40	2,01	1,24	100	4,15	2,55	100	5,71	3,51	100
45	2,01	1,24	120	4,15	2,55	120	6,08	3,74	120
50	2,01	1,24	120	4,15	2,55	140	6,16	3,79	140
60	2,01	1,24	140	4,15	2,55	160	6,16	3,79	160
65	2,01	1,24	140	4,15	2,55	180	6,16	3,79	180
70	2,01	1,24	140	4,15	2,55	180	6,16	3,79	180
80	2,01	1,24	160	4,15	2,55	180	6,16	3,79	180
90	2,01	1,24	160	4,15	2,55	200	6,16	3,79	200
100	2,01	1,24	180	4,15	2,55	200	6,16	3,79	200
110	2,01	1,24	180	4,15	2,55	220	6,16	3,79	220
120				4,15	2,55	220	6,16	3,79	220
140				4,15	2,55	240	6,16	3,79	240
160				4,15	2,55	260	6,16	3,79	260
180				4,15	2,55	280	6,16	3,79	280
200				4,15	2,55	300	6,16	3,79	300
220				4,15	2,55	320	6,16	3,79	320
240				4,15	2,55	340	6,16	3,79	340
260				4,15	2,55	360	6,16	3,79	360
280				4,15	2,55	380	6,16	3,79	380
300				4,15	2,55	400	6,16	3,79	400
300				4,15	2,55	420			
300				4,15	2,55	440			
300				4,15	2,55	460			
300				4,15	2,55	480			
300				4,15	2,55	500			
300				4,15	2,55	550			
300				4,15	2,55	600			

Calculated according to EN 1995-1-1, with non-pre-drilled holes and wood density  $\rho_k = 350 \text{ kg/m}^3$ . Design values  $F_{v,Rd}$  calculated considering  $k_{mod} = 0,8$  and  $\gamma_{M1} = 1,3$ . Component B thickness is such that:  $B \geq L - A$ . L is the minimum screw length for achieving the respective load-carrying capacity.

**Please note:** these are planning aids. Projects must be calculated only by authorized persons.

## SAWTEC – TIMBER-TIMBER



Lateral load-carrying capacity of screws with minimum required lengths.

A [mm]	Ø 6 mm			Ø 8 mm			Ø 10 mm		
	$F_{v,Rk}$ [kN]	$F_{v,Rd}$ [kN]	L [mm]	$F_{v,Rk}$ [kN]	$F_{v,Rd}$ [kN]	L [mm]	$F_{v,Rk}$ [kN]	$F_{v,Rd}$ [kN]	L [mm]
24	1,64	1,01	60						
28	1,74	1,07	70						
30	1,79	1,10	80	2,95	1,82	80			
32	1,84	1,13	80	3,02	1,86	100			
36	2,01	1,24	100	3,16	1,94	100			
40	2,01	1,24	100	3,32	2,04	100	4,48	2,76	100
45	2,01	1,24	120	3,52	2,17	120	4,70	2,89	120
50	2,01	1,24	120	3,57	2,20	140	4,93	3,03	140
60	2,01	1,24	140	3,57	2,20	160	5,25	3,23	160
65	2,01	1,24	140	3,57	2,20	180	5,25	3,23	180
70	2,01	1,24	140	3,57	2,20	180	5,25	3,23	180
80	2,01	1,24	160	3,57	2,20	180	5,25	3,23	180
90	2,01	1,24	160	3,57	2,20	200	5,25	3,23	200
100	2,01	1,24	180	3,57	2,20	200	5,25	3,23	200
110	2,01	1,24	180	3,57	2,20	220	5,25	3,23	220
120				3,57	2,20	220	5,25	3,23	220
140				3,57	2,20	240	5,25	3,23	240
160				3,57	2,20	260	5,25	3,23	260
180				3,57	2,20	280	5,25	3,23	280
200				3,57	2,20	300	5,25	3,23	300
220				3,57	2,20	320	5,25	3,23	320
240				3,57	2,20	340	5,25	3,23	340
260				3,57	2,20	360	5,25	3,23	360
280				3,57	2,20	380	5,25	3,23	380
300				3,57	2,20	400	5,25	3,23	400
300				3,57	2,20	420			
300				3,57	2,20	440			
300				3,57	2,20	460			
300				3,57	2,20	480			
300				3,57	2,20	500			
300				3,57	2,20	550			
300				3,57	2,20	600			

Calculated according to EN 1995-1-1, with non-predrilled holes and wood density  $\rho_k = 350 \text{ kg/m}^3$ . Design values  $F_{v,Rd}$  calculated considering  $k_{mod} = 0,8$  and  $\gamma_M = 1,3$ . Component B thickness is such that:  $B \geq L - A$ . L is the minimum screw length for achieving the respective load-carrying capacity.

**Please note:** these are planning aids. Projects must be calculated only by authorized persons.

## SAWTEC – TIMBER-TIMBER

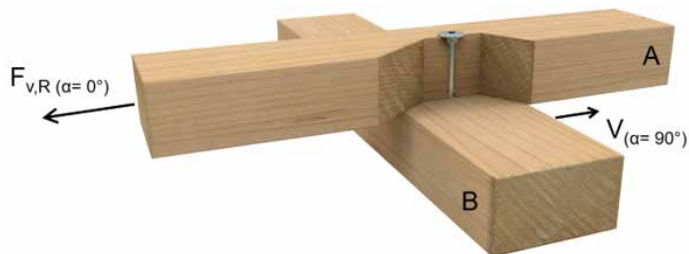
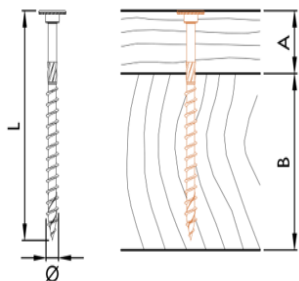

Lateral load-carrying capacity of screws with minimum required lengths.

	Ø 6 mm			Ø 8 mm			Ø 10 mm		
	$F_{v,Rk}$ [kN]	$F_{v,Rd}$ [kN]	L [mm]	$F_{v,Rk}$ [kN]	$F_{v,Rd}$ [kN]	L [mm]	$F_{v,Rk}$ [kN]	$F_{v,Rd}$ [kN]	L [mm]
	$\alpha_A = 0^\circ$ $\alpha_B = 90^\circ$								
A [mm]									
24	1,64	1,01	60						
28	1,74	1,07	70						
30	1,79	1,10	80	3,46	2,13	80			
32	1,84	1,13	80	3,57	2,20	100			
36	2,01	1,24	100	3,79	2,33	100			
40	2,01	1,24	100	3,82	2,35	100	5,35	3,29	100
45	2,01	1,24	120	3,82	2,35	120	5,63	3,46	120
50	2,01	1,24	120	3,82	2,35	140	5,63	3,46	140
60	2,01	1,24	140	3,82	2,35	160	5,63	3,46	160
65	2,01	1,24	140	3,82	2,35	180	5,63	3,46	180
70	2,01	1,24	140	3,82	2,35	180	5,63	3,46	180
80	2,01	1,24	160	3,82	2,35	180	5,63	3,46	180
90	2,01	1,24	160	3,82	2,35	200	5,63	3,46	200
100	2,01	1,24	180	3,82	2,35	200	5,63	3,46	200
110	2,01	1,24	180	3,82	2,35	220	5,63	3,46	220
120				3,82	2,35	220	5,63	3,46	220
140				3,82	2,35	240	5,63	3,46	240
160				3,82	2,35	260	5,63	3,46	260
180				3,82	2,35	280	5,63	3,46	280
200				3,82	2,35	300	5,63	3,46	300
220				3,82	2,35	320	5,63	3,46	320
240				3,82	2,35	340	5,63	3,46	340
260				3,82	2,35	360	5,63	3,46	360
280				3,82	2,35	380	5,63	3,46	380
300				3,82	2,35	400	5,63	3,46	400
300				3,82	2,35	420			
300				3,82	2,35	440			
300				3,82	2,35	460			
300				3,82	2,35	480			
300				3,82	2,35	500			
300				3,82	2,35	550			
300				3,82	2,35	600			

Calculated according to EN 1995-1-1, with non-pre-drilled holes and wood density  $\rho_k = 350 \text{ kg/m}^3$ . Design values  $F_{v,Rd}$  calculated considering  $k_{mod} = 0,8$  and  $\gamma_{M1} = 1,3$ . Component B thickness is such that:  $B \geq L - A$ . L is the minimum screw length for achieving the respective load-carrying capacity. **Please note:** these are planning aids. Projects must be calculated only by authorized persons.



## SAWTEC – TIMBER-TIMBER

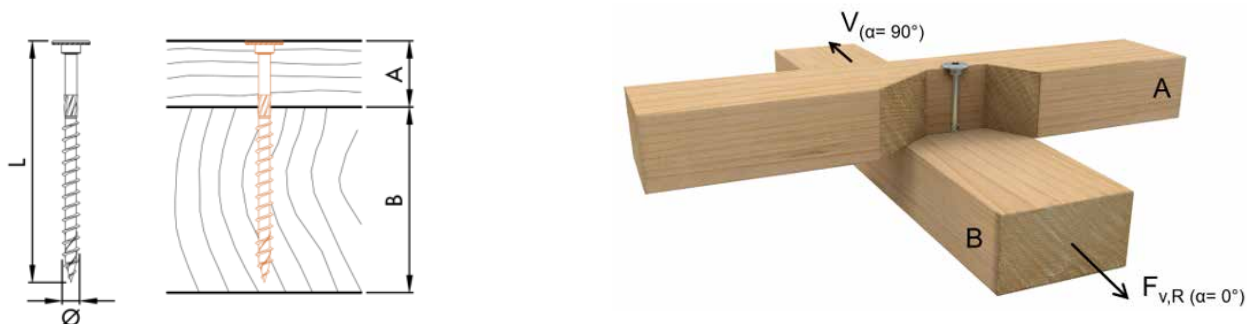

Lateral load-carrying capacity of screws with minimum required lengths.

A [mm]	Ø 6 mm			Ø 8 mm			Ø 10 mm		
	$F_{v,Rk}$ [kN]	$F_{v,Rd}$ [kN]	L [mm]	$F_{v,Rk}$ [kN]	$F_{v,Rd}$ [kN]	L [mm]	$F_{v,Rk}$ [kN]	$F_{v,Rd}$ [kN]	L [mm]
24	1,64	1,01	60						
28	1,74	1,07	70						
30	1,79	1,10	80	3,10	1,91	80			
32	1,84	1,13	80	3,17	1,95	100			
36	2,01	1,24	100	3,32	2,04	100			
40	2,01	1,24	100	3,48	2,14	100	4,72	2,90	100
45	2,01	1,24	120	3,69	2,27	120	4,95	3,05	120
50	2,01	1,24	120	3,82	2,35	140	5,19	3,19	140
60	2,01	1,24	140	3,82	2,35	160	5,63	3,46	160
65	2,01	1,24	140	3,82	2,35	180	5,63	3,46	180
70	2,01	1,24	140	3,82	2,35	180	5,63	3,46	180
80	2,01	1,24	160	3,82	2,35	180	5,63	3,46	180
90	2,01	1,24	160	3,82	2,35	200	5,63	3,46	200
100	2,01	1,24	180	3,82	2,35	200	5,63	3,46	200
110	2,01	1,24	180	3,82	2,35	220	5,63	3,46	220
120				3,82	2,35	220	5,63	3,46	220
140				3,82	2,35	240	5,63	3,46	240
160				3,82	2,35	260	5,63	3,46	260
180				3,82	2,35	280	5,63	3,46	280
200				3,82	2,35	300	5,63	3,46	300
220				3,82	2,35	320	5,63	3,46	320
240				3,82	2,35	340	5,63	3,46	340
260				3,82	2,35	360	5,63	3,46	360
280				3,82	2,35	380	5,63	3,46	380
300				3,82	2,35	400	5,63	3,46	400
300				3,82	2,35	420			
300				3,82	2,35	440			
300				3,82	2,35	460			
300				3,82	2,35	480			
300				3,82	2,35	500			
300				3,82	2,35	550			
300				3,82	2,35	600			

Calculated according to EN 1995-1-1, with non-pre-drilled holes and wood density  $\rho_k = 350 \text{ kg/m}^3$ . Design values  $F_{v,Rd}$  calculated considering  $k_{mod} = 0,8$  and  $\gamma_M = 1,3$ . Component B thickness is such that:  $B \geq L - A$ . L is the minimum screw length for achieving the respective load-carrying capacity. **Please note:** these are planning aids. Projects must be calculated only by authorized persons.

## SAWTEC – STEEL-TIMBER, THIN PLATE

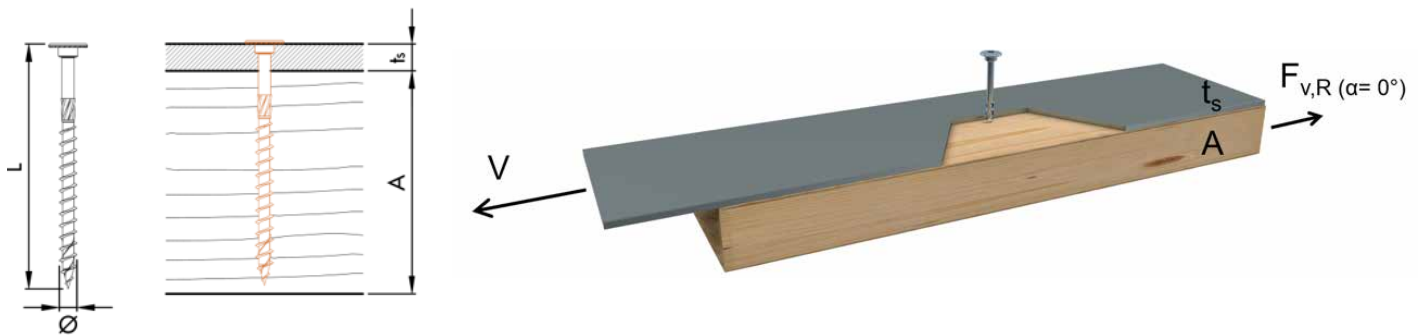

Lateral load-carrying capacity of screws with minimum required lengths.

A [mm]	Ø 6 mm $t_s \leq 3$ mm			Ø 8 mm $t_s \leq 4$ mm			Ø 10 mm $t_s \leq 5$ mm		
	$\alpha_A = 0^\circ$								
	$F_{v,Rk}$ [kN]	$F_{v,Rd}$ [kN]	L [mm]	$F_{v,Rk}$ [kN]	$F_{v,Rd}$ [kN]	L [mm]	$F_{v,Rk}$ [kN]	$F_{v,Rd}$ [kN]	L [mm]
60	2,21	1,36	60						
70	2,31	1,42	70						
80	2,41	1,48	80	4,45	2,74	80			
90	2,41	1,48	80	4,45	2,74	80			
100	2,62	1,61	100	4,67	2,87	100	6,57	4,04	100
110	2,62	1,61	100	4,67	2,87	100	6,57	4,04	100
120	2,79	1,72	120	4,90	3,02	120	6,84	4,21	120
140	2,79	1,72	140	5,12	3,15	140	7,11	4,38	140
150	2,79	1,72	140	5,12	3,15	140	7,11	4,38	140
160	2,79	1,72	160	5,56	3,42	160	7,38	4,54	160
180	2,79	1,72	180	5,56	3,42	180	7,65	4,71	180
200				5,56	3,42	200	7,65	4,71	200
220				5,56	3,42	220	7,65	4,71	220
240				5,56	3,42	240	7,65	4,71	240
260				5,56	3,42	260	7,65	4,71	260
280				5,56	3,42	280	7,65	4,71	280
300				5,56	3,42	300	7,65	4,71	300
320				5,56	3,42	320	7,65	4,71	320
340				5,56	3,42	340	7,65	4,71	340
360				5,56	3,42	360	7,65	4,71	360
380				5,56	3,42	380	7,65	4,71	380
400				5,56	3,42	400	7,65	4,71	400
420				5,56	3,42	420			
440				5,56	3,42	440			
460				5,56	3,42	460			
480				5,56	3,42	480			
500				5,56	3,42	500			
550				5,56	3,42	550			
600				5,56	3,42	600			

Calculated according to EN 1995-1-1, with non-predrilled holes and wood density  $\rho_k = 350 \text{ kg/m}^3$ . Design values  $F_{v,Rd}$  calculated considering  $k_{mod} = 0,8$  and  $\gamma_m = 1,3$ . L is the minimum screw length for achieving the respective load-carrying capacity.

Please note: these are planning aids. Projects must be calculated only by authorized persons.

## SAWTEC – STEEL-TIMBER, THIN PLATE



Lateral load-carrying capacity of screws with minimum required lengths.

A [mm]	Ø 6 mm $t_s \leq 3$ mm			Ø 8 mm $t_s \leq 4$ mm			Ø 10 mm $t_s \leq 5$ mm		
	$\alpha_A = 90^\circ$								
	$F_{v,Rk}$ [kN]	$F_{v,Rd}$ [kN]	L [mm]	$F_{v,Rk}$ [kN]	$F_{v,Rd}$ [kN]	L [mm]	$F_{v,Rk}$ [kN]	$F_{v,Rd}$ [kN]	L [mm]
60	2,21	1,36	60						
70	2,31	1,42	70						
80	2,41	1,48	80	3,87	2,38	80			
90	2,41	1,48	80	3,87	2,38	80			
100	2,62	1,61	100	4,09	2,52	100	5,66	3,48	100
110	2,62	1,61	100	4,09	2,52	100	5,66	3,48	100
120	2,79	1,72	120	4,31	2,65	120	5,93	3,65	120
140	2,79	1,72	140	4,53	2,79	140	6,20	3,82	140
150	2,79	1,72	140	4,53	2,79	140	6,20	3,82	140
160	2,79	1,72	160	4,76	2,93	160	6,47	3,98	160
180	2,79	1,72	180	4,98	3,06	180	6,74	4,15	180
200				4,98	3,06	200	6,74	4,15	200
220				4,98	3,06	220	6,74	4,15	220
240				4,98	3,06	240	6,74	4,15	240
260				4,98	3,06	260	6,74	4,15	260
280				4,98	3,06	280	6,74	4,15	280
300				4,98	3,06	300	6,74	4,15	300
320				4,98	3,06	320	6,74	4,15	320
340				4,98	3,06	340	6,74	4,15	340
360				4,98	3,06	360	6,74	4,15	360
380				4,98	3,06	380	6,74	4,15	380
400				4,98	3,06	400	6,74	4,15	400
420				4,98	3,06	420			
440				4,98	3,06	440			
460				4,98	3,06	460			
480				4,98	3,06	480			
500				4,98	3,06	500			
550				4,98	3,06	550			
600				4,98	3,06	600			

Calculated according to EN 1995-1-1, with non-pre-drilled holes and wood density  $\rho_k = 350 \text{ kg/m}^3$ . Design values  $F_{Rd}$  calculated considering  $k_{mod} = 0,8$  and  $\gamma_M = 1,3$ . L is the minimum screw length for achieving the respective load-carrying capacity.

Please note: these are planning aids. Projects must be calculated only by authorized persons.

## SAWTEC – STEEL-TIMBER, THICK PLATE

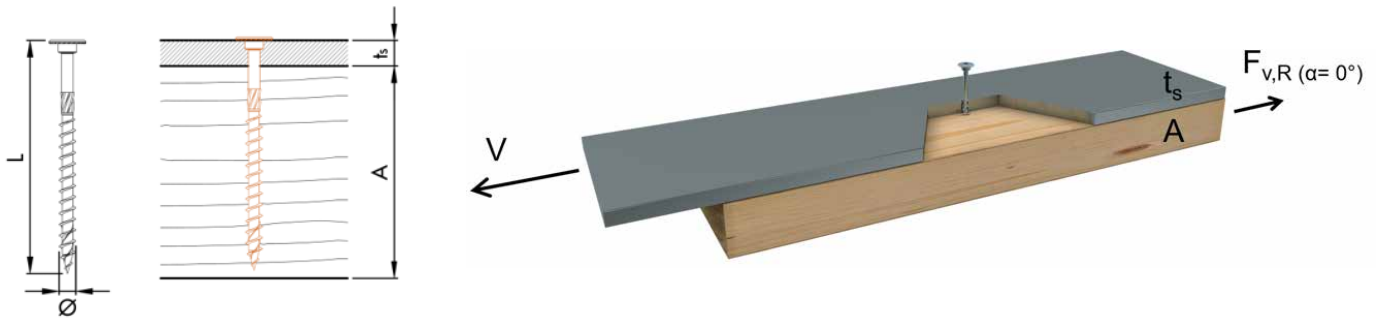

Lateral load-carrying capacity of screws with minimum required lengths.

A [mm]	Ø 6 mm 6 mm ≤ t <sub>s</sub> ≤ 9 mm			Ø 8 mm 8 mm ≤ t <sub>s</sub> ≤ 12 mm			Ø 10 mm 10 mm ≤ t <sub>s</sub> ≤ 15 mm		
	α <sub>A</sub> = 0°								
	F <sub>v,Rk</sub> [kN]	F <sub>v,Rd</sub> [kN]	L [mm]	F <sub>v,Rk</sub> [kN]	F <sub>v,Rd</sub> [kN]	L [mm]	F <sub>v,Rk</sub> [kN]	F <sub>v,Rd</sub> [kN]	L [mm]
60	2,86	1,76	60						
70	2,97	1,83	70						
80	3,07	1,89	80	5,84	3,59	80			
90	3,07	1,89	80	5,84	3,59	80			
100	3,27	2,01	100	6,06	3,73	100	8,61	5,30	100
110	3,27	2,01	100	6,06	3,73	100	8,61	5,30	100
120	3,45	2,12	120	6,28	3,86	120	8,88	5,46	120
140	3,45	2,12	140	6,50	4,00	140	9,15	5,63	140
150	3,45	2,12	140	6,50	4,00	140	9,15	5,63	140
160	3,45	2,12	160	6,73	4,14	160	9,42	5,80	160
180	3,45	2,12	180	6,95	4,28	180	9,69	5,96	180
200				6,95	4,28	200	9,69	5,96	200
220				6,95	4,28	220	9,69	5,96	220
240				6,95	4,28	240	9,69	5,96	240
260				6,95	4,28	260	9,69	5,96	260
280				6,95	4,28	280	9,69	5,96	280
300				6,95	4,28	300	9,69	5,96	300
320				6,95	4,28	320	9,69	5,96	320
340				6,95	4,28	340	9,69	5,96	340
360				6,95	4,28	360	9,69	5,96	360
380				6,95	4,28	380	9,69	5,96	380
400				6,95	4,28	400	9,69	5,96	400
420				6,95	4,28	420			
440				6,95	4,28	440			
460				6,95	4,28	460			
480				6,95	4,28	480			
500				6,95	4,28	500			
550				6,95	4,28	550			
600				6,95	4,28	600			

Calculated according to EN 1995-1-1, considering non-pre-drilled holes and wood density ρ<sub>k</sub> = 350 kg/m<sup>3</sup>. Design values F<sub>Rd</sub> calculated considering k<sub>mod</sub> = 0,8 and γ<sub>M</sub> = 1,3. L is the minimum screw length for achieving the respective load-carrying capacity.

Please note: these are planning aids. Projects must be calculated only by authorized persons.

## SAWTEC – STEEL-TIMBER, THICK PLATE



Lateral load-carrying capacity of screws with minimum required lengths.

A [mm]	Ø 6 mm $6 \text{ mm} \leq t_s \leq 9 \text{ mm}$			Ø 8 mm $8 \text{ mm} \leq t_s \leq 12 \text{ mm}$			Ø 10 mm $10 \text{ mm} \leq t_s \leq 15 \text{ mm}$		
	$\alpha_A = 90^\circ$								
	$F_{v,Rk}$ [kN]	$F_{v,Rd}$ [kN]	L [mm]	$F_{v,Rk}$ [kN]	$F_{v,Rd}$ [kN]	L [mm]	$F_{v,Rk}$ [kN]	$F_{v,Rd}$ [kN]	L [mm]
60	2,86	1,76	60						
70	2,97	1,83	70						
80	3,07	1,89	80	5,01	3,08	80			
90	3,07	1,89	80	5,01	3,08	80			
100	3,27	2,01	100	5,23	3,22	100	7,33	4,51	100
110	3,27	2,01	100	5,23	3,22	100	7,33	4,51	100
120	3,45	2,12	120	5,45	3,35	120	7,60	4,68	120
140	3,45	2,12	140	5,68	3,50	140	7,87	4,84	140
150	3,45	2,12	140	5,68	3,50	140	7,87	4,84	140
160	3,45	2,12	160	5,90	3,63	160	8,14	5,01	160
180	3,45	2,12	180	6,12	3,77	180	8,41	5,18	180
200				6,12	3,77	200	8,41	5,18	200
220				6,12	3,77	220	8,41	5,18	220
240				6,12	3,77	240	8,41	5,18	240
260				6,12	3,77	260	8,41	5,18	260
280				6,12	3,77	280	8,41	5,18	280
300				6,12	3,77	300	8,41	5,18	300
320				6,12	3,77	320	8,41	5,18	320
340				6,12	3,77	340	8,41	5,18	340
360				6,12	3,77	360	8,41	5,18	360
380				6,12	3,77	380	8,41	5,18	380
400				6,12	3,77	400	8,41	5,18	400
420				6,12	3,77	420			
440				6,12	3,77	440			
460				6,12	3,77	460			
480				6,12	3,77	480			
500				6,12	3,77	500			
550				6,12	3,77	550			
600				6,12	3,77	600			

Calculated according to EN 1995-1-1, considering non-pre-drilled holes and wood density  $\rho_k = 350 \text{ kg/m}^3$ . Design values  $F_{v,Rd}$  calculated considering  $k_{mod} = 0,8$  and  $\gamma_m = 1,3$ . L is the minimum screw length for achieving the respective load-carrying capacity.

**Please note:** these are planning aids. Projects must be calculated only by authorized persons.

# TOPDUO

The double threaded screw for all over-rafter insulation systems



The Topduo roofing screw can be used to fasten both compression-resistant and non-compression-resistant above-rafter insulation. The **high pull-out resistance** in both connecting timbers also makes the Topduo roofing screw suitable for many other applications in timber construction. The screw has a double thread and is available with a flanged buttonhead and cylinder head.

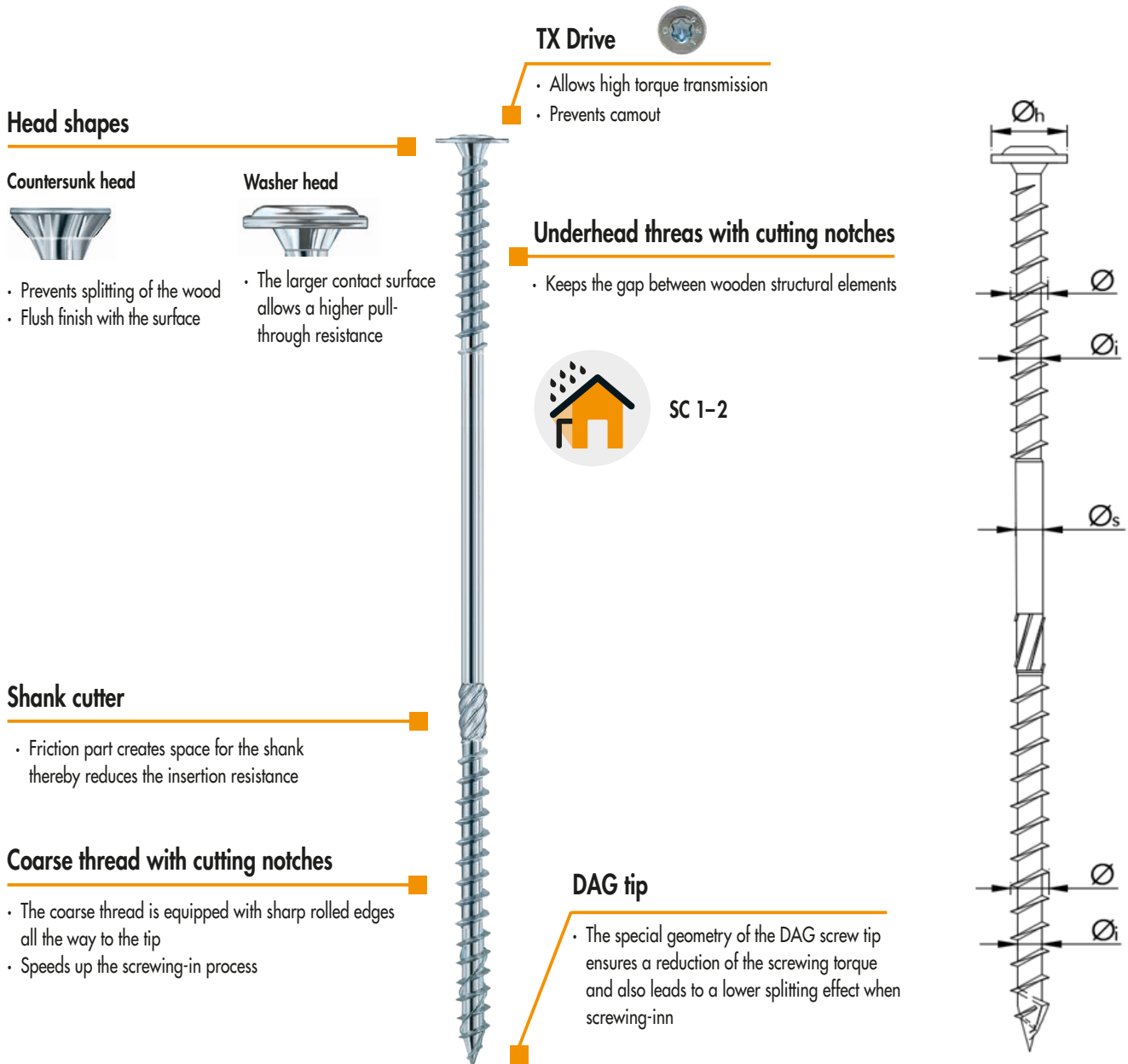

Topduo									
Geometric properties						Mechanical properties			
Nominal Ø [mm]	Inner Ø <sub>i</sub> [mm]	Shaft Ø <sub>s</sub> [mm]	Head <sup>a)</sup> Ø <sub>h</sub> [mm]	Higher thread length [mm]	Lower thread length [mm]	f <sub>tens,k</sub> [kN]	f <sub>ax,k</sub> [MPa]	f <sub>head,k<sup>b)</sup></sub> [MPa]	M <sub>y,k</sub> [Nm]
8	5,3	5,8	10,0 / 16,0	32-100	32-60	20,0	11,1	10,0	20,0

a) Cylinder head / Washer head

b) The axial capacity of a double threaded screw may be determined maximum value between withdrawal and pull-through capacity  $F_{ax,Rd} = \max [F_{ax,\alpha,Rd}; F_{head,Rd}]$

## QUANTITY OF TOPDUO SCREWS FOR STATICALLY NON-PRESSURE-RESISTANT INSULATING MATERIALS AT $\sigma_{10} \% < 50$ KPA

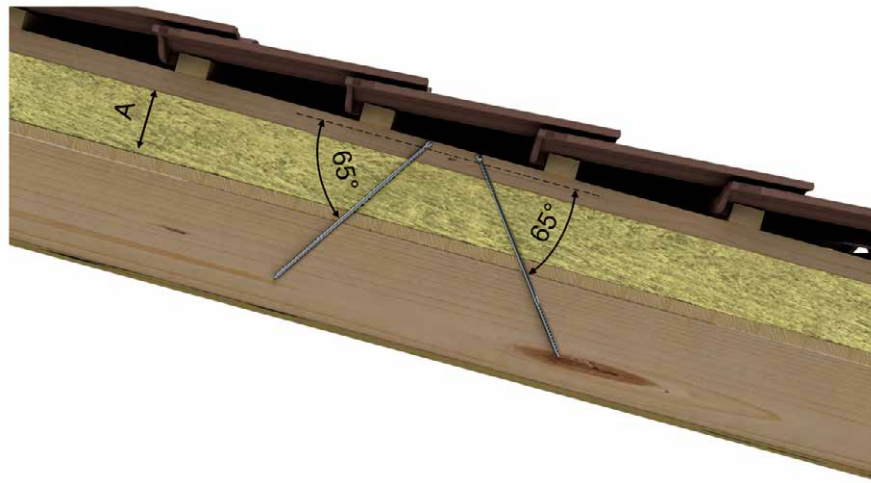

		Ø 8 mm							
A [mm]	L [mm]	Snow load zone 2 <sup>*b)</sup> Wind zone 4 <sup>c)</sup> Altitude NN ≤ 285 m				Snow load zone 3 <sup>d)</sup> Wind zone 2 <sup>e)</sup> Altitude NN ≤ 600 m			
		0° ≤ DN ≤ 10°	10° ≤ DN ≤ 25°	25° ≤ DN ≤ 40°	40° ≤ DN ≤ 60°	0° ≤ DN ≤ 10°	10° ≤ DN ≤ 25°	25° ≤ DN ≤ 40°	40° ≤ DN ≤ 60°
		Number of required screws per m <sup>2</sup> of roof							
40	165 <sup>a)</sup>	2,20	2,38	2,72	2,86	1,79	2,29	2,38	2,60
60	195 <sup>a)</sup>	2,20	2,38	2,72	3,01	1,79	2,29	2,48	2,60
80	225	2,38	2,60	3,01	3,17	1,97	2,48	2,72	2,86
100	235	2,38	2,60	3,01	3,17	2,04	2,60	2,72	2,86
120	255	2,38	2,60	3,01	3,36	2,04	2,60	2,72	2,86
140*	275	2,38	2,60	3,01	3,36	2,04	2,60	2,86	2,86
140	302	2,38	2,60	3,01	3,36	2,04	2,60	2,86	2,86
160	335	2,29	2,60	3,01	3,36	2,12	2,72	2,86	3,01
180	335	2,29	2,60	3,01	3,36	2,60	3,36	3,57	3,57
200	365	2,48	3,17	3,57	3,57	3,81	4,76	5,19	5,19
220	365	3,01	3,81	4,40	4,40	4,40	f)	f)	f)
240	397	3,57	4,40	5,19	5,19	5,19	f)	f)	f)
260	435	4,08	f)	f)	f)	f)	f)	f)	f)
280	435	4,76	f)	f)	f)	f)	f)	f)	f)

\* Without boarding above rafters

<sup>a)</sup> Topduo washer head only

<sup>b)</sup> Includes snow load zones 1, 2, and 2<sup>c)</sup>; <sup>c)</sup> Includes all wind zones except the North Sea Islands

<sup>d)</sup> Includes snow load zones 1, 2, and 3; <sup>e)</sup> Includes wind zones 1 and 2 (inland)

<sup>f)</sup> Use of our project assessment service is recommended

Designed with ECS design software in accordance with ETA-11/0024; boarding thickness above rafters of 24 mm; screwing angle of 65°; gable roof; ridge height above ground max. 18 m; gross density insulation 1,50 kN/m<sup>3</sup>; rafters C24 8 / ≥12 cm; counter batten C24 4 / 6 cm; rafter center distance 0,70 m; roofing dead weight 0,55 kN/m<sup>2</sup>; snow guard considered; quantity calculation with respect to wind pressure after the most unfavorable roof area. Project-related design may yield significantly more favorable results.

**Please note:** these are planning aids. Projects must be calculated only by authorized persons.

## QUANTITY OF TOPDUO SCREWS FOR STATICALLY NON-PRESSURE-RESISTANT INSULATING MATERIALS AT $\sigma_{10} \% \geq 50$ KPA

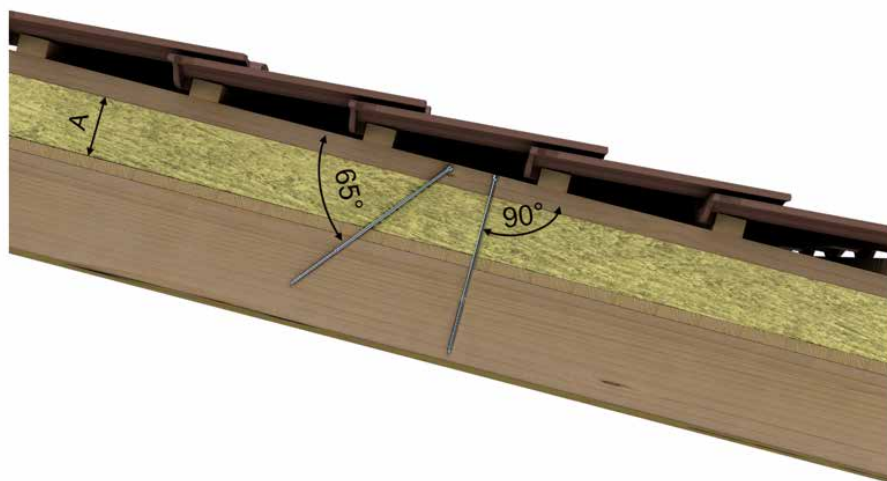

		Ø 8 mm							
A [mm]	L [mm]	Snow load zone 2 <sup>*b)</sup> Wind zone 4 <sup>c)</sup> Altitude NN ≤ 285 m			Snow load zone 3 <sup>d)</sup> Wind zone 2 <sup>e)</sup> Altitude NN ≤ 400 m				
		0° ≤ DN ≤ 10°	10° ≤ DN ≤ 25°	25° ≤ DN ≤ 40°	0° ≤ DN ≤ 10°	0° ≤ DN ≤ 10°	10° ≤ DN ≤ 25°	0° ≤ DN ≤ 10°	40° ≤ DN ≤ 60°
		Number of required screws per m <sup>2</sup> of roof							
40	195 <sup>a)</sup>	1,96	2,11	2,48	2,31	2,65	4,04	4,46	3,55
60	225	2,06	2,05	2,41	2,30	2,54	3,81	4,16	3,26
80	235	2,06	1,97	2,28	2,56	2,39	3,55	3,84	3,26
100	255	2,06	1,94	2,35	2,65	2,34	3,33	3,58	3,26
120	275	2,06	1,97	2,41	2,74	2,26	3,33	3,58	3,44
140	302	2,06	1,90	2,35	2,65	2,23	3,15	3,58	3,26
160	335	2,06	1,85	2,18	2,42	2,34	3,15	3,37	2,96
180	335	2,06	2,14	2,67	2,96	2,34	2,99	3,37	3,66
200	365	2,06	2,01	2,49	2,74	2,16	2,99	3,37	3,44
220	365	2,06	2,74	3,48	4,00	2,46	3,66	4,67	f)
240	397	2,12	2,57	3,22	3,70	2,32	3,37	4,20	4,67
260	435	1,80	2,38	2,96	3,48	2,19	3,06	3,92	4,27
280	435	2,40	3,23	4,42	4,87	2,86	4,37	f)	f)
300	472 <sup>a)</sup>	2,32	2,93	3,79	4,47	2,65	3,74	f)	f)

<sup>a)</sup> Topduo washer head only

<sup>b)</sup> Includes snow load zones 1, 2, and 2<sup>\*</sup>. <sup>c)</sup> Includes all wind zones except the North Sea Islands

<sup>d)</sup> Includes snow load zones 1, 2, and 3; <sup>e)</sup> Includes wind zones 1 and 2 (inland)

<sup>f)</sup> Use of our project assessment service is recommended

Designed with ECS design software in accordance with ETA-11/0024; boarding thickness above rafters of 24 mm; screwing angles of 65° for shear screws and 90° for wind pressure screws; gable roof; ridge height above ground max. 18 m; gross density insulation 1,50 kN/m<sup>3</sup>; rafters C24 8/≥12 cm; counter batten C24 4/6 cm; rafter center distance 0,70 m; roofing dead weight 0,55 kN/m<sup>2</sup>; snow guard considered; quantity calculation with respect to wind pressure after the most unfavorable roof area. Project-related design may yield significantly more favorable results.

**Please note:** these are planning aids. Projects must be calculated only by authorized persons.



# ANGLE BRACKET SCREW (ABS)

For quick and easy screwing in



The Eurotec Angle-bracket screw (ABS) is made of **hardened carbon steel** and is specially designed for **joints between steel sheet and wood**. The splitting effect in the wood is reduced by the geometry of the screw tip. In addition, the screw is characterized, among other things, by the smooth **shank under the head**, which allows **load transfer during shearing**.

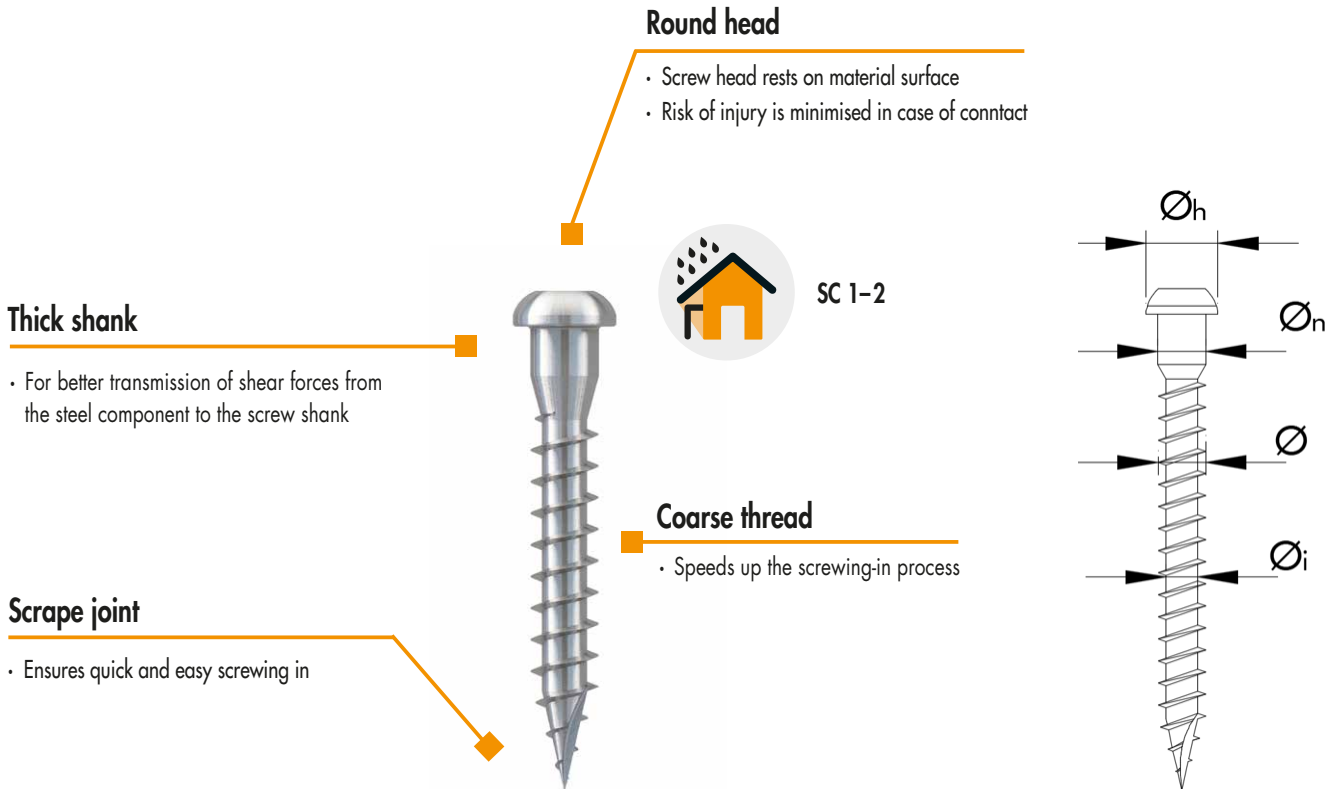

Angle bracket screw (ABS)						
Geometric properties				Mechanical properties		
Nominal Ø [mm]	Inner Ø <sub>i</sub> [mm]	Neck Ø <sub>n</sub> [mm]	Head Ø <sub>h</sub> [mm]	f <sub>tens,k</sub> [kN]	f <sub>ax,k</sub> [MPa]	M <sub>y,k</sub> [Nm]
5	3,2	4,8	7,2	7,9	12,1	5,9

# MINIMUM DISTANCES FOR SHEAR LOADS

Angle-bracket screw (ABS)

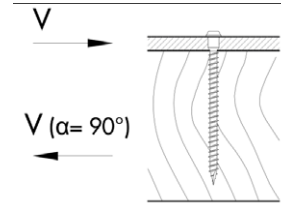
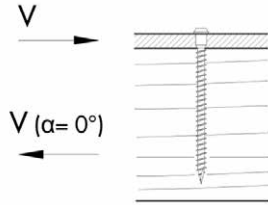

Ø [mm]	Predrilled holes		Non-predrilled holes		Predrilled holes		Non-predrilled holes	
	Rules	5	Rules	5	Rules	5	Rules	5
a <sub>1</sub>	3,5 · d	18	8,4 · d	42	2,8 · d	14	3,5 · d	18
a <sub>2</sub>	2,1 · d	11	3,5 · d	18	2,8 · d	14	3,5 · d	18
a <sub>3,c</sub>	7 · d	35	10 · d	50	7 · d	35	10 · d	50
a <sub>3,t</sub>	12 · d	60	15 · d	75	7 · d	35	10 · d	50
a <sub>4,c</sub>	3 · d	15	5 · d	25	3 · d	15	5 · d	25
a <sub>4,t</sub>	3 · d	15	5 · d	25	7 · d	35	10 · d	50

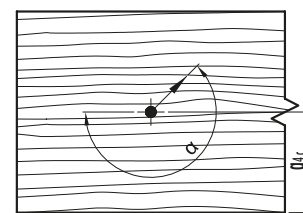
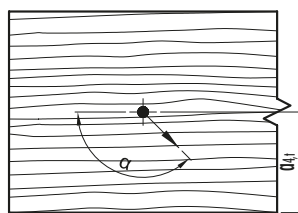
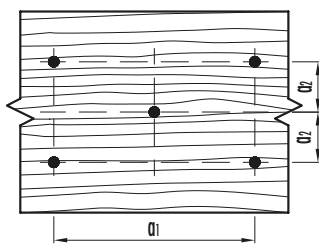
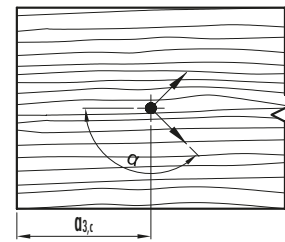
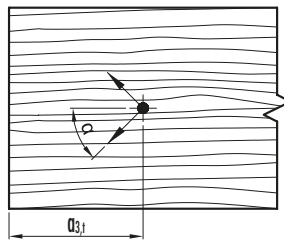
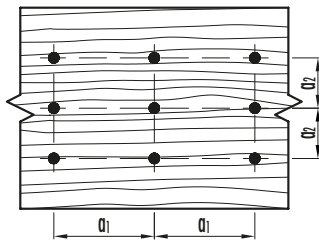

**Notes:** The minimum distances for lateral load-carrying screws are based on EN 1995:2014 considering a softwood density of  $\rho_k \leq 420 \text{ kg/m}^3$ , where  $d$  = nominal screw diameter. For timber-to-timber joints, the axial distances of  $a_1$  and  $a_2$  must be increased by 1,43.

## ABS (ANGLE-BRACKET SCREW) STEEL-TIMBER

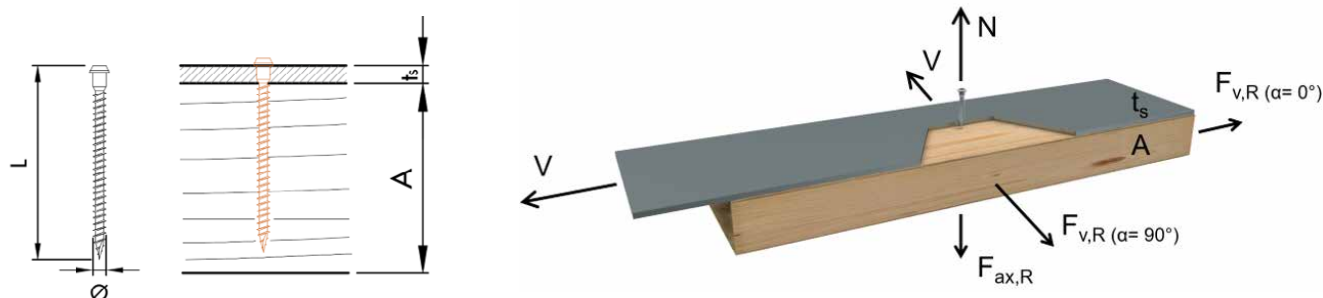

Lateral load-carrying capacity of screws with minimum required lengths.

		Ø 5 mm									
		$\alpha_A = 0^\circ; \alpha_A = 90^\circ$									
		$t_s = 1,5 \text{ mm}$		$t_s = 2 \text{ mm}$		$t_s = 3 \text{ mm}$		$t_s = 4 \text{ mm}$		$t_s \leq 9 \text{ mm}$	
A [mm]	L [mm]	$F_{v,Rk}$ [kN]	$F_{v,Rd}$ [kN]	$F_{v,Rk}$ [kN]	$F_{v,Rd}$ [kN]	$F_{v,Rk}$ [kN]	$F_{v,Rd}$ [kN]	$F_{v,Rk}$ [kN]	$F_{v,Rd}$ [kN]	$F_{v,Rk}$ [kN]	$F_{v,Rd}$ [kN]
25	25	0,83	0,51	1,43	0,88	1,41	0,87	1,38	0,85	0,97	0,60
35	35	1,19	0,73	1,85	1,14	1,82	1,12	1,79	1,10	1,57	0,97
40	40	1,36	0,84	2,08	1,28	2,05	1,26	2,02	1,24	1,88	1,16
50	50	1,72	1,06	2,28	1,40	2,28	1,40	2,28	1,40	2,48	1,53
60	60	1,95	1,20	2,43	1,50	2,43	1,50	2,43	1,50	3,09	1,90
70	70	2,10	1,29	2,59	1,59	2,59	1,59	2,59	1,59	3,69	2,27

Calculated according to EN 1995-1-1, considering non-predrilled holes and wood density  $\rho_k = 350 \text{ kg/m}^3$ . Design values  $F_{v,Rd}$  calculated considering  $k_{mod} = 0,8$  and  $\gamma_M = 1,3$ . A thick plate is considered for  $t_s \geq 2 \text{ mm}$  according to ETA-11/0024. L is the minimum screw length for achieving the respective load-carrying capacity.

**Please note:** these are planning aids. Projects must be calculated only by authorized persons.

# ANCHOR NAIL

High strength with the quickest installation



The hardened carbon steel anchor nail was developed **for connections between sheet steel and wood**. They are mainly used in structural timber construction and represent an alternative to screwing. Like other nails, anchor nails are hammered in with a hammer. Due to the grooved profile, these are particularly tight after being hammered in and are difficult to pull out. **The pull-out strength of an anchor nail comes very close to that of a screw**. The conical attachment under the **flat head ensures a force-fitting** and centered fit in the hole of a wood connector.

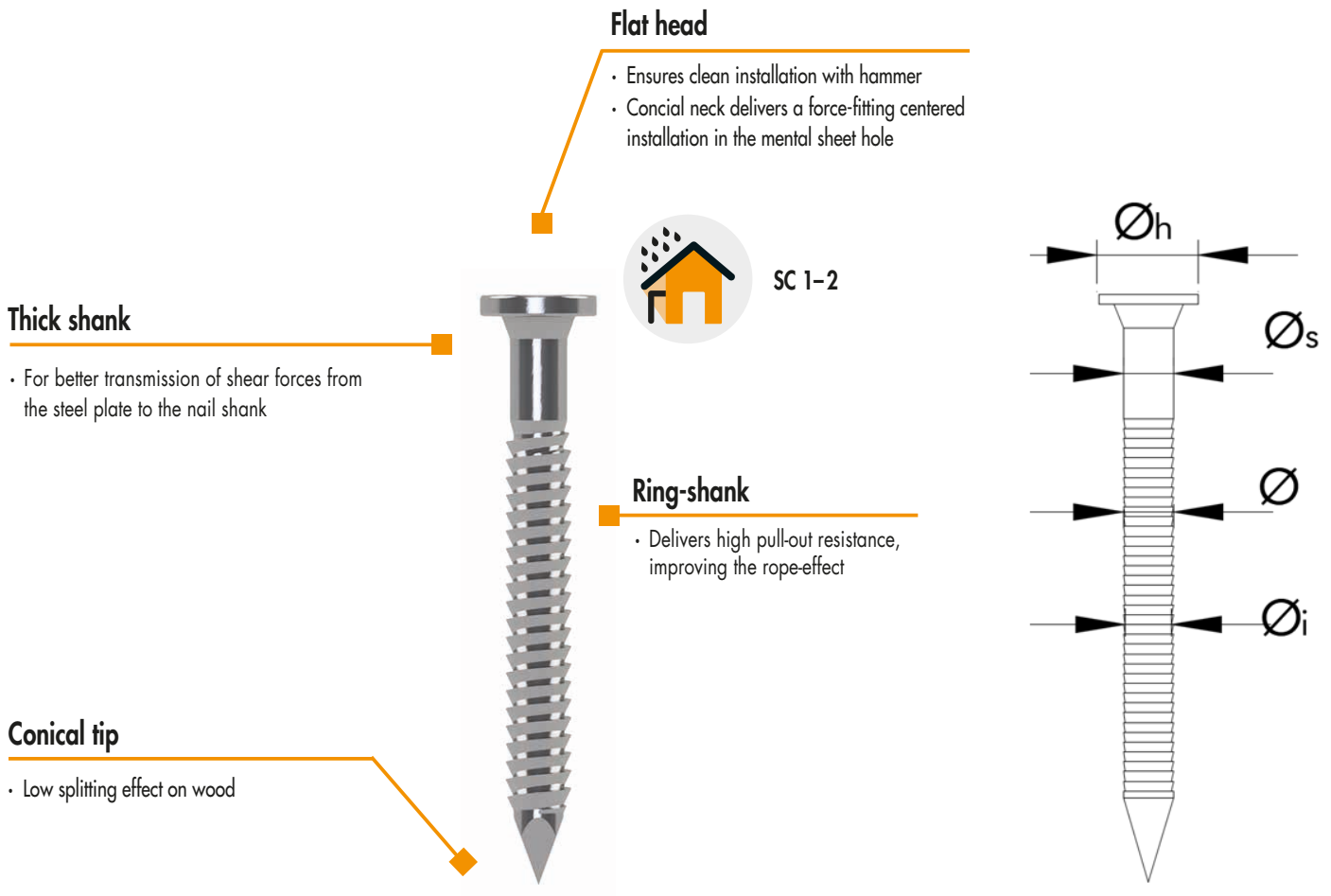

Anchor nail							
Geometric properties					Mechanical properties		
$\varnothing \times L$ [mm]	Inner $\varnothing_i$ [mm]	Shank $\varnothing_s$ [mm]	Head $\varnothing_h$ [mm]	Threaded length with tip [mm]	$f_{tens,k}$ [kN]	$f_{ax,k}$ [MPa]	$M_{y,k}$ [Nm]
4 x 40	3,4	3,9	8,0	30,0	8,0	4,84	6,5
4 x 50	3,4	3,9	8,0	40,0	8,0	5,09	6,5
4 x 60	3,4	3,9	8,0	50,0	8,0	5,23	6,5

# MINIMUM DISTANCES FOR SHEAR LOADS

## Anchor nail

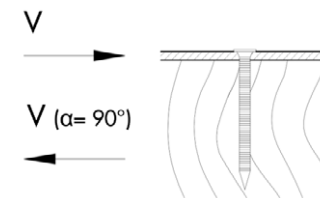
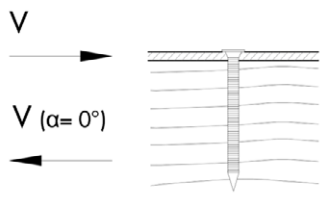

Ø [mm]	Predrilled holes		Non-predrilled holes		Predrilled holes		Non-predrilled holes	
	Rules	4	Rules	4	Rules	4	Rules	4
$a_1$	$3,5 \cdot d$	14	$7 \cdot d$	28	$2,8 \cdot d$	11	$3,5 \cdot d$	14
$a_2$	$2,1 \cdot d$	9	$3,5 \cdot d$	14	$2,8 \cdot d$	11	$3,5 \cdot d$	14
$a_{3,c}$	$7 \cdot d$	28	$10 \cdot d$	40	$7 \cdot d$	28	$10 \cdot d$	40
$a_{3,t}$	$12 \cdot d$	48	$15 \cdot d$	60	$7 \cdot d$	28	$10 \cdot d$	40
$a_{4,c}$	$3 \cdot d$	12	$5 \cdot d$	20	$3 \cdot d$	12	$5 \cdot d$	20
$a_{4,t}$	$3 \cdot d$	12	$5 \cdot d$	20	$5 \cdot d$	20	$7 \cdot d$	28

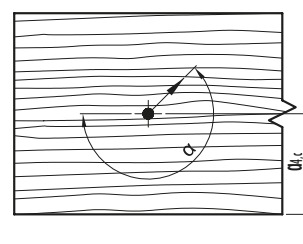
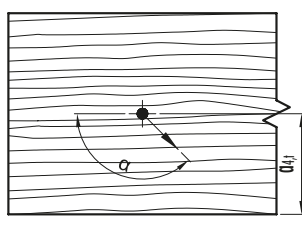
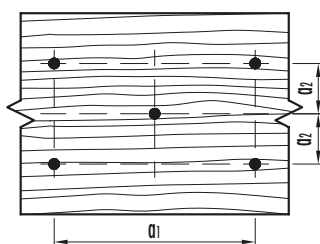
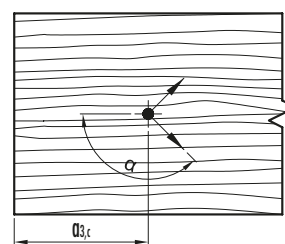
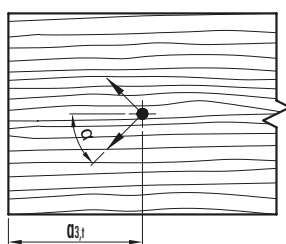
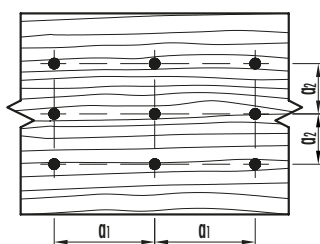

**Notes:** The minimum distances for lateral load-carrying screws are based on EN 1995:2014 considering a softwood density of  $\rho_k \leq 420 \text{ kg/m}^3$ , where  $d$  = nominal screw diameter. For timber-to-timber joints, the axial distances of  $a_1$  and  $a_2$  must be increased by 1,43.

## ANCHOR NAILS – STEEL-TIMBER

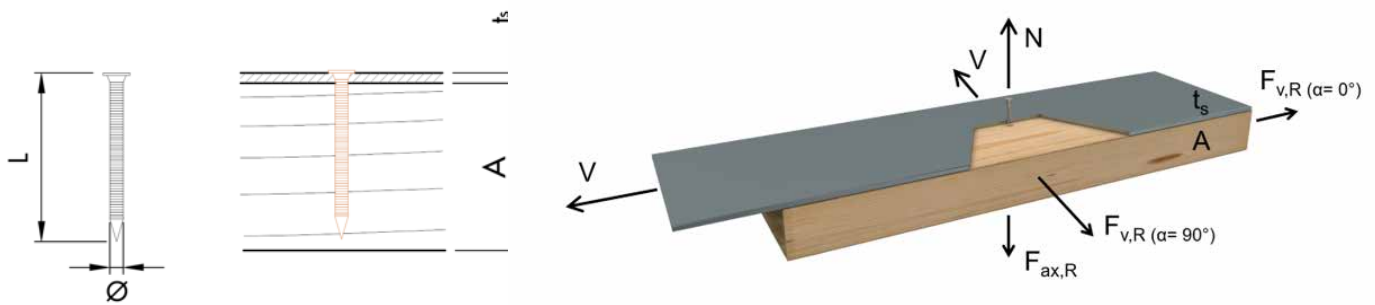

Load-carrying capacities of screws with minimum required lengths.

		Ø 4 mm									
		$\alpha_A = 0^\circ; \alpha_A = 90^\circ$								Axial loads	
		$t_s = 0,9 \text{ mm}$		$t_s = 1,5 \text{ mm}$		$t_s = 3 \text{ mm}$		$t_s = 4 \text{ mm}$		$t_s \leq 9 \text{ mm}$	
A [mm]	L [mm]	$F_{v,Rk}$ [kN]	$F_{v,Rd}$ [kN]	$F_{v,Rk}$ [kN]	$F_{v,Rd}$ [kN]	$F_{v,Rk}$ [kN]	$F_{v,Rd}$ [kN]	$F_{v,Rk}$ [kN]	$F_{v,Rd}$ [kN]	$F_{ax,Rk}$ [kN]	$F_{ax,Rd}$ [kN]
40	40	1,18	0,73	1,90	1,17	1,90	1,17	1,90	1,17	0,58	0,36
50	50	1,49	0,92	2,28	1,40	2,28	1,40	2,28	1,40	0,81	0,5
60	60	1,79	1,10	2,43	1,50	2,43	1,50	2,43	1,50	1,05	0,64

Calculated according to EN 1995-1-1, considering non-predrilled holes and wood density  $\rho_k = 350 \text{ kg/m}^3$ . Design values  $F_{Rd}$  calculated considering  $k_{mod} = 0,8$  and  $\gamma_M = 1,3$ . A thick plate is considered for  $t_s \geq 1,5 \text{ mm}$  according to ETA-22/0083. L is the minimum screw length for achieving the respective load-carrying capacity.

**Please note:** these are planning aids. Projects must be calculated only by authorized persons.



The specialist for fastening technology

MORE INFORMATION  
ABOUT OUR  
**STRUCTURAL  
WOOD SCREWS**

OUR STRUCTURAL  
WOOD SCREWS



25  
YEARS

**E.u.ro.Tec GmbH**

Unter dem Hofe 5

D-58099 Hagen

Tel. +49 2331 62 45-0

Fax +49 2331 62 45-200

E-Mail [info@eurotec.team](mailto:info@eurotec.team)

[www.eurotec.team/en](http://www.eurotec.team/en)