

FASTENING RECOMMENDATION

COURBARIL (JATOBÁ (HYMENEAE SPP.))

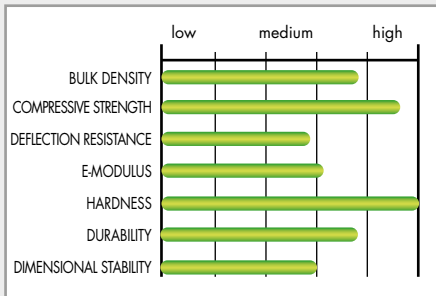

ADVANTAGES

- + High durability
- + No washing out
- + Extremely high strength
- + Extremely high hardness

DISADVANTAGES

- Only moderate dimensional stability
- Often originates from overexploitation (use only certified timber wherever possible)

GENERAL DETAILS

- **Origin:** Central and South America
- **Colour:** Trade name encompasses various species, usually salmon-coloured to yellowish brown, often later darkening to orange-brown to copper-coloured.
- **Durability class:** 1 – 3
- **Properties:** High swelling and shrinkage, good to satisfactory dimensional stability, high strength, extremely high hardness, very decorative.

APPLICATION

Deck construction, solid wood floorboards, heavy-duty flooring, furniture, structural timber.



INSTALLATION INSTRUCTIONS

- Centre distance in substructure: max. 60 cm
- Joint width between boards: 6 to 8 mm
- Spacing between butt joints: 3 to 4 mm



FASTENING OPTIONS

VISIBLE



Terrasotec Trilobular



Hapatec Heli



Profile drilling screw A4



Distance strip 2.0

FASTENING RECOMMENDATION COURBARIL

BOARD CROSS SECTION

To guarantee a long service life for boards, a minimum board thickness should be chosen according to the centre distance for the substructure and the required board width. The following table shows the relevant recommendation for your board and the associated centre distance for the substructure.

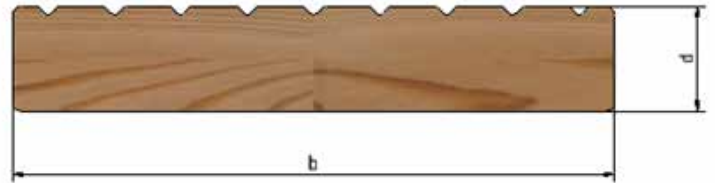

Board width b [mm]	Spacing for the substructure [cm]	
	50	60
	Minimum board thickness d [mm]	
100	30	32
120	27	30
140	25	27
160	23	26

MAXIMUM SPACING FOR THE SUBSTRUCTURE

The correct spacing of the substructure is important to ensure the plank load-bearing capacity.

Our recommendation here is a **maximum distance of 60 cm** for Courbaril decking boards.

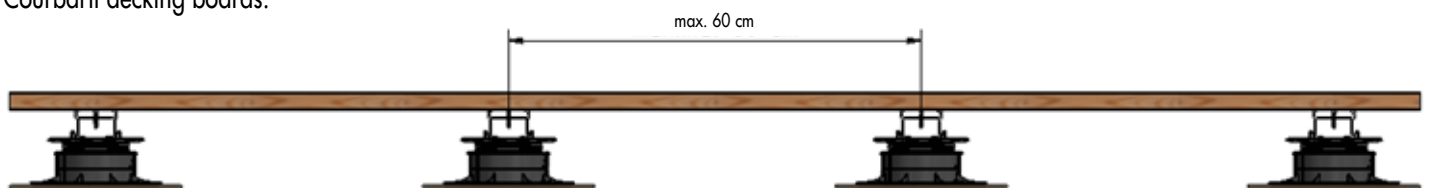

JOINT WIDTHS

Given that wood swells and shrinks most in the width of the board, correct joint width is key to the life of a terrace.

For a terrace with Courbaril planks, we recommend a **joint width of 6 to 8 mm**.

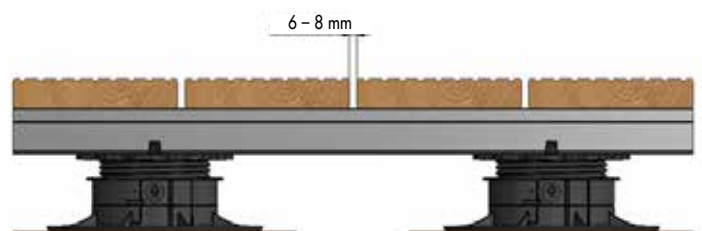

FASTENING RECOMMENDATION COURBARIL

BOARD JOINTS

Not only is it necessary to incorporate board joints in the planning of a substructure, but also to implement them correctly so that the timber can swell and shrink, thereby retaining the visual appearance of the terrace while preventing damage.

For Courbaril, we recommend a distance for the plank joints of **3 – 4 mm** not to be under or exceeded.

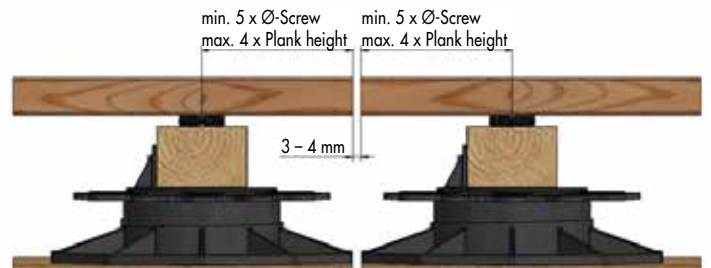

PRE-DRILLING

When building a terrace with wooden planks made of Courbaril, pre-drilling and countersinking is absolutely recommended. These tend to crack easily and there is a risk of splitting, which is prevented by pre-drilling. The additional countersinking significantly minimises the possibility of chip build-up around the screw head and ensures a more attractive screw pattern.



Art. no.	Name	PU
945986	Drill-Stop	1

POSSIBLE FASTENINGS FOR YOUR BOARDS

Decking boards made of Courbaril are not suitable for indirect fastening due to their high swelling and shrinkage behaviour. Therefore, we only recommend products for visible screw connection.

VISIBLE FASTENING

COURBARIL

SCREWS FOR DIRECT/VISIBLE FASTENING

TERRASOTEC TRILOBULAR, STAINLESS STEEL A4

The Terrasotec screw is designed for the fastening of wooden floorboards on a wooden substructure and is not suitable for fastening on an aluminium substructure.

Art. no.	Dimensions [mm]	Drive	PU
905555	5,5 x 50	TX25	100
905556	5,5 x 60	TX25	100
905557	5,5 x 70	TX25	100
905558	5,5 x 80	TX25	100
905547*	5,5 x 90	TX25	100
905548*	5,5 x 100	TX25	100

*The previous version will continue to be supplied until the switchover is complete.

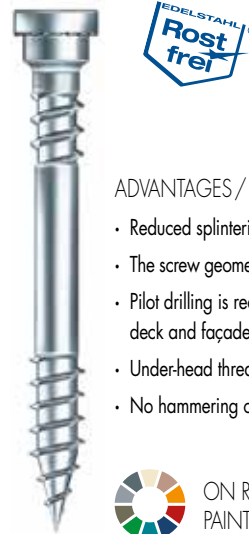

ADVANTAGES / PROPERTIES

- Reduced splintering through special head
- The screw geometry reduces the danger of splitting,
- Pilot drilling is recommended in particular for hardwoods and in deck and façade construction!
- Under-head thread provides additional hold for deck boards
- No hammering of the screws through TX drive



ON REQUEST, SCREW HEADS CAN BE PAINTED IN RAL COLOURS

APPLICATION IMAGE



The Terrasotec Trilobular, stainless steel A4 is screwed into the Courbaril decking.

VISIBLE FASTENING

HAPATEC HELI, A4

The Hapatec screw is designed for fixing wooden planks to a wooden substructure and is not suitable for fixing to an aluminium substructure.

Art. no.	Dimensions [mm]	Drive	PU
100051	5,0 x 50	TX25	200
100052	5,0 x 60	TX25	200
100053	5,0 x 70	TX25	200
100054	5,0 x 80	TX25	200
100058	5,0 x 100	TX25	200

COURBARIL



ADVANTAGES / PROPERTIES

- Suitable for use with woods containing tanning agents such as cumarú, oak, merbau, robinia, etc.
- Suitable for saline atmospheres
- Limited resistance to acid
- Not suitable for use in chlorous atmospheres



ON REQUEST, SCREW HEADS CAN BE PAINTED IN RAL COLOURS

APPLICATION IMAGE

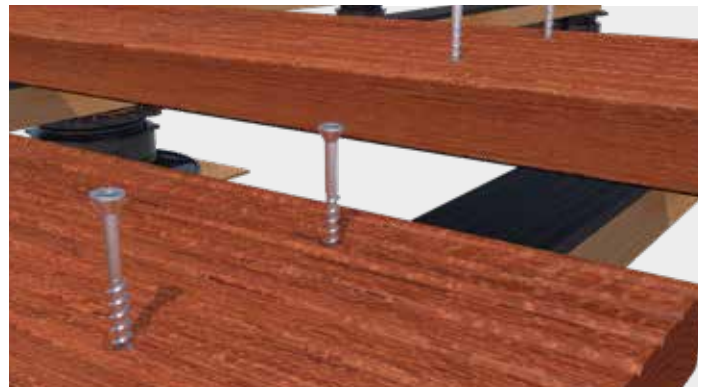

The Hapatec Heli, A4 is screwed into the Courbaril decking.

VISIBLE FASTENING

PROFILE DRILLING SCREW, STAINLESS STEEL A4

The profile drilling screw is designed to fasten wooden boards to a substructure of aluminium profiles; it is not suitable for fastening boards to a wood substructure.

Art. no.	Dimensions [mm]	Drive	Board thickness [mm]	PU
905571	5,5 x 41	TX25	16 – 20	200
905563	5,5 x 46	TX25	21 – 25	200
905564	5,5 x 51	TX25	26 – 30	200
975798	5,5 x 56	TX25	31 – 35	200
905565	5,5 x 61	TX25	36 – 40	200

COURBARIL



ADVANTAGES / PROPERTIES

- Limited resistance to acid
- Suitable for use with woods containing tanning agents such as cumarú, oak, merbau, robinia, etc.
- Good resistance in moderately aggressive, non-chlorinated environments
- Suitable for saline atmospheres
- Stainless steel in accordance with DIN 10088

APPLICATION IMAGE



The profile drilling screw, stainless steel A4 is screwed into the Courbaril decking.

VISIBLE FASTENING

COURBARIL

ACCESSORIES FOR DIRECT/VISIBLE FASTENING

DISTANCE STRIP 2.0

For a visible fastening of boards, two screws must be used for board widths of 80 mm or more in the case of UK wood and UK aluminium profiles. The problem with this is that the screws work against each other when the wood expands or contracts, and this can quickly result in shearing of the screws.



Art. no.	Dimensions [mm] ^{a)}	Material	PU*
944803	30 x 700 x 7	Hard plastic	50

^{a)}Width x length x height

*Screws are not included.

Fastening with Terrasotec screws Ø 4 mm.

SHEARING

For this reason, Dista strips 2.0 should always be used for wood substructures or aluminium profiles with no screw channels in order to give screws enough clearance and minimise the risk of shearing.

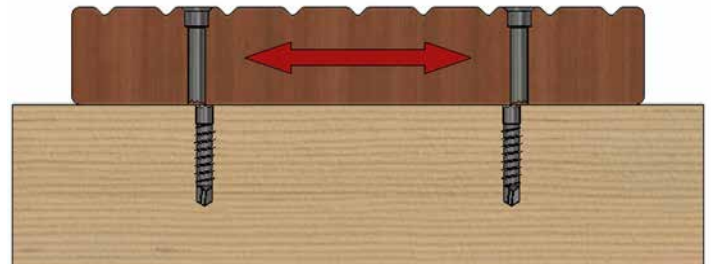

TERRASOTEC

Suitable for distance strip 2.0.

Art. no.	Dimensions [mm]	Drive	PU
905535	4,0 x 40	TX15●	500

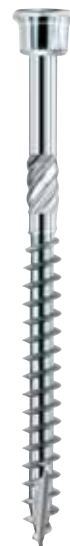

ADVANTAGES / PROPERTIES

- Limited resistance to acid
- 10 years experience without corrosion problems with suitable woods
- Not suitable for woods containing high amounts of tanning agents, such as cumarú, oak, merbau, robinia, etc.
- Not suitable for use in chlorous atmospheres
- Stainless steel in accordance with DIN 10088
- 50% greater breaking torque than A2 and A4
- Magnetizable

VISIBLE FASTENING

DETERMINE THE NECESSARY SCREW LENGTH

To determine the correct screw length for your particular terrace structure, a guide based on the professional rules of the carpentry trade is shown below.

TERRACES WITH WOOD SUBSTRUCTURE AND DISTA STRIP 2.0

To fasten terrace boards to a substructure, it is essential to select the correct screw length; failure to do so can impair the stability and service life of the terrace. Generally, the length of the screw must be at least double the thickness of the fixture (in this case, the thickness of the terrace boards). The screwed-in thread length must also be at least four times the nominal screw diameter; in the case of coniferous timber like Douglas fir, however, we recommend a minimum screw depth of six times the nominal diameter.

THE TOTAL LENGTH OF THE SCREW IS THEREFORE GUIDED BY THE FOLLOWING CRITERIA

COURBARIL

GENERAL

Only screws with a nominal diameter of 5 mm or more are to be used for the fastening. In outdoor areas, moreover, hardened stainless steel is the minimum requirement for the screw steel (even A2 or A4 stainless steel may be required, depending on the environment in which the terrace will be built).

Total length of screw

→ At least 2 x board thickness plus height of the Dista strip 2.0

Thread length in substructure

→ At least 4 x nominal screw diameter

Example calculation

Board thickness (T): 24 mm, nominal screw diameter (d): 5 mm

Height of Dista strip (D): 7 mm

$(2 \times 24 \text{ mm}) + 7 \text{ mm} = 55 \text{ mm}$

$4 \times \varnothing 5 \text{ mm} = 20 \text{ mm}$

$24 \text{ mm} + 7 \text{ mm} + 20 \text{ mm} = 51 \text{ mm}$

$51 \text{ mm} < 55 \text{ mm}$

Minimum length of screw: 55 mm

→ Screw length to choose: **60 mm**

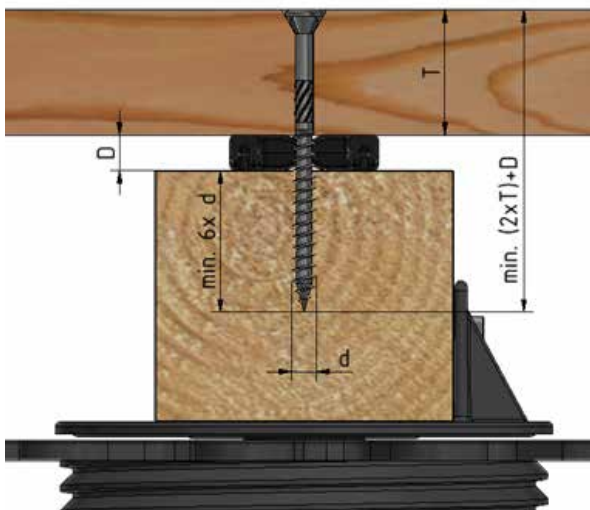

VISIBLE FASTENING

TERRACES WITH WOOD SUBSTRUCTURE AND DISTA STRIP 2.0

At this point it must be stressed that Eurotec does not recommend a terrace construction of this kind. This is because direct contact between the wood substructure and the boards creates a very large area in which waterlogging can form. As a result of this, the wood will rot and the service life of the terrace will be shortened significantly.

If you wish to go ahead with such a structure anyway, however, the requisite screw length is calculated as follows:

Total length of screw

→ At least 2 x board thickness

Thread length in substructure

→ At least 4 x nominal screw diameter

Example calculation

Board thickness (T): 24 mm, nominal screw diameter (d): 5 mm

$(2 \times 24 \text{ mm}) = 48 \text{ mm}$

$4 \times \varnothing 5 \text{ mm} = 20 \text{ mm}$

$24 \text{ mm} + 20 \text{ mm} = 44 \text{ mm}$

$48 \text{ mm} > 44 \text{ mm}$

Minimum length of screw: 48 mm

→ **Minimum screw length to choose: 50 mm**

TERRACES WITH ALUMINIUM SUBSTRUCTURE

Our profile drilling screw has been specially designed to fasten terrace boards on our aluminium system profiles. As a result, the screw length for this product is directly assigned to board thickness.

COURBARIL

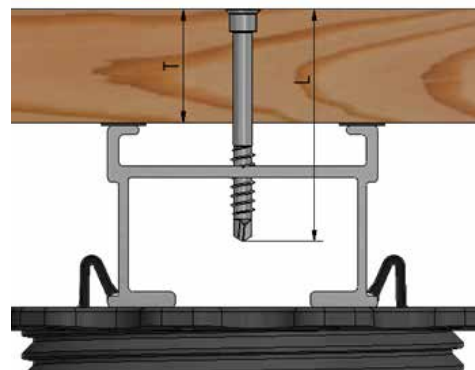
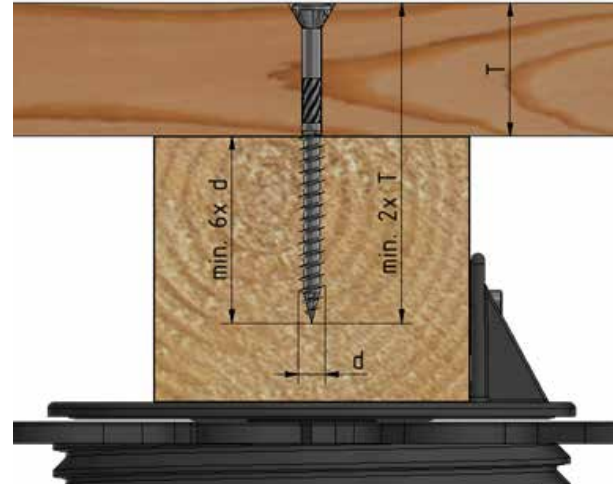

Profile drilling screw	
L [mm]	T [mm]
41	16 – 20
46	21 – 25
51	26 – 30
56	30 – 36
61	36 – 40

VISIBLE FASTENING

COURBARIL

THREAD LENGTH OF SCREWS

Terrasotec	
L [mm]	Lg [mm]
45	26
50	30
60	35
70	40
80	50
90	55
100	60

Hapatec	
L [mm]	Lg [mm]
45	26
45	28
50	30
60	36
70	42
80	48
90	54
100	60

Profile drilling screw	
L [mm]	Lg [mm]
41	21
46	21
51	21
56	21
61	21

L = nominal length of screw

Lg = thread length of screw

NUMBER OF SCREWS AND POSITION ACCORDING TO BOARD THICKNESS

For boards with a thickness of less than 80 mm, one screw per strand of the substructure is sufficient for fastening. Two screws must be used where the thickness is 80 mm or more.

The positions of the screws are determined by Eurocode 5 to ensure the longest possible service life of the connection elements used and the components affixed. For this reason we recommend a minimum spacing of 12 x the nominal diameter of the screw between screws and a spacing of 5 x the nominal diameter of the screw to the edge. (See illustration)

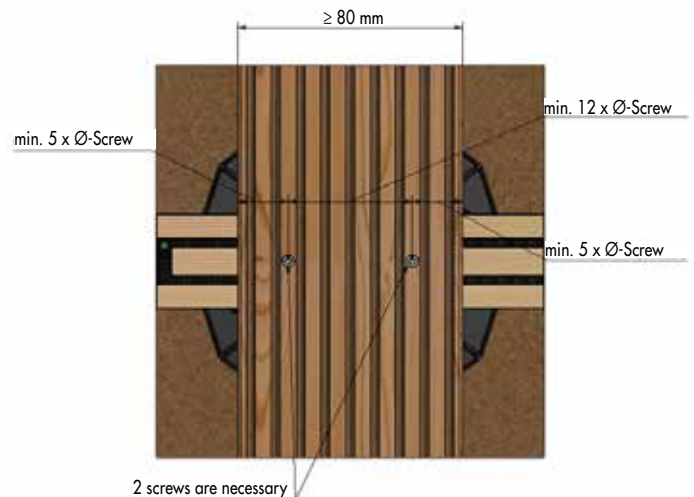

NOTES

To establish a crossed connection between the board and the substructure, it makes sense to use a minimum board width of 110 mm; otherwise the axis and edge distances may not be maintained.

If you are not familiar with how this product is used, and particularly with the product's intended use, please contact our Application Technology department (technik@eurotec.team).